



This is a digital copy of a book that was preserved for generations on library shelves before it was carefully scanned by Google as part of a project to make the world's books discoverable online.

It has survived long enough for the copyright to expire and the book to enter the public domain. A public domain book is one that was never subject to copyright or whose legal copyright term has expired. Whether a book is in the public domain may vary country to country. Public domain books are our gateways to the past, representing a wealth of history, culture and knowledge that's often difficult to discover.

Marks, notations and other marginalia present in the original volume will appear in this file - a reminder of this book's long journey from the publisher to a library and finally to you.

Usage guidelines

Google is proud to partner with libraries to digitize public domain materials and make them widely accessible. Public domain books belong to the public and we are merely their custodians. Nevertheless, this work is expensive, so in order to keep providing this resource, we have taken steps to prevent abuse by commercial parties, including placing technical restrictions on automated querying.

We also ask that you:

- + *Make non-commercial use of the files* We designed Google Book Search for use by individuals, and we request that you use these files for personal, non-commercial purposes.
- + *Refrain from automated querying* Do not send automated queries of any sort to Google's system: If you are conducting research on machine translation, optical character recognition or other areas where access to a large amount of text is helpful, please contact us. We encourage the use of public domain materials for these purposes and may be able to help.
- + *Maintain attribution* The Google "watermark" you see on each file is essential for informing people about this project and helping them find additional materials through Google Book Search. Please do not remove it.
- + *Keep it legal* Whatever your use, remember that you are responsible for ensuring that what you are doing is legal. Do not assume that just because we believe a book is in the public domain for users in the United States, that the work is also in the public domain for users in other countries. Whether a book is still in copyright varies from country to country, and we can't offer guidance on whether any specific use of any specific book is allowed. Please do not assume that a book's appearance in Google Book Search means it can be used in any manner anywhere in the world. Copyright infringement liability can be quite severe.

About Google Book Search

Google's mission is to organize the world's information and to make it universally accessible and useful. Google Book Search helps readers discover the world's books while helping authors and publishers reach new audiences. You can search through the full text of this book on the web at <http://books.google.com/>

W. L. SMITH & CO.,

HEADQUARTERS FOR

DIR. 275

KH161

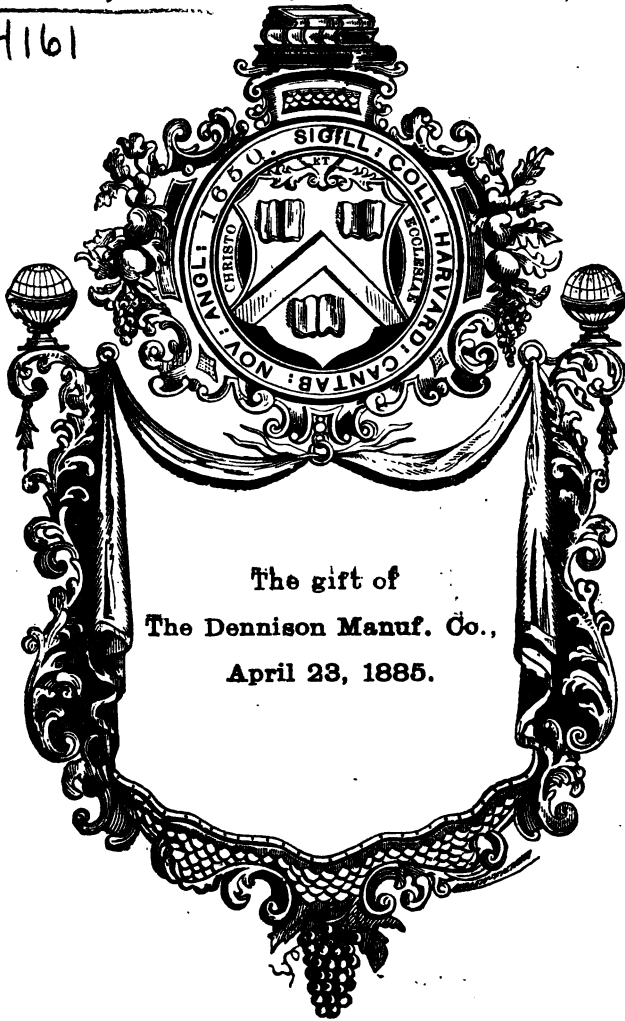

The gift of
The Dennison Manuf. Co.,
April 23, 1885.

Door to Post Office,

NORTHAMPTON,

MASS.

M. J. D. HUTCHINS,
LARGEST WHOLESALE AND RETAIL

MUSIC

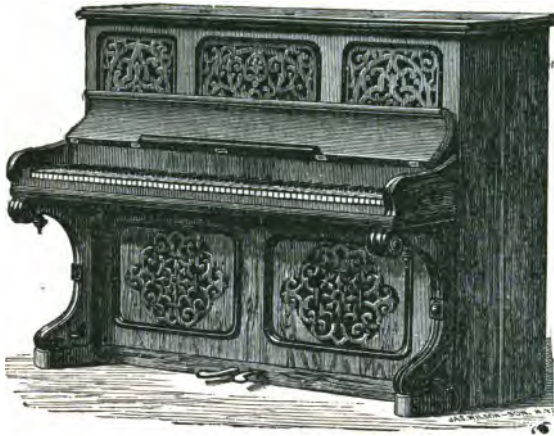

HOUSE

IN WESTERN MASSACHUSETTS.

— AGENTS FOR —

Chickering & Son's, Weber, Kranich & Bach, and Wheelock Pianos. Mason & Hamlin, Taylor & Farley and Estey Organs. Musical Merchandise a Specialty.

402 Main Street,
233 High Street,

SPRINGFIELD, MASS.
HOLYOKE, MASS.

Goods Rented, Exchanged and Sold on Instalments.

C. W. HUTCHINS,

Band Instruments AND Bicycle Bugles,

SPRINGFIELD, MASS.

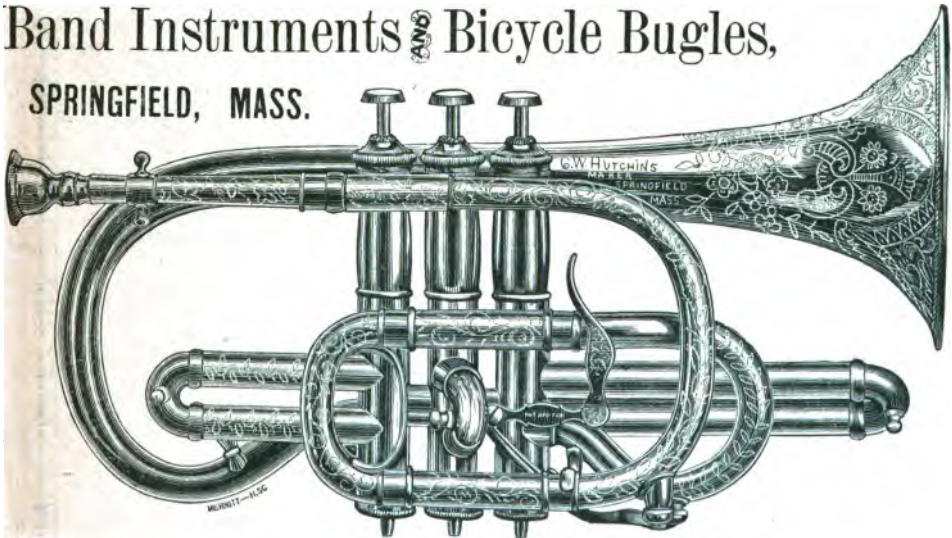

The Emerson Model Bb Cornet, with "The C. W. Hutchins' Patent Water Key," used and recommended by Walter Emerson. Sole manufacturer of the genuine Emerson Mouth-Piece; Gold plated, with fine case, \$2.50.
OFFICE, 402 MAIN STREET; FACTORY, TAYLOR STREET.
Proprietor C. W. Hutchins' Brass Band of 25 Pieces, and Drum Band of 20 Pieces
C. W. PERKINS, Manager.

R. F. HAWKINS' IRON WORKS,

Successor to Wm. Howe, Stone & Harris, and Harris & Hawkins.

WORKS ESTABLISHED, 1840.

*Howe Truss, Pin and Link, Riveted Lattice and Solid
Plate Girder*

BRIDGES,

Draw Bridges, Turn Tables, Bolts, Forgings,
R. R. Frogs and Switches,

STEAM BOILERS,

Tanks, and all Riveted Work,

Iron and Brass Castings. Building Fronts, Etc.

MACHINE AND BLACKSMITH WORK TO ORDER.

Office, 200 Liberty Street, - SPRINGFIELD, MASS.

R. F. HAWKINS,	PROPRIETOR.
C. H. MULLIGAN,	SUPERINTENDENT.
W. H. BURRALL,	ENGINEER

N. S. BEEBE,

MANUFACTURER OF

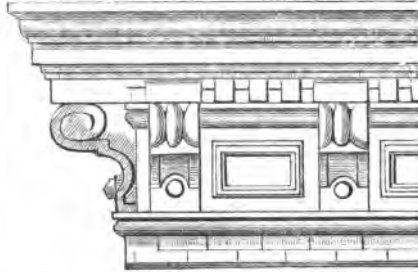

Galvanized Iron Cornices,

Gutters, &c. Dealer in Hot Air Furnaces,
Ranges and Stoves. Plumbing and
Plumbing Materials.

443 State Street, - - - SPRINGFIELD, MASS.

H. A. ROBINSON & SONS, LUMBER DEALERS

Kiln Dried Lumber and Hard Woods a Specialty.

Cor. Dwight and Lyman Sts., - SPRINGFIELD, MASS.

Orders by mail or telephone promptly filled.

H. A. ROBINSON.

H. W. ROBINSON.

G. E. ROBINSON

ESTABLISHED 1873.

PRICE, LEE & CO.,

DIRECTORY PUBLISHERS,

YALE BANK BUILDING,
Corner State and Chapel Streets, {

NEW HAVEN, CT.

The following Directories published annually at this office:

*New Haven, Bridgeport, Norwich, Waterbury, Meriden, Bristol, Plainville,
Southington, De by, Winsted and Torrington, in Ct.; Holyoke, Northampton,
Easthampton, Fitchburg, Clinton, in Mass.*

Directories of all the principal Cities on file and for sale.

One Dollar per year.

Single Copy, Ten Cents.

☞ SUBSCRIBE FOR

PRICE, LEE & CO'S

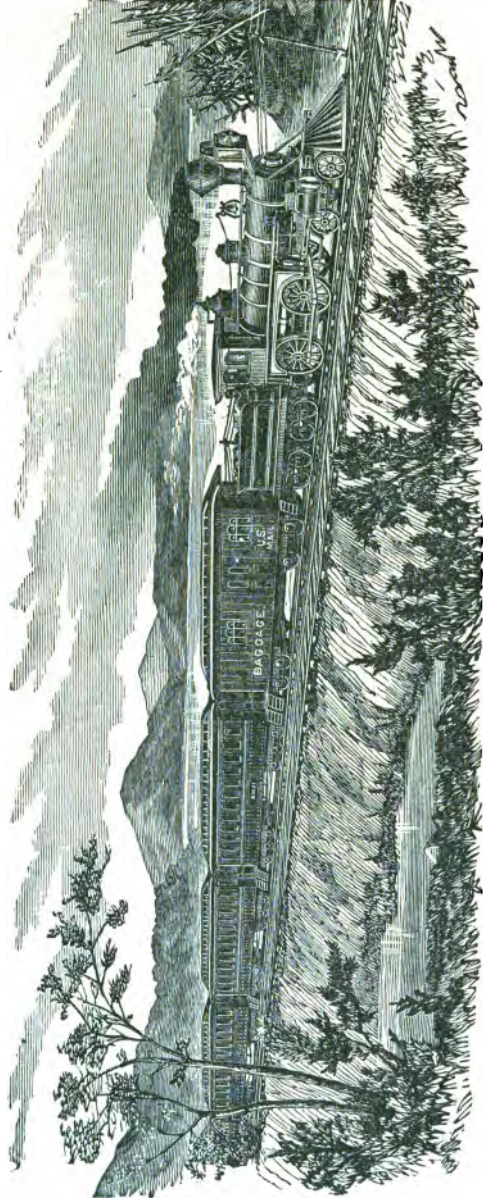

New England Railway Guide

Yale Bank Building, New Haven, Conn.

DENNISON MFG. CO.,

MANUFACTURERS OF

TAGS,

—AND—

Stationers' Specialties.

DENNISON'S TOURISTS' TAGS FOR TRAVELERS.

Stratton's Gummed Labels and Gummed Paper of all Colors; Legal and Notarial Seals; Folding and Fancy Tickets; Mentzel's Patent Suspension Rings; The Star Copying Pads; Dennison's Game Counters; Wedding Cake Boxes; Visiting and Playing Card Cases, Etc., Etc., Etc.

DENNISON'S TARGETS FOR RIFLE PRACTICE.

Phillips' Hook and Clasp Tags; Kimball's Self-Fastening Tickets; Postal Envelopes; McGill's Paper Fasteners at Manufacturer's discounts; Dickinson's Rubber Bands, Etc.

Sealing Wax Makers.

Tissue Papers.

Proprietors "Globe," and Centennial Prize "Excelsior," and Importers of English Grass Bleached and Colored Tissue Papers, from the celebrated 39 Mill.

Proprietors of "Silver White," best article for polishing Silver, and Miller's "Jewel-Cleaning Casket," and "Silver White Casket."

JEWELERS' BOXES,

Jewelers' Cards, Pink and White Cotton, Fine Twines, &c., &c.

DRUGGISTS' BOXES,

Apothecaries' Powder Papers and Counter Papers, Dennison's Shaving Papers.

Dennison's Absorbent Cotton, for Dental and Surgical Purposes.

CARD BOARD MAKERS.

All of our Goods are for sale by Dealers everywhere, and by

DENNISON MFG. CO.,

21 Milk St., Boston; 198 Broadway, New York; 630 Chestnut St. Philadelphia; 143 Walnut St., Cincinnati; 155 Dearborn St., Chicago; 412 3d St., St. Louis.

ADVANTAGES UNSURPASSED IN NEW ENGLAND.

G. C. HINMAN'S

SPRINGFIELD

BUSINESS

College

No. 419 Main St.

GET THE BEST

Book-Keeping,
Penmanship,
Arithmetic.

Business Paper,
Laws of Trade,
Business Letters.

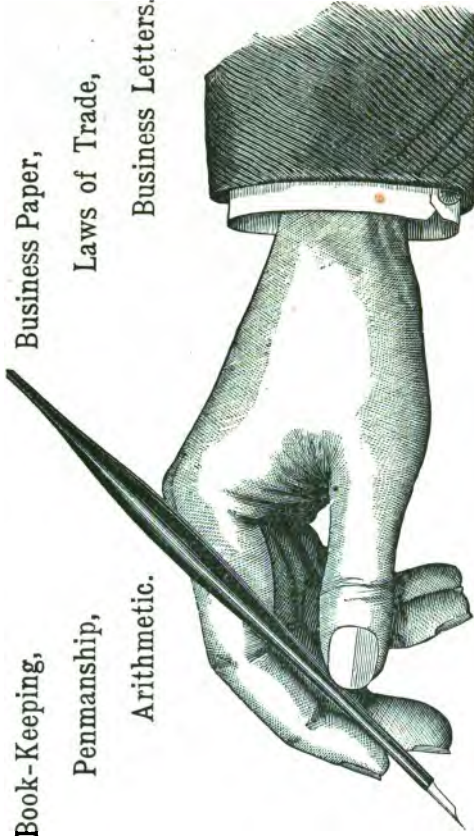

OUR BUSINESS COURSE.

Never in the history of business schools in this country has there been such careful throwing out of the useless, and getting the very best into a school course. It affords the most ample facilities for the practical education of persons of both sexes for the active duties of life. Instruction is given in every variety and style of Book-keeping, from its simplest to its most complicated forms. Penmanship is made a speciality, and no one passing through the entire course can fail of becoming an elegant, rapid business penman. Commercial Calculations, Business Correspondence, Mercantile Law, etc., are thoroughly taught. Send for Circulars.

G. C. HINMAN.

HAYNES & CO.,
— FOR —
FINE CLOTHING,

ALWAYS SHOWING BARGAINS THAT INTEREST
AND BENEFIT THE PEOPLE.

The Popular Clothiers,

— MEN'S AND BOY'S. —

HAYNES & CO.

PRICE, LEE & CO.'S
NEW ENGLAND RAILWAY GUIDE

ISSUED MONTHLY.

Containing Official Time Tables of all Railroads
in New England.

— PRICE ONE DOLLAR PER YEAR. —

SENT TO ANY ADDRESS.

SINGLE COPIES TEN CENTS.

PRICE, LEE & CO., Publishers,

Yale Bank Building,

NEW HAVEN, CT.

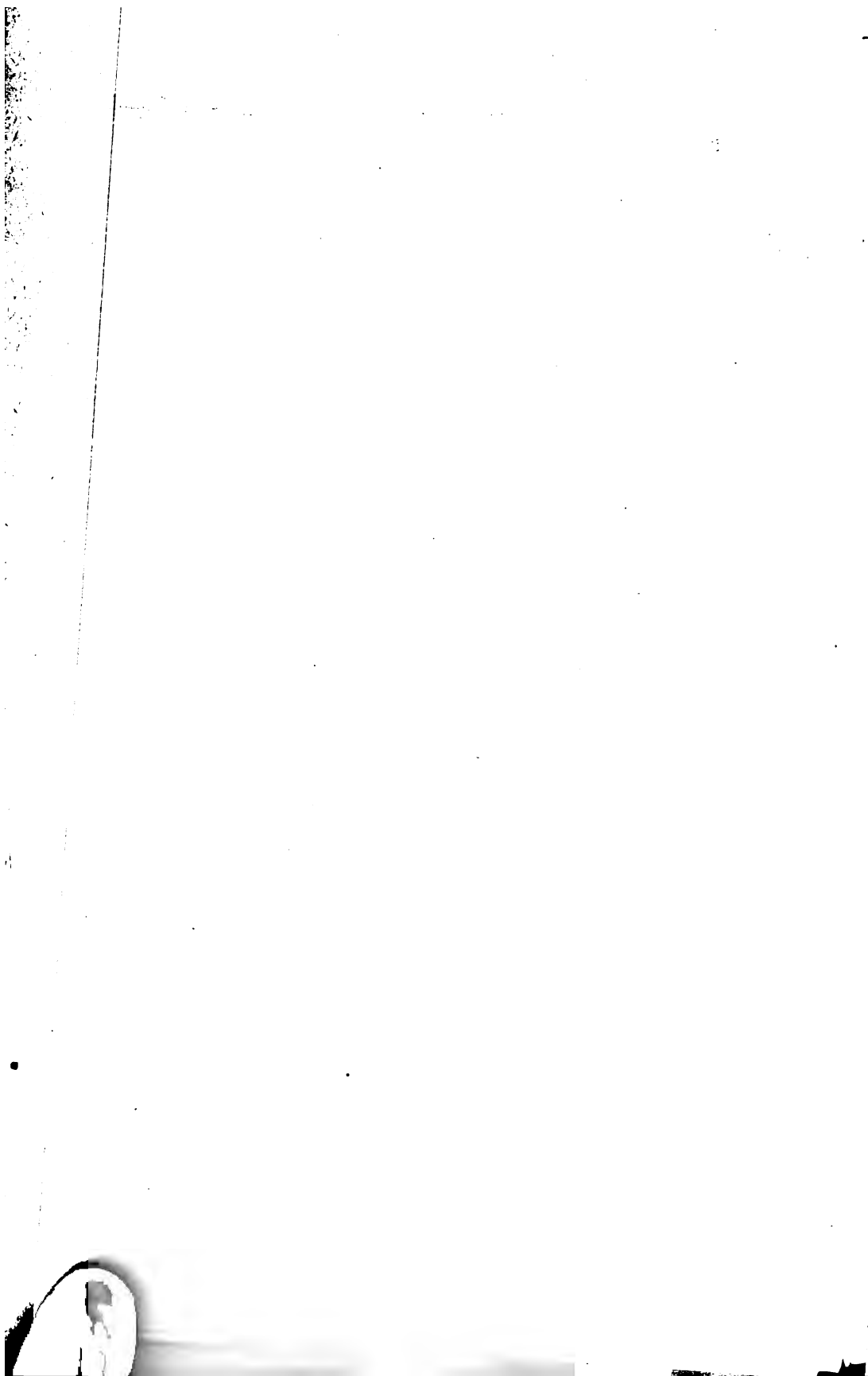

0

Northampton and Easthampton—
DIRECTORY,

1883-4.

CONTAINING

General Directory of the Citizens,

CLASSIFIED BUSINESS DIRECTORIES,

Street Directories, Town Officers, Churches,
Schools, Societies, &c.

PRICE, LEE & CO.,

COMPILERS AND PUBLISHERS,

GAZETTE PRINTING CO.'S OFFICE, NORTHAMPTON.

1883.

Printed by Gazette Printing Co., Northampton.

Entered according to Act of Congress in the year 1882, by Price, Lee & Co., in the office
of the Librarian of Congress, at Washington.

DIR 275

April 28, 1885.

CONTENTS.

PAGE.	PAGE.
Abbreviations, Northampton, .. 13	Masonic, Northampton, 154
Abbreviations, Easthampton, .. 173	Masonic, Easthampton, 221
Advertisements, 225	Miscellaneous Societies, North-
Blocks, Buildings, &c., North-	ampton, 156
ampton, 11	Miscellaneous Societies, East-
Blocks, Buildings, &c., East-	hampton, 221
hampton, 172	Names of Residents, North-
Business Directory, Northamp-	ampton, 13
ton, 115	Names of Residents Easthamp-
Business Directory, Easthamp-	ton, 173
ton, 205	Odd Fellows, 155
Churches, Northampton, .. 151	Post Offices, 168, 222
Churches, Easthampton, 220	Public Institutions, 158
Courts, 164	Public Libraries, Northampton, 158
County Officers, 164	Public Libraries, Easthampton, 221
Fire Dep't, Northampton, 149	Schools, Northampton, 150
Fire Dep't, Easthampton, 218	Schools, Easthampton, 218
Grand Army of the Republic, .. 155	Smith College, 159
Halls, Northampton, 12	Shady Lawn, 163
Halls, Easthampton, 172	Stock Companies, N'hampton, 165
Index to Advertisers, 3	Stock Companies, E'hampton, 223
Index to Out-of-town Adver-	Streets and Avenues, North-
tisers, 5	ampton, 9
Justices of the Peace, North-	Streets and Avenues, Easthamp-
ampton, 165	ton, 171
Justices of the Peace, East-	Town Officers, Northampton, 148
hampton, 217	Town Officers, Easthampton, .. 217
Knights of Honor, 155	Water Works, 150
Knights of Honor, Easthamp-	Williston Seminary, 219
ton, 221	Ward Boundaries... .. 7

SYNOPSIS.

Names in Northampton Directory, 1883,	4,744
Names in Northampton Directory, 1882,	4,170
Increase,	574
Names added in preparing Directory, 1883,	1,138
Names erased in preparing Directory, 1883,	564
Changes in address,	1167
Total number of changes,	2,869
Names in Easthampton Directory, 1883,	1,467
Names in Easthampton Directory, 1882,	1,267
Increase,	200
Names added in preparing Directory, 1883,	341
Names erased in preparing Directory, 1883,	140
Changes in address,	391
Total number of changes,	872

Index to Advertisers.

	PAGE		PAGE
Arms G. W.,	278	Footo E. N. & Co.,	286
Arnold J. W.,	282	French M. M. & Co.,	283
Barnes F. A. & W. E.,	256	Gabb Chas. N.,	288
Beldin H. L.,	303	Gaugh Fred. J.,	296
Belding Bros. & Co., outside front cover		Gazette Printing Co.,	opp. 49
Bernhardt John	284	Geron Henry,	269
Bosworth E. R.,	301	Glendale Elastic Fabrics Co.,	289
Brierly H. D. & Co.,	294	Graves M. L. & M. W.,	258
Bridgman S. E. & Co.,		Greenville Mfg. Co.,	240
opp. inside back cover		Guilford R. M. & Co.,	280
Brooks E. A.,	260	Hadley S. D. & Co.,	257
Brown Clarence E.,	240	Hall Edward P. & Co.,	267
Brown Rodney,	277	Hammond J. C.,	242
Brown R. D.,	244	Hampshire County Journal,	231
Brown & Bailey,	271	Hampshire Co. Mut. Fire Ins. Co.,	245
Bucknam H. S.,	274	Hampshire Co. National Bank,	229
Carley A. G.,	255	Hampshire Gazette,	230
Childs Henry,		Hampshire Herald,	232
inside back cover		Hampshire House,	277
Clapp Charles E.,	239	Hampshire Savings Bank,	226
Clapp Wm. D.,	265	Harlow C. N. & Co.,	268
Clark Charles N.,	243	Hathaway J. J.,	239
Clark Edson P.,	246	Hebert B & Son,	270
Clark F. L.,	295	Hebert Joseph,	268
Clark J. E.,	301	Herrick W.,	239
Clark & Parsons,		Hill William,	300
inside front cover		Hill & Wainwright,	243
Colton G. S.,	292	Holley H. G.,	282
Conn River Lumber Co.,	241	Hosmer P. P.,	257
Copeland E. P.,	252	Hotchkiss Wales,	246
Couture E.,	262	Howard M. C.,	250
Crittenden G. W.,	244	Howes E. B.,	273
Crouch C. S.,	270	Hoxie D. E.,	254
Crystal Emery Wheel Co.,	235	Huxley John,	269
Damon Narrow Fabric Co.,	237	Jackson M. W.,	262
Davis R. B. & Co.,	275	Jager J. C.,	276
Dearden William,	250	Jewett George D.,	269
Dewey P. H.,	283	Johnson C. B.,	295
Dickinson C. H.,	251	Jones W. H.,	244
Dickinson George F.,	274	Judd Wm. A. & Son,	296
Dickinson & Pomeroy,	279	Kaiser F. W.,	278
Donovan & Purcell,	261	Kellogg J. M.,	245
Draper John L.,	279	Kimball & Cary,	265
Eames & Sprague,	264	King A.,	241
Easthampton News,	286	Kingsbury A. & Son,	240
Easthampton Paper Co.,	292	Kinney C. W.,	272
Easthampton Rubber Thread Co.,	288	Knowlton J.,	257
Edwards Bros.,	260	Lamb Horace & Co.,	238
Edwards O. & Co.,	256	Lambie J. E. & Co.,	294
Fayhee S. S.,	300	Lambie J. E. & Co.,	249
Fearing & Everett,	249	Landy Bros.,	272
Ferry W. C.,	298	Lee & Day,	263
Field Zenas,	275	Lewis R. & Son,	261
First National Bank,	228	Lincoln & Bell,	248
Fish Francis W.,	263	Loomis G. L. & Co.,	259
Florence Mfg. Co.,	236		
Florence Savings Bank,	226		

Lord Jos. L.,	278	Ross E. S.,	261
Ludden E. H.,	298	Ruder Bruno,	284
Lyman & Shipman,	258	Rust T. & Sons,	260
Madison J. W.,	258	Rust, Wilson & Co.,	293
Mansion House,	277	Sackett R. W. & J. R.,	253
Mansion House, Easthampton,	300	Salois Joseph,	273
Marsh Joseph,	255	Searle & Edwards,	back cover
Mather J. L.,	271	Shaw George W.,	281
Maynard C. A.,	inside back cover	Sheehan Wm. J.,	299
McCallum A.,	243	Sherwin A.,	outside front cover
McCandless G. H.,	295	Simpson J. B.,	281
McCandless Wm.,	283	Skilton A. M.,	251
Meier Geo. A.,	300	Skiff James M.,	255
Menard A.,	246	Smith C. J.,	296
Morris F. G.,	295	Smith W. L. & Co.,	inside front cover
Murphy Joseph,	274	Smith & Jordan,	299
Nadeau Felix,	261	Smith & Livermore,	270
Nashawannuck Mfg. Co.,	291	Smith & Prindle,	252
Newkirk F. P.,	297	Snow C. A.,	246
Nonotuck Silk Co.,	outside back cover	Spaulding T. G.,	243
Northampton Cutlery Co.,	235	Stimpson C. N.,	front cover
Northampton Emery Wheel Co.,	234	Stocker A. H. & Co.,	251
Northampton Institution for Savings,	225	Stone John Q.,	244
Northampton National Bank,	227	Sullivan J. A.,	outside back cover
Norwood Ice Co.,	266	Taylor I. N.,	282
O'Donnel John B.,	243	Thompson A. W.,	163
Owen B. P.,	297	Topliff W. E.,	302
Parkhurst L. B.,	243	Towne J. M. & Sons,	259
Parnell James,	284	Tigerite Mfg. Co.,	258
Parnell John,	247	Tyler John,	278
Parsons H. K.,	253	Walker George H. & Co.,	256
Parsons S. L. & Son,	273	Walker Oliver,	245
Parsons & Crossley,	242	Warner Luther J.,	237
Phelps George S.,	275	Welch R. M.,	282
Phelps J. C.,	254	Wetherbee & Bemis,	298
Pierce C. H.,	245	Whipple George R.,	277
Pomeroy T. J. & H. F.,	299	Whitbeck George S. & Co.,	247
Pomeroy Wm. C.,	269	Whitcomb Horace,	282
Pratt W. F. & Son,	268	Whitlock T. G.,	288
Preston L. M.,	294	Wilder Samuel,	284
Prindle W. F.,	263	Williams Mfg. Co.,	253
Raffry Thos.,	262	Williston Mills,	287
Rice Benj. F.,	276	Williston & Knight Mfg. Co.,	290
Rice H. C.,	302	Wood E. T., Jr.,	280
Rich Martin,	292	Wood E. W.,	294
Richardson C. L.,	278	Wright D. J.,	255
Roberts E. A.,	254	Wright H. A.,	267
Rose S. C.,	275	Wright Henry A.,	266
Rosebush Gilbert,	276		

Out-of-Town Advertisers.

	PAGE		PAGE
<i>Art Store.</i>		<i>Clothes Line Wire.</i>	
Gill J. D., 340 Main, Springfield.....		Washburn & Moen Mfg Co., Worcester..	
outside front cover		back col'd page	
<i>Attorney-at-Law.</i>		<i>Clothiers.</i>	
Webster Allen, 438 Main, Springfield.....		Haynes & Co., 346 and 348 Main, Spring-	
outside front cover		field.....	map
<i>Band Instruments.</i>		<i>Coppersmiths.</i>	
Hutchins C. W., 402 Main, Springfield....		Emory P. P. & Co., 48 Hampden, Spring-	
front col'd page		field.....	309
<i>Barb Fencing.</i>		<i>Corset Wire.</i>	
Washburn & Moen Mfg Co., Worcester..		Washburn & Moen Mfg Co., Worcester..	
back col'd page		back col'd page	
<i>Bale Ties.</i>		<i>Crinoline Wire.</i>	
Washburn & Moen Mfg Co., Worcester..		Washburn & Moen Mfg Co., Worcester..	
back col'd page		back col'd page	
<i>Blank Book Manufacturer.</i>		<i>Crockery, China and Glassware.</i>	
Beldin H. L., 275 Main, Springfield.....	305	Quimby & Dearden, 328 Main, Springfield	305
<i>Boiler Makers.</i>		<i>Dandy Rolls.</i>	
Hawkins R. F. Iron Works, 200 Liberty,		Cheney Bigelow Wire Works, 26 to 32 Tay-	
Springfield.....	front col'd page	lor, Springfield.....	opp 2d p. Bus Dy
<i>Bookbinder.</i>		<i>Dentists.</i>	
Beldin H. L., 275 Main, Springfield.....	305	Holt & Waller, 352 Main, Springfield....	306
<i>Bookseller and Stationer.</i>		<i>Dining Rooms.</i>	
Gill J. D., 340 Main, Springfield.....		Barr E. C. & Son, 384 Main, Springfield.	307
outside front cover		<i>Dry Goods.</i>	
<i>Bottler.</i>		Forbes & Wallace, 390 & 392 Main, Spring-	
Hanrahan A., Taylor, Springfield.....	285	field.....	306
<i>Brass Founders.</i>		Meekins & Packard, 355 and 359 Main,	
Emory P. P. & Co., 48 Hampden, Spring-		Springfield.....	305
field.....	309	Tinkham & Co., 432 to 436 Main, Spring-	
<i>Brazier's Rod.</i>		field.....	back col'd page
Washburn & Moen Mfg Co., Worcester..		<i>Electrician.</i>	
back col'd page		Cutler H. M., 5 East Court, Springfield.	307
<i>Bridge Builder.</i>		<i>Electrotyper.</i>	
Hawkins R. F., Iron Works, 200 Liberty,		Van Vlack, Charles, Springfield.....	
Springfield.....	front col'd page	outside back cover	
<i>Broom Wire.</i>		<i>Engravers.</i>	
Washburn & Moen Mfg Co., Worcester..		Bolles F. Jr. & Co., 264 Main, Springfield	
back col'd page		back col'd page	
<i>Business College.</i>		<i>Fence Wire.</i>	
Hinman G. C., 419 Main, Springfield....		Washburn & Moen Mfg Co., Worcester..	
front col'd page		back col'd page	
<i>Cabinet Makers.</i>		<i>Foundry Riddles.</i>	
Prentice C. F., Taylor & Dwight, Spring-		Cheney Bigelow Wire Works, 26 to 32 Tay-	
field.....	303	lor, Springfield.....	opp 2d p Bus Dy
Springfield Cabinet, Joiner & Job Works,		<i>Force Pumps.</i>	
D. H. Joyce, propr., Taylor & Dwight,		Humphrey Machine, Keene, N. H.....	
Springfield.....	308	opp page	204
<i>Card Wire.</i>		<i>Furniture Spring Wire.</i>	
Washburn & Moen Mfg Co., Worcester..		Washburn & Moen Mfg Co., Worcester..	
back col'd page		back col'd page	
<i>Carpet Dealers.</i>		<i>Galvanized Iron Cornices.</i>	
Meekins & Packard, 355 and 359 Main,		Beebe N. S., 443 State, Springfield.....	
Springfield.....	304	front col'd page	
Tinkham & Co., 432 to 436 Main, Spring-		<i>Galvanized Wire.</i>	
field.....	back col'd page	Washburn & Moen Mfg Co., Worcester..	
<i>Caterers.</i>		back col'd page	
Barr E. C. & Son, 384 Main, Springfield.	307		

- Gents' Furnishing Goods.**
Haynes & Co., 346 & 348 Main, Springfield
map
- Hay Bale Ties.**
Washburn & Moen Mfg Co., Worcester..
back col'd page
- Ice Cream.**
Barr E. C. & Son, 384 Main, Springfield.. 307
- Iron Founders.**
Hawkins, R. F., Iron Works, 200 Liberty,
Springfield front col'd page
- Iron Wire.**
Washburn & Moen Mfg Co., Worcester..
back col'd page
- Iron Work for Buildings.**
Hawkins R. F., Iron Works, 200 Liberty,
Springfield front col'd page
- Lager Beer (Wholesale.)**
Hanrahan F., Taylor, Springfield 285
- Lithographers.**
American Photo-Lithograph Co., N. Y. ...
opp page 225
- Lumber Dealers.**
Robinson H. A. & Sons, Lyman corner
Dwight, Springfield, front col'd page
- Machinery Manufacturers.**
Humphrey Machine Co., Keene, N. H. ...
opp page 204
- Machinery Wire.**
Washburn & Moen Mfg Co., Worcester..
back col'd page
- Manufacturing Company.**
Washburn & Moen Mfg Co., Worcester..
back col'd page
- Market Wire.**
Washburn & Moen Mfg Co., Worcester..
back col'd page
- Merchant Tailors.**
Haynes & Co., 346 & 348 Main, Springfield
map
- Millinery.**
Forbes & Wallace, 390 & 392 Main, Spring-
field 306
Tinkham & Co., 432 to 436 Main, Spring-
field back col'd page
- Moulding and Brackets.**
Ferry C. S., Taylor c Dwight, Springfield 303
- Music Store.**
Hutchins M. J. D., 402 Main, Springfield
front col'd page
- Music Wire.**
Washburn & Moen Mfg Co., Worcester..
back col'd page
- Needle Wire.**
Washburn & Moen Mfg Co., Worcester..
back col'd page
- Paper Box Manufacturer.**
King J. B., 52 Taylor, Springfield 303
- Paper Hangings.**
Quimby & Dearden, 328 Main, Springfield 305
- Patent Solicitor.**
Webster Allen, 438 Main, Springfield....
outside front cover
- Pianos & Organs.**
Hutchins M. J. D., 402 Main, Springfield
front col'd page
- Plumbers and Plumbers' Supplies.**
Beebe N. S., 443 State, Springfield
front col'd page
- Rivet Wire.**
Washburn & Moen Mfg Co., Worcester..
back col'd page
- Rolling Mills.**
Washburn & Moen Mfg Co., Worcester..
back col'd page
- Round Iron.**
Washburn & Moen Mfg Co., Worcester..
back col'd page
- Scroll Sawing and Turning.**
Ferry C. S., Taylor c Dwight, Springfield 303
- Show Case Manufacturer.**
Prentice C. F., Taylor c Dwight, Spring-
field 303
- Silver and Plated Ware.**
Quimby & Dearden, 328 Main, Springfield. 305
- Speaking Tubes and Electric Bells.**
Cutler H. M., 5 East Court, Springfield. 307
- Spring Wire.**
Washburn & Moen Mfg Co., Worcester .
back col'd page
- Stationer.**
Gill J. D., 340 Main, Springfield.....
front cover
- Steel Barb Fencing.**
Washburn & Moen Mfg Co., Worcester..
back col'd page
- Steel Drill Wire.**
Washburn & Moen Mfg Co., Worcester..
back col'd page
- Steel Wire.**
Washburn & Moen Mfg Co., Worcester..
back col'd page
- Stone Wire.**
Washburn & Moen Mfg Co., Worcester..
back col'd page
- Tags.**
Dennison Mfg Co., Boston.....
front col'd page
- Telegraph Wire.**
Washburn & Moen Mfg Co., Worcester..
back col'd page
- Tinned Wire.**
Washburn & Moen Mfg Co., Worcester.
back col'd page
- Turbine Water Wheels.**
Humphrey Machine Co., Keene, N. H. ...
opp page 204
- Watch Springs.**
Washburn & Moen Mfg Co., Worcester..
back col'd page
- Weaving Wire.**
Washburn & Moen Mfg Co., Worcester..
back col'd page
- Wire.**
Washburn & Moen Mfg Co., Worcester..
back col'd page
- Wire Railings.**
Cheney Bigelow Wire Works 26 to 32 Tay-
lor, Springfield opp 2d p Bus D'y
- Wire Workers.**
Cheney Bigelow Wire Works, 26 to 32 Tay-
lor, Springfield opp 1st p Bus D'y
- Wood Engravers.**
Bolles F. Jr. & Co., 284 Main, Spring-
field back col'd page
- Wood Working Machinery.**
Humphrey Machine Co., Keene, N. H. ...
opp page 204

Ward Boundaries.

WARD ONE.—Commencing and including the house and land of Chas. Smith on Main St., thence crossing Main St. and dividing Masonic street, to Center, thence dividing Center St., to intersection of State St., thence dividing State St., past Park, Summer and Spring, to the Williamsburg railroad, thence northerly on line of N. H. & N. railroad to King St. road, to and across the bridge over said railroad, thence dividing bridge road to Slough Hill road, thence at the intersection of Slough hill and bridge road, northerly to Hatfield line, thence east on said line, to and dividing Connecticut river, southerly to a point at near right angles of the intersection of North St. and bridge road, thence to that intersection, thence to and including all the Mill Yard, so-called, to the Conn. River railroad, thence all southerly and westerly of said railroad, past Edwards, Bridge, Holyoke and Pleasant Sts., to Mill river, thence dividing Mill river, past South St. bridge, to a line parallel with the westerly line of Chas. Smith's land, to place of beginning, including all streets and parts of streets within the mentioned bounds and lands.

WARD TWO.—All northerly and westerly of ward one, following the dividing line and commencing at the westerly line of Chas. Smith's, on Main Street, thence dividing Masonic St. to Center, thence from Center to State, thence from State past Park, Summer and Spring to the Williamsburg railroad, thence on line of said railroad to and including the town farm, thence crossing Prospect St., to and dividing Franklin St. to Elm St., crossing Elm St. to northwesterly line of Daniel W. Clark's land, near land of H. G. Maynard, thence directly south to Mill river, thence southeasterly, dividing said river, to and near the Gas Works, or the westerly line of Chas. Smith's land, thence on the westerly line of Charles Smith's land to Main St., or place of beginning, including all of College avenue, Green St., West St., to the iron bridge, and all streets or parts of streets within the mentioned bounds and lands.

WARD THREE.—Commencing at the northwesterly corner of Bridge St., at the line of the Conn. River railroad land, thence on the line of said railroad land to and near the Mill Yard, so-called, land, thence northeasterly to the intersection of Bridge Road and North St., thence in a direct northeast line to the Connecticut river, thence dividing said river, past the

bridge, including Shepherd's island, to and past Hockanum ferry to the mouth and center of Mill river, thence dividing said river to the Conn. River railroad bridge, near Pleasant St., thence crossing Pleasant St. to and on the line of the Conn. River railroad land, past Holyoke St., to Bridge St., crossing Bridge St. to place of beginning, including all streets, parts of streets, and all lands easterly of the Conn. River railroad, with the exception of the Mill Yard and land northwesterly of the before mentioned intersection of North St. and Bridge road, within the mentioned bounds.

WARD FOUR.—Commencing at the middle of the Mill river, near South St. bridge, thence southerly, dividing said river to its mouth at Connecticut river, thence down Connecticut river to boundary line between Northampton and Easthampton, thence all of that part of the town known as Smith's Ferry, to and including land near Mt. Tom station, thence to the southeasterly line of Northampton and Easthampton, thence westerly on the boundary line past all roads to and near the southwesterly line of Emerson Searle's land on Park Hill, north to West Farms road twenty rods west of James Ryan's house on said road, thence northeast to the road leading from Florence to Easthampton, to the intersection of the Old Burt's Pit road, southerly of the premises of Patrick Kairn's, thence from that intersection northeasterly to Mill river, above and near the Northampton cutlery shops, thence easterly and southerly, dividing Mill river, to and past West St. bridge, to the place of beginning at South St. bridge, including all streets, parts of streets, all of South Farms, Pine Grove, Hospital Hill, and all lands within the mentioned bounds.

WARD FIVE.—Commencing at the southeasterly line of Ward Two, at Mill river, thence north to northwesterly line of Daniel W. Clark's land on Elm St., thence crossing and dividing Franklin St. to Prospect St. thence crossing Prospect to northwesterly line of Town Farm, thence northeast to the Bridge road, near where it crosses the N. H. & N. railroad, thence dividing Bridge road to Slough hill road, near the intersection of Slough hill and Bridge road, thence direct north to Hatfield boundary line, thence direct west on said boundary line two hundred rods, thence southwesterly to Bridge road to and including the house and premises of

Wm. N. Moore, thence to and including Holyoke St., with the buildings and lots of land, to Prospect or Locust Sts., thence including all houses and lots on Holyoke St. to Main St., thence crossing Main St. running a parallel line to Beacon St. crossing Beacon and running a parallel line to Nonotuck St., thence northwesterly all of Nonotuck St. houses and lands connected, to the intersection of Nonotuck and Landy Sts., thence dividing Landy St., to intersection of Landy St. and road leading to Bay State, thence parallel line with Landy St. to Mill river, thence southerly and easterly, dividing Mill river to place of beginning or place named on Mill river, near southwest corner of Ward Two, including all streets, parts of streets, Paper Mill Village, Bay State Village, Catholic cemetery, and all lands within mentioned bounds.

WARD SIX.—Commencing near the intersection of Main and Holyoke Sts., on the northwesterly line of Ward Five, thence northerly near Holyoke and on said line of Ward Five to Bridge road, thence northerly, westerly and southerly, to include all of the Fairbanks farm, so-called, thence crossing Bridge road parallel to the easterly line of Galusha Miller's land, thence along said Miller's land, and on land of Emily K. Sheffield, to a point at right angles with Myrtle St., thence to North Maple St. at the intersection of Myrtle St., thence to Main St., thence dividing Main to Meadow St., thence dividing Meadow St. to the bridge near Austin Ross on Mill river, thence dividing Mill river to the iron bridge near the brush factory on West St., thence dividing West St. to West Farms, crossing the West Farms road leading to Roberts Meadow near the house of Hiram Stebbins, thence dividing the road leading westerly to the Westhampton town line, thence south on the boundary line between Northampton and Westhampton, to Loudville, or the southwest corner of Northampton, thence east on Northampton and Easthampton boundary line to southwesterly line of Emerson Searle's land at Park Hill, or to the southwesterly boundary line of Ward Four, thence north on Ward Four line to West Farms road at a point on said road twenty rods west of James Ryan's house, thence northeast on Ward Four line to the intersection of the road leading from Florence to Easthampton at the intersection of the old Burt's Pit road, thence from that intersection along the line of Ward Four to Mill river above and near the Northampton cutlery shops, thence northerly dividing Mill river to a point

on said river at right angles with Landy St., or on the line of Ward Five to the road leading from Florence to the Bay State Village, crossing said road at the intersection of Landy St., dividing Landy St. to Nonotuck St., crossing Nonotuck St. on a line parallel with Landy St., running about fifteen rods northeasterly to a point between Nonotuck and Beacon Sts. on the line of Ward Five, thence southeast dividing equally the land between Nonotuck St. to the line of Ward Five, thence northeasterly to and across Beacon to Main St. near the intersection of Main and Holyoke Sts., or place of beginning, intending and meaning to include Loudville, part of West Farms, and all streets, parts of streets, all roads and parts of roads, and all lands within the mentioned bounds.

WARD SEVEN.—Commencing at the intersection of Main and North Maple Sts. thence north, dividing North Maple to the intersection of Myrtle St., thence east to a point on Emily K. Sheffield's land at right angles with the east line of Galusha Miller's land, thence north to and along the easterly line of said Miller's land, crossing Bridge road to the land of the Chase or Fairbanks farm, thence northerly, not including any of said farm, thence easterly on line of said farm to and intersecting the westerly line of Ward Five, thence north on Ward Five boundary to dividing line between Hatfield and Northampton, to a point, thence west on said line to the boundary line between Northampton and Williamsburg, thence west to the northwest corner of this town's boundary, thence south to and crossing the Roberts Meadow road at the intersection on the line between Northampton and Westhampton, crossing said road, thence south on the boundary line between Northampton and Westhampton, to the intersection of the road leading east to West Farms, thence dividing said road to West Farms, crossing the road leading from West Farms to Roberts Meadow, thence dividing the road or street called West St., to the bridge on Mill river at the bridge near the brush factory, thence northwesterly dividing Mill river to Meadow St. bridge, thence northerly from the bridge dividing Meadow St. past Lily St. to Main St. at the intersection of North Maple St. to place of beginning, meaning and intending to include part of West Farms, Roberts Meadow, North Farms, part of Florence and Leeds, and all streets, parts of streets, all roads and parts of roads, and all lands within the mentioned bounds.

Streets and Avenues.

NORTHAMPTON.

ALLEN, from King to Gothic.
ARLINGTON, from 24 Franklin, west.
BANK, from King, n Main.
BATES, from North at junction of Lincoln Avenue, to Water.
BRIDGE ROAD, from North King to Florence and Williamsburg.
BRIDGE, from Main at R. R. Crossing to Hadley Bridge.
BRIGHT, from King to State.
CEMETERY ROAD, from North Prospect to Bridge Road.
CENTER, from Main to State.
CENTER AVENUE, from Center opp. Masonic.
CHERRY, from 31 Market to Pine.
CHESTNUT, from 59 Prospect to State.
CLARK AVENUE, from 17 South to lower Grist Mill.
CLEMENT, from West, beyond bridge.
COLLEGE AVENUE, from Elm south to Green.
COTTAGE PLACE, from 3 Clark Avenue, north.
COURT, from King to Gothic.
CRAFTS AVENUE, from Main at Town Hall to River.
EDWARDS, from King to Market.
ELM, from Main Northwest to Main, Florence.
FACTORY, from West near Bridge to Green.
FORT, from 60 South to Meadows.
FRANKLIN, from 59 Elm north to Prospect
FRANKLIN AVENUE, from 44 South.
FRONT, from 29 William.
FRUIT, from 12 South.
GOTHIC, from Main to Park
GRANT AVENUE, from 56 Bridge.
GREEN, from West to College Avenue.
HANCOCK, from 14 Hawley to Pomeroy Terrace.
HAWLEY, from 1 Bridge to Holyoke.
HENSHAW AVENUE, from 27 Elm north.
HIGH, from 36 South.
HOCKANUM ROAD, from Pleasant c Williams.
HOLYOKE, from Pleasant to Williams.
HOSPITAL HILL, from West.
KING, from Main to North King.
KIRKLAND AVENUE, from Pleasant.
LAWN AVENUE, from Prospect.
LINCOLN AVENUE, from 60 Bridge to Bates.
MAIN, from Bridge west to Elm.
MAPLE, from South towards Mt. Tom Station.
MARKET, from Bridge to North.
MASONIC, from 205 Main north to Center.
MASSASOIT, from 83 Elm north to Prospect.
MILL, from Elm at brickyard to Vernon Bros.' mill.
MILL YARD, off King near Catholic Church.
MYRTLE, from 60 King to State.
NORTH, from Market and Pine Avenue to Bates.
NORTH ELM, from Elm to Locust, Florence.
NORTH KING, from King to Hatfield town line.

OLIVE, from 80 South.
 PARADISE, from 44 Elm south.
 PARK, from King to Prospect.
 PEARL, from 30 Pleasant to Strong Avenue.
 PERKINS AVENUE, from 100 State to Prospect.
 PHILLIPS PLACE, from Hawley to Pomeroy Terrace.
 PINE, from 28 Bridge to North.
 PLEASANT, from 44 Main,
 POMEROY TERRACE, from 29 Bridge to Hancock.
 PROSPECT, from Elm north and west beyond Massasoit.
 RAILROAD AVENUE, from Holyoke to Conn R. R. depot.
 RIVER, from Pleasant to South.
 ROUND HILL, from Elm to Prospect.
 SANDERSON AVENUE, from 12 Franklin.
 SCHOOL, from 28 South to near lower grist mill.
 SHORT, from Pleasant to Railroad Avenue.
 SLAUGHTER ROAD, from Prospect to Johnson's slaughter-house.
 SMITH, from Fruit to basket shop.
 SOUTH, from Main to Easthampton line.
 SPRING, from King to Prospect.
 STATE, from Main to N. H. & N. R. R.
 STRONG AVENUE, from Main south to Pearl.
 SUMMER, from 36 King to Prospect.
 UNION, from 15 Market to Pine.
 VERNON, from 88 Elm to Washington Place.
 WALNUT, from 41 Market to Pine.
 WASHINGTON AVENUE, from 64 Elm to Washington Place.
 WASHINGTON PLACE, from 35 Washington avenue to Vernon.
 WATER, from Bridge to King.
 WEST, from junction Main and Elm to Day's Brick yard.
 WILLIAMS, from Hancock to Pleasant.
 WINTER, from 63 Prospect to N. H. & N. R. R.

FLORENCE.

BEACON, from 31 Pine east to Main.
 BRIDGE, from Nonotuck south to Water.
 BRIDGE ROAD, from Northampton bridge west to Leeds.
 CENTER, from Maple east to Chestnut.
 CHESTNUT, from Pine northeast to Bridge.
 FRUIT, from 16 Main north to High.
 HICKORY, from Oak west to Lake.
 HIGH, from North Maple east to Holyoke.
 HOLYOKE, from Main near Beacon north.
 LAKE, from Myrtle north to Bridge Road.
 LANDY AVENUE, from Nonotuck south to River.
 LILY, from 24 North Main to Meadow.
 LOCUST, from Main opp Pine east to Prospect, Northampton.
 MAIN, from junction Meadow and North Main southeast to Elm, Northampton.
 MAPLE, from Water north to Main.
 MEADOW, from Main southwest to Spring.
 MYRTLE, from North Main east to North Maple.
 NONOTUCK, from Spring east to Main.
 NORTH MAIN, from junction Main and Meadow north to Bridge Road.
 NORTH MAPLE, from Main north to Bridge Road.
 OAK, from Myrtle north to Bridge road.
 PINE, from Main west to Nonotuck.
 PROSPECT, from Nonotuck opp. silk factory north to Meadow.
 RIVER, from Nonotuck near Bridge south to Bay State.

SOUTH, from junction Spring and Nonotuck south.
 SPRING, from junction South and West northwest to Leeds.
 WATER, from Bridge east.
 WEST, from junction South and Spring west to West Farms.
 WEST CENTER, from Maple west to Park.

LEEDS.

BRIDGE, from Main west to Water.
 CENTER, from Grove Avenue east to Front.
 CHESTNUT AVENUE, from Front north to High.
 CHESTERFIELD ROAD, from junction Main and Spring, (Florence) west to town line.
 CRITCHLOW, from Florence to railroad.
 FLORENCE, from depot southeast to North Main, Florence.
 FRONT, from depot north and east to Haydenville Road.
 GROVE AVENUE, from Front north.
 HAYDENVILLE ROAD, from Florence north to Haydenville.
 HIGH, from Grove Avenue east to Front
 LEONARD, from Front west to Haydenville Road.
 MAIN, from Florence line west and north to Nonotuck.
 NONOTUCK, from depot northwest to junction River and Reservoir Road.
 RESERVOIR ROAD, from Nonotuck west to Chesterfield Road.
 RIVER ROAD, from Nonotuck north to Haydenville.
 SPRING, from Main southwest to Chesterfield Road.
 WARNER'S ROW, from Florence south to railroad.
 WATER, from Nonotuck west end Bridge south.
 WEST, from junction River Road and Reservoir Road west to Williamsburg.

BAY STATE.

FEDERAL, from Vernon to Main, Florence
 HIGH, from Main north.
 HINCKLEY, from Main north to Nonotuck, Florence.
 MAIN, from Elm opp. brickyard west to N. Cutlery works.
 MAPLE, from Main north to Hinckley.
 NORWOOD AVENUE, from Main northeast.
 RIVER, from Florence line south to Main
 UNION, from Main south to Mill River.
 WARNER, from——west.

BLOCKS, BUILDINGS, &c.

Carr's Block, 149 to 151 Main.
 Clapp & Johnson's Block, 109 Main.
 Clarke Block, 56 to 60 Main.
 Cook's Marble Block, 72 Main.
 County Court House, Main cor. Gothic.
 Cutler's Block, Maple cor, West Center, Florence.
 Damon's Block, 103 to 107 Main.
 Davis Block, Main, Florence.
 Dawson's Block, 6 to 8 Main.
 Dickinson's Block, 20 to 24 Main.
 First National Bank Building, Main cor. King.
 Hampshire County National Bank Building, 112 Main.

Hillyer's Block, Main cor. South.
Jones' Block, Court near King.
Kirkland's Block, 50 and 52 Main.
Little's Block, Main, Florence.
Mansion House Block, 125 to 143 Main.
McCallum's Block, 114 and 116 Main.
Merritt Clark's Block, 108 and 110 Main.
Northampton National Bank Block, 99 and 101 Main.
Opera House Block, 118 to 124 Main.
Parsons' Block, 90 to 92 Main.
Parsons' (Enos) Block, Main cor. Pleasant.
Pierce's Block, 169 to 171 Main.
Rust's Block, 159 to 163 Main.
Savings Bank Building, Main cor. Gothic.
Smith's Block, Court cor. Gothic.
Southwick's Block, 62 to 64 Main.
Thayer's Block, 26 to 30 Main.
Todd's Block, 115 to 121 Main.
Union Block, 181 to 193 Main.
West Block, River.
Williams Block, 143 to 147 Main.
Wright's Block, 195 to 213 Main.

HALLS.

Central Hall, 52 Main.
Cosmian Hall, Main, Florence.
Davis Hall, Main, Florence.
Maloney's Hall, 131 Main.
Masonic Hall, 199 Main.
Memorial Hall, Main opp. Masonic.
Music Hall, 62 Main,
Northampton Opera House, 120 Main.
Odd Fellows' Hall, 58 Main.
Philharmonic Hall, 151 Main.
Rust's Hall, 161 Main.
Southwick Hall, 62 Main,
Temperance Hall, Williams Block, Main.
Town Hall, Main cor. Craft's avenue.
Williams Hall, 147 Main.

Northampton Directory.

1883-4.

ABBREVIATIONS.

h, house ; c, corner ; bds, boards ; blk, block ; n, near ; opp, opposite ; ab, above ;
res, residence ; r, rear ; bdg, building ; av, avenue ; adv, advertisement ;
mfr, manufacturer ; dep't, department ; p, page ; emp, employed ; mfg,
manufacturing ; N, north ; S, south ; E, east ; W, west ; F, Florence ;
B B & Co, Belding Bros & Co ; C. Mfg Co, Clement Manufacturing
Co ; W & C, Watson & Chamberlain ; W Mfg Co, Williams
Mfg Co ; C R L Co, Connecticut River Lumber Co ; N.
L. H., Northampton Lunatic Hospital ; F F Co,
Florence Furniture Co ; N Cutlery Co, North-
ampton Cutlery Co ; N S Co, Nonotuck Silk
Co ; G Mfg Co, Greenville Mfg Co ; F
M Co, Florence Machine Co.

ABBEY WELLINGTON F., wheelwright, bds 14 Main F
Abbott George I., travelling salesman, rooms 35 South
Abbott Hubbard M., deputy collector 10th district, County Court
House, bds 12 West
Abbott Nathan P., overseer N Silk Co., h Park F
Abell Wealthy, widow Asahel S., h 7 Park
Abell Edward, bds 38 Market
Abell Henry H., carpenter, h 38 Market
Abercrombie E. L., harness maker, Main c Maple, h 7 Main, F
Abercrombie Joel, truckman, h 7 Main, F
Abrams Ellen, widow Richard, h 5 Valley
Acklesley James, emp B B & Co., bds Holyoke c Williams
Adams Adolphe, emp W Mfg Co., h Smith
Adams A. T. Mrs., bds 29 Elm
Adams Charles, Hubbard House, Smith College
Adams Charles, h Bates
Adams Edward, mechanic, rem to Springfield
Adams Ellen Mrs., h Myrtle
Adams Euzeme, emp W Mfg Co., h Rust's blk, South
Adams Horatio W., book keeper Cutler, Plimpton & Co., h Pine, F

- Adams John D., machinist Northampton Emery Wheel Co., h Front, Leeds.
- Adams John J., blacksmith B. M. Couch, bds High n R. R., F
- Addis Edwin J., carpenter, h Leonard, Leeds
- Agard Isaac M., teacher High School, h 26 Pleasant
- Ahearn James, teamster Searle & Edwards, h 16 Walnut
- Ahearn John, bds Spring, F
- Ahearn Lawrence, laborer, bds Spring F
- Ahearn Michael, laborer, h Hinckley, Bay State
- Ahearn Michael, farmer, h Florence, Leeds
- Ahearn Morris, engineer H. W. Clapp, h King
- Ahearn Patrick, teamster W. L. Smith & Co., h 9 Hawley
- Ahearn Patrick, emp Mill River Button Co., h Water, Leeds
- Ahearn Thomas F., F. M. Co., h Spring, F
- Aiken Olive Mrs., emp N. Silk Co., bds Nonotuck, Leeds
- Aldrich Allen, attendant N. L. Hospital, bds do
- Aldrich Jonathan J., carpenter, h Fort
- Aldrich Robert, farmer, h West Farms
- Aldrich Robert H., h Spring
- Aldrich William O., rem to Springfield
- Almshouse, Prospect n Franklin
- Allaire Andrew, emp Northampton Emery Wheel Co., h 32 Williams
- Allair Phelix, rem to Montreal
- Allard Edward, carpenter, rem to Whitehall, N. Y.
- Allen Amazi, h 25 North Main, F
- Allen Bennett, carpenter, h North Main, F
- Allen Clara and A. Misses, h 17 King
- Allen Charles M., mechanic Florence Machine Co., h Summer
- Allen E. Mrs., rem to Williamsburg
- Allen E. Edward, clerk, h Prospect c Hinckley
- Allen Elijah, farmer, h 43 Elm
- Allen Eliza A. Mrs., h North Elm
- Allen George P., printer Hampshire Gazette, bds 10 River
- Allen James, wire drawer, bds 13 River
- Allen James L., laborer, Oak, F
- Allen J. Edward, rem to Torrington, Ct.
- Allen John, laborer, h King c North
- Allen Mary P., widow Wallace W., h Lilly n Meadow, F
- Allen Merwin, farmer, h North
- Allen S. Mrs., h 23 North Main, F
- Allen Wallace, emp Nonotuck Silk Co., bds Lilly n Meadow, F
- Allen William, Judge Supreme Judicial Court, h North
- Allen William, engineer C R. R. R., bds 22 Market
- Allis Austin J., farmer, h North Farms
- Allis Luther A., farm hand, bds North Farms
- Alvord Ann W. Mrs., h 70 South
- Alvord Clinton, bds 45 Bridge
- Alvord Dorus H., carpenter, h Maple, F
- Alvord D. W. Mrs., h 45 Bridge
- Alvord Frank C., laborer, h Hospital Hill
- Alvord James C., student, bds 45 Bridge

Alvord Nancy Mrs., h 4 Park
 Alvord Sarah, widow Nelson, h 11 Clark avenue
 American Express Co., H. W. Dewey, Agt., 26 Main. W. L. Wilcox,
 Agt., N. H. & N.R.R. Depot, Florence. S. L. Bolter, Agt. Leeds
 Amherst, Hadley & Northampton Stage Line, E. F. Cook, prop.,
 Mansion House
 Anderson James, shoemaker, Davis Block Main, F, h do
 Anderson Margaret, widow John, h West, F
 Andrus Frank W., emp G Mfg Co., bds Nonotuck, F
 Andrus Joseph W., master mechanic G Mfg Co., h Nonotuck, F
 Angell Charles, farmer, bds West Farms
 Angell Ira, farmer, bds West Farms
 Angell James M., farmer, h West Farms
 Angell Jesse F., foreman carding dep't G Mfg Co., h 2 Nonotuck, F
 Angell John H., rem to Springfield
 Angevine Sarah E. Mrs., h 28 Center
 Appio John, laborer, h Easthampton road
 Archambeau A., painter, h Hawley, opp B B & Co
 Archibald Fannie Miss, bds 43 Bridge
A RMS GILBERT W., laundry, Bridge cor Lincoln avenue, h do
 [See p 278.]
 Armstrong John, emp B B & Co., h 40 Williams
 Arnold Charles F., carpenter, h River
A RNOLD J. W., paper broker, office 90 Main, N, h 40 Pine F
 [See p 232.]
 Arnold William F., h 6 West
 Askins Luther B., brush maker, h Nonotuck, F
 Askins Sarah Mrs., h Nonotuck, F
 Assing August, tailor, Maple, Florence, h do
 Assing August Jr., emp Nonotuck Silk Co., h Lilly F
 Assing Christie, emp F M Co., bds Maple, F
 Atkins Fred T., emp Nonotuck Silk Co., bds 18 Pine, F
 Atkins James D., foreman dyeing dep't N Silk Co., h 18 Pine, F
 Atkins William M., teamster, M. L. & M. W. Graves, h West
 Austin Frank, painter, bds 7 Main, F
 Austin Fred, emp F Machine Co., bds 7 Main
 Austin Leavitt B., rem to Malone, N. Y.
 Averill Amy S. C. Mrs., h Round Hill
 Averill Geo. C., teller First Nat'l Bank, h Paradise road
 Avery Edwin P., book-keeper, N. S. Co., h Maple, c Pine, F
 Ayer Henry, grinder, bds Hinckley, Bay State
 Ayer John, grinder, h Hinckley, Bay State
 Ayer William, grinder, bds Hinckley, Bay State
 Ayres Ariel S., farmer, h 68 North Maple, F
 Ayres Austin W., button mfr and hat bleacher, h Pine n Cherry
 Ayres Carey, emp W Mfg Co., bds 53 Pleasant
 Ayres Geo A., casket maker, h Meadow, F
 Ayres Herbert C., driver Am. Ex. Co., h 28 Cherry
 Ayres John H., emp F Mfg Co., h Spring, F

BACK ADNA, overseer Nonotuck Silk Co., h Main n Nonotuck, F
 Backum John C., nurse, bds Hampshire House
 Backus Clarence, nickel-plater, F Machine Co., bds Pine, F
 Backus Gurdon, blacksmith, Nonotuck, h Pine, F
 Backwell Charles, inspector C Mfg Co., Bay State, rooms 28 Main
 Bacon Annie B. Miss, music teacher, bds Prospect n Park
 Bacon Elizabeth J., widow David, h Myrtle
 Bagley John, laborer, h Bates n Lincoln av
 Bailey Benjamin F., manager Northampton Beef Co., h 18 Hawley
 Bailey Betsy Mrs., bds Park opp W Center, F
 Bailey Clara, widow John, h Water, Leeds
 Bailey George, emp W. D. Clapp, bds Bates
 Bailey Thomas H., mechanic, h 37 Main, F
 Bailey William A., (Brown & Bailey,) h Allen
 Baker Elizabeth Miss, h 24 Pomeroy Terrace
 Baker Frank E., emp Nonotuck Silk Co., bds Water, Leeds
 Baker Geo. G., mason, h 80 South
 Baker Geo. N., emp F Machine Co., h Fruit, F
 Baker Henry, supervisor N. H. & N. R. R., h 47 Bridge
 Baker Horace H., boot and shoe dealer, 60 Main, h 12 Holyoke
 Baker Lyman, h Main, Bay State
 Baker William, laundryman, h Bridge c Lincoln av
 Bakeman Charles, laborer, h Water n Bridge
 Bakeman Edward, laborer, bds 34 Bridge
 Bakeman Isaac, laborer, bds N Prospect
 Bakeman Joseph, laborer, h 67 South
 Bakeman Josiah, h Lincoln av
 Bakeman Josiah, laborer, bds Water n Bridge
 Bakeman William, laborer, bds Bridge
 Bakeman see Beekman
 Baldwin Jonathan, cutler, C Mfg Co., h Main, Bay State
 Ball Justin C., painter, bds 61 South
 Ballou Alanson S., h 26 Market
 Ballou George E., overseer N Silk Co., h Bridge, F
 Banks Elizabeth, widow James, h River
 Banks Kate E., music teacher, bds River
 Banister Edwin, carpenter, h 24 Gothic
 Banister Edwin Mrs., music teacher, h 24 Gothic
 Banister Edwin H., (E. P. Hall & Co.,) h 12 North
 Banister Ida C., teacher High School, bds Prospect c Park
 Baptist Church, Main opp Elm
 Barber George W., emp Day Bros., bds South n Brick yard
 Barber Louis, peddler, bds Rust's blk, South
 Barber Thomas, painter, h Lake, F
 Bardwell Amy, widow Ralph B., h Pine, F
 Bardwell Celestia M., widow H. C., h Main, F
 Bardwell Charles L., emp at cemetery, h Bates
 Bardwell Edward, removed to Whately
 Bardwell Edwin, mechanic F Machine Co., h Chestnut, F
 Bardwell Eveline, widow Halsey, h West Farms
 Bardwell Hiram, laborer, h 21 Vernon

Bardwell H. J., rem to Boston
 Bardwell William R., color dyer Warner's Silk Mill, bds Pine, F
 Barker Stephen, h Henshaw av
 Barlow Warren W., emp E Paper Co., h Loudville.
 Barnard Abner, farmer, h West Farms
 Barnard Edward H., sup't Warner's Silk Mill, h Main opp Holyoke, F
 Barnard Myron O., attendant N L. Hospital, bds do
 Barnes A., painter, bds Florence House, F
 Barnes Edward H., rem to Springfield
 Barnes Ethan, h State opp Center
BARNES F. A. & W. E., druggists, 20 Main, F [See p 256.]
 Barnes Forest J., night watchman, h Franklin
 Barnes Frank A., (F. A. & W. E. Barnes,) h North Main, F
 Barnes John, asst. engineer Dewey House, Smith College
 Barnes Mary P., widow Willard, h 11 River
 Barnes Thomas, laborer, h r 15 State
 Barnes William E., (F. A. & W. E. Barnes), h North Main, F
 Barney Ashton, clerk, bds Smiths Ferry
 Barney Elbridge D., farmer, h Smiths Ferry
 Barr Jacob, emp B B & Co., bds 22 Walnut
 Barrett Edward S., soap manufacturer, Bates, h do
 Barrett Edward T., agt. Singer Mfg Co., 107 Main, N, h Meadow, F
 Barrett Ella L. Miss, clerk 56 Main, bds 12 South
 Barrett Etta G. Miss, dressmaker, bds 12 South
 Barrett John, bds Meadow, F
 Barrett Mary K., widow Horace J., h 12 South
 Barrus Charles, canvasser, h Fort
 Barrus Clifton L., carpenter, bds Fort
 Barry Daniel, gardener A. T. Lilly, h 16 Prospect, F
 Barry M. E. Rev., pastor St. Mary's church, h 6 Hawley
 Barry Patrick, laborer, h Winter
 Barry Patrick, laborer, h State, ab Spring
 Bartlett Alvah L., farmer, h 38 South
 Bartlett Arthur K., tailor, h West, n iron bridge
 Bartlett Ashbell S., h 15 Masonic
 Bartlett Charles S., clerk R. M. Branch, h Main cor Chestnut, F
 Bartlett Edwin P., farmer, h West Farms
 Bartlett Elijah H., h 41 South
 Bartlett Frances A. Miss, seamstress, bds West n iron bridge
 Bartlett Frederick E., farmer, h 40 South
 Bartlett George O., blacksmith emp C. L. Richardson, bds Gothic
 Bartlett Harriet, widow Edmund, h West Farms
 Bartlett Henry, rem to Whately
 Bartlett Henshaw B., farmer and saw mill, h West Farms
 Bartlett Jerome, laborer, h N Elm opp Spring
 Bartlett John, mason, h West Farms
 Bartlett Laura B. Miss, h 45 South
 Bartlett Loren S. Mrs., h West Farms
 Bartlett Luman E., farmer, bds West Farms
 Bartlett Mary A., widow Jared L., h West

Bartlett Martha H., widow Calvin L., h 65 N Maple, F
 Bartlett Mary Miss, emp L. J. Warner, bds Elm n Silk Mill
 Bartlett Munroe, bds West Farms
 Bartlett Oliver, carpenter, h West Farms
 Bartlett Osborn, farmer, h West Farms
 Bartlett Roland S., Sup't Williams Mfg Co., h Fruit
 Bartlett Theodore, farmer, h 40 South
 Bartlett Walter L., mechanic, bds 65 N Maple, F
 Bartley Michael, emp F Machine Co., h South, F
 Bartley Patrick, agent Home Sewing Machine Co., h South F,
 Barton Aaron C., h Main, Bay State
 Barton Augustus ice peddler, h r 35 Pleasant
 Barton Mary A., widow Lewis, bds Elm c Massasoit
 Bass Charles, laborer, h Bridge n Chestnut, Florence
 Bass Maria L. emp N Silk Co., bds 48 N Maple, F
 Bassett Charles, rem to Springfield
 Bassett William G., attorney at law Judge Probate Court, for Hamp-
 shire Co., Office, 74 Main, res Easthampton
 Bateman Isaac, laborer h North
 Bates John E., driver Smith Carr, h Fruit
 Bates Margaret, widow Quincy, bds Center
 Bates Richard, weaver h off Meadow, Florence
 Baurhyte Leo A., emp Telephone Co., rooms 92 Main
 Baxter John, emp Clement Mfg Co., Beacon, Florence
 Bayliss George, rem to Brooklyn, N. Y.
 Bay State Telephone Co., A. E. Cross, Manager. 92 Main
 Bazil Mondor, emp Emery Wheel Co., bds High, Leeds
 Beals Clarinda O. Miss, bds 67 N Maple, F
 Beals Frank H., contractor F Furn Co., h Main, F
 Beals George L., carpenter F Furn Co., bds Main, F
 Beals Sibyl, widow, bds 67 N Maple, F
 Bean J. W., caterer, emp Mrs. M. K. Olney, rooms 3 Clark av
 Beaman Alexander, emp W Mfg Co., h 28 Maple
 Beaudry Antoine, blacksmith, bds 32 Market
 Beaudry Joseph, night watchman F Mach Co., h 27 Center, F
 Beaulieu King, emp Z. Field, Hockanum road
 Beauregard Eusebe, carpenter, h 16 Walnut
 Beauregard Mary, widow Louis, h 20 Main, F
 Beauregard Z., brick maker, h Federal, Bay State
 Becker Peter, emp F Mfg Co., h Lilly n N Main, F
 Becket Eddie F., emp N Cutlery Co., bds Maple, Bay State
 Becket John H., bds Maple, Bay State
 Becket Thomas, laborer, h N King
 Becket Thomas, emp Landy Bros., h Maple, Bay State
 Bedard Frederick, brick maker, h Paper Mill road, Bay State
 Bedaw Joseph, emp brick yard, h Warner, Bay State
 Bedoin David, rem to Plattsburgh, N. Y.
 Beekman Charles K., laborer, h Water n Bridge
 Beekman Robert L., emp A. Kingsbury & Son, bds Water n Bridge
 Belden Caleb, broom maker, h off Bates
 Belden Charles H., emp B & A R R, bds N Elm

Belden Henry, emp Gas Co., h State n Park

BELDING BROS. & CO., silk manufacturers, 27 Hawley. [See front cover.]

Belhumeur Frank, emp N Silk Co., h Water, Leeds

Bell Edward H., (Lincoln & Bell,) h 34 Gothic

Bell Matthew, emp B Bros & Co., bds 33 Pleasant

Belleville Sifroi, carpenter N L Hospital, h Hospital Hill

Bellow William, emp Day Bros., h Easthampton road

Bement Charles A., emp T A Orcutt, bds Pine n Main, F

Bement Frederick W., book keeper, B Bros & Co., bds 10 Hawley

Bement Mary E., widow Albert A., h Pine n Main, F

Bement William, mechanic, h 70 Pleasant

Benjamin Jane, widow C. S., h 5 Hawley

Bennett Patrick Mrs., h South, F

Bennett Ripley C., tallyman Conn River Depot, h 1 Holyoke

Benoit Alexander, emp W Mfg Co., h 5 Maple

Benson John M., engineer F Mach Co., h 35 Gothic

Benway George, laborer, h Nonotuck N Main, F

Berger John, painter, h 88 South

Bergeron James, emp W Mfg Co., bds Rust's Block, South

BERNHARDT JOHN, manager, German Social Club House, Court c King, h do. [See p 284.]

Barthold Frederick, silk worker, h 18 Market

Bethune Joseph, emp F Mach Co., h 15 Chestnut, F

Bezeanson Etta Miss, emp B Bros. Co., bds Center

Bezeanson Theo Miss, emp B Bros. Co., bds Center

Bezeanson Lorinda Miss, emp B Bros. Co., bds Center

Biddle James E., photographer, emp Knowiton Bros., h 14 Wash Av.,

Bienenzucht Elisha, rem to New York

Bigelow Charles H., painter, h Spring

Bigelow Henry laborer, h West Farms

Billings Charles T., painter, emp C. H. Jones, h 76 Pleasant

Billings Harriet S Miss, bds 7 King

Billings Henry P., Register of Deeds, office County Court House, bds Mansion House

Billings Theo. S., painter, h 60 Pleasant

Billinreve Oliver, emp Non. Silk Co., h Water

Bilz Ferdinand, emp N Pocket Book Co., h King c Myrtle

Binns John T., moulder F Mach Co., h 12 Chestnut, F

Bird John W., news office books, periodicals, Main c Maple, h W Center, F

Birge Arthur, laborer, bds 49 South

Birge Simeon W., laborer, h Franklin

Birge Sultana S., widow of George A., h Hospital Hill

Birge William C., farmer, h off Bridge Road

Birsfelder J. J. weaver, emp B Bros. Co., bds State, c Bright

Bishop Alexis, carpenter, h Perkins, av

Bishop Frederick H., emp Williams Mfg Co., h 14 Olive

Bishop Joseph, teamster, h Ox Bow

Bishop Laureston H., fish peddler, h 11 Clark av

Bissell Frank W., carriage painter, emp J. C. Jager, bds Holyoke, F

- Bisailon John, emp N Cutlery Co., h Cutlery blk, Bay State
 Bisailon Joseph, emp M R Button Co., h 3 Warriar's Row, Leeds
 Bisailon Joseph Jr., rem to Montreal
 Black John C., emp W. W. Boynton, h N Main, F
 Blake Ellen Mrs., h State n Main
 Blaklely Charles, moulder, bds 30 Maple, F
 Blanchard Augustus, engineer, bds Main, Bay State
 Blanchard John A., foreman spinning dep't G Mfg Co., h 6 Nonotuck, F
 Blanchfield Alice, widow Edmund, h State
 Blanchfield Edward, laborer, h 2 Cherry
 Blanchfield James, wallet maker, h Winter
 Blanchfield Michael, watchman, h King
 Blanchfield Michael W., laborer, h 18 Cherry
 Blanchfield Thomas, cigar maker, T. J. Slattery, bds 177 Main
 Bliss Charles W., h 52 Gothic
 Bliss Esther M., widow William, h 14 South
 Bliss George P., foreman wood dep't N Silk Co., h 14 Prospect, F
 Bliss Hannah M. Mrs., attendant Shady Lawn, h do
 Bliss Mary Miss, h 52 Gothic
 Bliss Sophia E. Mrs, housekeeper N Silk Co., boarding house, Leeds
 Bliss William C., painter, emp C. H. Jones, bds Jones' blk, Court
 Bliven Ida F. Miss, bds Main c Maple, F.
 Blodgett Benjamin C., professor of music, h Prospect
 Boardway Alexander, laborer, h Ox Bow
 Bodman Luther, President Hamp Co National Bank, and President
 Trustees Smith Charities, h Elm c Round Hill road
 Bodman Samuel C., h Maple, F
 Bogas Bessimer, emp W Mfg Co., h 8 Market
 Bolan John, emp B Bros & Co., bds Nonotuck House
 Bolter Charles J., emp Searle & Edwards, bds 89 South
 Bolter Edward, emp N Silk Co., bds Water, Leeds
 Bolter Samuel L., station and express agt., h Grove av., Leeds
 Bolter William T., machinist, h state ab Spring
 Bond Daniel W., dist attorney and attorney-at law, Jones' blk, Court
 h 13 Main, F
 Bond Elizabeth P., widow Henry H., h 32 Pine, F
 Bond Elizabeth S. Miss, h 32 Pine, F
 Bond George W., agt Florence Tack Co., h 46 Main, F
 Bond Mary W. Miss, Sec'y and Treas Florence Savings Bank, h 32
 Pine, F
 Borden A., bds Lilly n North Main, F
 Bosworth Edward C., farmer, West Farms
 Bosworth Harvey, laborer, h Bridge
 Bosworth Herbert S., teamster, bds 12 N Main, F
 Bosworth Luther H., dyer N Silk Co., h Lilly n Meadow, F
 Bosworth Mary Miss, emp L. J. Warner, bds Elm n Silk Mill
 Bosworth Sylvester J., farmer, h 12 N Main, F
 Botsford Agnes Miss, bds 21 Pleasant
 Botsford Lena Mrs., h 21 Pleasant
 Bottum Edward S., traveling agt F Tack Co., h 32 Main, F
 Bottum John B., attorney-at-law, 112 Main, N., bds 32 Main, F

Bottum Samuel A., farmer, h 32 Main, F
 Boucher John, laborer, h 87 South
 Boucher Lewis, emp W Mfg Co., bds South
 Boutelle Don F., attendaut Shady Lawn, Gothic, bds do
 Bouvet Francis, emp B Bros & Co., h 24 Market
 Bouvet Leonard, emp B Bros & Co., h 24 Market
 Bouvia Charles, teamster M R Button Co., h Main, Leeds
 Bowles Arthur, emp W Mfg Co., bds 14 Olive
 Bowman Frederick H., clerk G. L. Loomis & Co., h Franklin
 Boyd George S., teamster Kimball & Cary, h North
 Boyden Charles H., foreman Crystal Emery Wheel Co., h Lincoln av
 Boyer Louis, emp W Mfg Co., h 8 Market
 Boyle John teamster Landy Bros., bds 30 Maple, F
 Boynton Frank B., tin peddler, h N Main, F
 Boynton George F., painter, N Maple, F, h do
 Boynton Sarah Mrs., bds North c Pine
 Boynton Wallace W., soda and mineral water manf, River, h 37 Prospect
 Brackett Alice M. Mrs., fancy goods and millinery, 8 Center, F, h do
 Brackett Ezra M., machinist, h Center, F
 Bradford Ansel K., truckman, h 23 N Main, F
 Bradford Henry C., clerk E. A. Brooks, h Walnut c Pine
 Bradford Herbert L., emp Crystal Emery Wheel Co., h 8 Walnut
 Bradford Ida C. Miss, clerk 50 Main, bds 9 Franklin
 Bradford Lizzie J. Miss, book keeper Lincoln & Bell, bds 9 Franklin
 Bradford Sarah J., widow William R., h 9 Franklin
 Brainard Edward A., florist, Elm c Vernon, h do
 Brainard James F., clerk L. J. Warner, h N Main, F
 Brady Patrick, emp Wire Mill, bds 11 State
 Brady Susan Miss, housekeeper Rev. P. F. Callery, Beacon, F, h do
 Brady William J., foreman doubling dep't B Bros & Co., h 13 Holyoke
 Braman Charles H., laborer, h Hospital Hill
 Braman Curtis W., stone mason, h West
 Braman Edward C., lather, h Hospital Hill
 Braman Elias G., h Hospital Hill
 Braman George A., carpenter, h Hospital Hill
 Braman George W., emp N Ice Co., h Pine Grove
 Braman Whitney W., stone mason, h Hospital Hill
 Branch Robert M., grocer, dry goods, crockery, boots, shoes, &c.,
 Main, h Meadow, F
 Brandle Jacob Mrs., h Myrtle
 Bray Eliphalet, Chestnut ab High
 Breault John, joiner, h State n R R track
 Brebner Hannah, widow George, h Arlington
 Breck Ruth Miss, rem to Springfield
 Brennan Lewis, emp E. N. Foote & Co., bds r 24 Hawley
 Brennan Owen, laborer, h Paper Mill road
 Bresby L. B., farmer, h North Farms
 Bresnahan Thomas, laborer, h Nonotuck c Water, F
 Breslin Thomas, bds North n Lincoln av
 Brewer Edwin B., (Clapp & Brewer), h 56 N Maple, F
 Brewer Hannah E. and Fanny Misses, h 38 Elm

- Brewster Charles H., florist, South n Main, h do
 Brewster Clara A., widow Jonathan, h 43 Elm
 Brewster Henry N., plumber, bds N Main, F
 Brewster William W., butcher Clapp & Johnson, h slaughter house road
 Brick James, mechanic, h Haydenville road, Leeds
 Brick John, laborer, h Mill Yard
 Brick Patrick, laborer, h Mill Yard
 Bride John, emp M R B Co., h Water, Leeds
 Bridgman Abner P., farmer, h Park c W Center, F
 Bridgman A. C., (S. E. Bridgman & Co.), bds 31 Elm
 Bridgman Alson R., blacksmith emp L. I. Clark, bds 27 Maple, F
 Bridgman A. M., (Bridgman & Gay), h 10 Phillips Place
 Bridgman Betsey C., widow Sylvester, bds 31 Elm
 Bridgman Charles J., machinist emp W Herrick, h 53 Elm
 Bridgman Edward, policeman, h Center av opp Masonic
 Bridgman Howard A., teacher, bds 31 Elm
 Bridgman Oliver C., locksmith, 52 Main, h 6 Clark av
 Bridgman Oscar, teamster, rooms 41 Center
 Bridgman Robert L., rem to Belchertown
 Bridgman Sarah M., widow Thomas, h 53 Elm
 Bridgman Sidney E., (S. E. Bridgman & Co.), h 31 Elm
BRIDGMAN S. E. & CO., (Sidney E. Bridgman, A. C. Bridgman), booksellers, stationers and publishers, 76 Main. [See opp inside back cover.]
 Bridgman Thomas, bookbinder, emp Henry Childs, h 53 Elm
 Bridgman Victor H., law student with J. C. Hammond, res Amherst
BRIDGMAN & GAY, (Arthur M. Bridgman, Moses S. Gay), publishers Hampshire Daily and Weekly Herald, Jones' blk, Court
 Briggs Horace A., farmer, h Prospect
 Briggs Lyman H., farmer, h Smiths Ferry
 Briggs, emp M R B Co., bds Water, Leeds
 Briggs S. A. Miss, emp Nonotuck Pocket Book Co., bds 72 Myrtle
 Brigham F. E. Miss, bds High, F
 Brigham Samuel T., clerk restaurant C R R R depot, bds High, F
 Brisbois Louis, laborer, h Grove av, Leeds
 Briscole George D., teamster, h 53 Pleasant
 Bristol Frank, carpenter, h Meadow c Lilly, F
 Britt Alice A., emp 46 Main, F
 Britt Edmund, laborer, h 92 Elm n N Elm
 Britton Catherine Miss, h South, F
 Britton Nicholas, laborer, h South, F
 Broadhurst William Mrs., housekeeper, 17 Union
 Brochu Gideon, emp M R B Co., h Water, Leeds
 Brock Alex, laborer, h Pleasant
 Brockway William Mrs., h 18 Franklin
 Bronson Merton A., laborer, h Market
 Brooks Alpheus, 77 Elm, bds 20 Franklin
BROOKS EDWARD A., grocer, 14 Main, h 7 Strong av. [See p 260.]
 Brooks James, laborer, h Mill, Bay State

- Brooks Levi, laborer, h Fort
 Brooks Mary Miss, bds 36 Market
 Brooks Nathan, laborer, h South, F
 Brooks Nathan, laborer, h Pine Grove
 Brooks Nathan B., laborer, h Hospital Hill
 Brooks Rufus, rem to Springfield
 Brooks Samuel, farmer, h Hospital Hill
 Brot Peter, emp Z. Field h Hockanum road
 Brothers Charles, laborer, h 12 Pleasant
 Brown Albert G., machinist, rem to Brattleboro, Vt
 Brown Ann, widow Elbridge G., bds 9 Center, F
 Brown Champion M., farmer, h High, F
 Brown Charles T., agt fertilizers and salt, Main c Hawley, h 62 Elm
 Brown Charles J., foreman N Silk Co., h Lilly n N Main, F
BROWN CLARENCE E., silver and nickel plater, 41 Center, h
 do. [See p 240.]
 Brown Ernest, h South, F
 Brown Flora R., attendant N. L. Hospital
 Brown Francis E., carpenter, h 14 Summer
 Brown George H., farmer, h 7 Lincoln av
 Brown Herbert W., traveling salesman, h 30 Center
 Brown Jere (Brown & Bailey), h 41 Gothic
 Brown John, emp Norwood Ice Co., bds 11 State
 Brown John F., mechanic F Mach Co., bds 52 Main, F
 Brown Lizzie Mrs., h 19 Chestnut, F
 Brown Lyman, shoe maker, Main, Bay State, h do
 Brown Michael, teamster W Mfg Co., h Olive
 Brown Minnie Miss, bds Masonic
BROWN RODNEY, prop'r Mansion House, 129 Main. [See p 277.]
BROWN RUFUS D., dentist, Davis blk, Main, F., h Center, F
 [See p 244.]
 Brown William E., carpenter, h 14 Market
 Brown William H., clerk, rem to Toledo
BROWN & BAILEY, (Jere Brown, William A. Bailey), masons
 and builders, Gothic c Clark. [See p 271.]
 Bruce Maria E. Miss, bds 3 Market
 Bruce Mary S. Mrs., h 3 Market
 Brunnell Frank X., barber Easthampton, h 106 State
 Bryant Allen, blacksmith, Maple n railroad crossing, h 19 High, F
 Bryant Eleazer, mechanic F Mach Co., h 36 Main, F
 Bryant Joseph, h Maple n Pine, F
 Bryant Luther P., printer, Main, F, bds do
 Buckbee Lucy, widow Jerome, h 12 South
 Buckley James C., bookkeeper, rem to Chicopee
 Buckley John, teamster, h 17 High, F
 Bucknam Dwight, carpenter, h 44 Market
BUCKNAM HENRY S., truckman and piano mover, office 124
 Main, Opera House Block, h 18 Cherry. [See p 274.]
 Bucknam James E. Mrs., h 19 Cherry
 Bucknam William H., farmer, bds 19 Cherry

Buehrnes Charles, emp Nonotuck Pocket Book Co., bds 24 Hawley
 Bugg Thomas, Metropolitan Ins Co., h River
 Burby Napoleon, rem to Rutland, Vt
 Burby James D. (Hayes & Burby), h Holyoke, Mass
 Burkhard Daniel, emp F Machine Co., h Holyoke, F
 Burdick Jennie L., paper box maker, bds 17 High, F
 Burgess Joseph, emp B Bros & Co., bds Holyoke c Williams
 Burke James, emp N Cutlery Co., bds Union, Bay State
 Burke John, emp N Silk Co., bds Leonard, Leeds
 Burke Margaret, widow John, h N King
 Burke Michael, emp Landy Bros., h South, F
 Burke Michael, laborer, h Hickory, F
 Burke Patrick, farmer, h Pine Grove
 Burke William, laborer, h Nonotuck, F
 Burket James, emp N Silk Co., h Bridge, F
 Burleigh Kate Mrs., music teacher, h Park, F
 Burleigh Le Moyne, h 18 Park, F
 Burnett Maria L. Mrs., waiter, Shady Lawn
 Burnham George, emp F Mach Co., bds 56 N Maple, F
 Burnham Mary A. Miss, young ladies' classical school, 17 Elm
 Burns Ann Mrs., cook Florence House, F, bds do
 Burns Dennis, rem to Enfield, Mass
 Burns John, emp E. Paper Co., bds Loudville
 Burns Patrick, cutler N Cutlery Co., h Maple, Bay State
 Burns Thomas F., emp C Emery Wheel Co., bds King
 Burns Thomas, h 84 Market
 Burr Sarah M., widow George A., h Beacon n Pine, F
 Burrows James P., emp Bay State Co., h Holyoke, F
 Burrway George, brush maker, h Nonotuck, F
 Burt Charles R., travelling agent, h West Farms
 Burt Nancy, widow Enoch, h 17 Center, F
 Burt Sarah Miss, h Union c Pine
 Burtch E. Agnes, teacher, bds Park, F
 Burton Louis E., rem to Norwich, Vt
 Burton Sophronia, widow John D., bds 17 N Main, F
 Busch Henry, laborer, h N Elm
 Bush Charles R., carpenter, h Elm, n brick yard
 Bush Henry, laborer, h Hospital Hill
 Butcher Joseph, emp C Mfg Co., bds Hinckley, Bay State
 Butler Arthur, rem to Philadelphia
 Butler George, bds 4 Hawley
 Butler Sarah, widow J. H., h 4 Hawley

CAHILL JOHN, emp E Paper Co., h Loudville
 Cahill John, h Warner, Bay State
 Cahill John T., spinner N Silk Co., h Water, F
 Cahill Michael, emp J. D. Norton & Son, h Loudville
 Cahill Patrick, rem to Michigan
 Cahill Thomas, farmer, h Loudville
 Caldwell Hugh, tailor, h King

Callahan Michael, laborer, h Kirkland av
 Callahan Thomas, emp E. H. R. Lyman, bds Pleasant
 Callery P. F. Rev., pastor church of the Immaculate Conception, h
 Beacon, F
 Callery Rose A., housekeeper R. C. parsonage, Beacon, Florence
 Campbell Addie C., emp N Silk Co., bds N Main, F
 Campbell Florence R. Miss, bds N Main, F
 Campbell Frank, laborer, h Kirkland av
 Campbell Fred E., painter F Furn Co., h N Main, F
 Campbell George, laborer, h 32 South
 Campbell George L., clerk R. M. Branch, h N Main F
 Campbell George P., gardener, h 8 Hawley
 Campbell Herbert S., clerk 30 Main, bds 11 River
 Campbell John L., book keeper B Bros & Co., bds 8 Hawley
 Campbell Levi N., h N Main n Myrtle, F
 Campbell Louis L., postal clerk, bds N Main, F
 Campbell William L., emp E. N. Foote, h 81 South
 Cantwell Thomas, mechanic N Cutlery Co., h Main, Bay State
 Capen B. T. Miss, associate principal, young ladies' classical school,
 h Prospect
 Carabine Patrick, emp W Mfg Co., h Williams c Front
 Cardinal John B., clerk E. S. Ross, h Water, Leeds
 Carey Catharine, widow John, h West n R R
 Carey Edward, h Mill, Bay State
CARLEY ALFRED G., news dealer and stationer, 115 Main, h
 Myrtle. [See p 255.]
 Carlisle Charles B., traveling salesman W Mfg Co., h 13 Phillips Place
 Carnall Joseph, cutler N. Cutlery Co., h Main, Bay State
 Carney Patrick, emp M R B Co., h Water, Leeds
 Carpenter David, clerk E. S. Ross, h Water, Leeds
 Carpenter David, Jr, sawyer N Silk Co., bds Water, Leeds
 Carpenter Francis, laborer, h Main, Leeds
 Carpenter Leon, emp Button Co., bds Water, Leeds
 Carpenter Peter, emp W Mfg Co., h State n R R track
 Carr Smith, cracker baker, 157 Main, h 155 do
 Carroll Bridget, widow William, h Hinckley, Bay State
 Carroll James, saloon Hinckley, Bay State, h do
 Carroll James Mrs., rem to Holyoke
 Carroll Matthew, grocer and steamship agent, 1 Masonic, h do
 Carroll Michael T., clerk Matthew Carroll, h 27 Williams
 Carroll M. J. Rev., asst. St Mary's Church, h 6 Hawley
 Carroll Thomas J., emp N Cutlery Co., bds Hinckley, Bay State
 Carson Andrew, emp B Bros & Co., h 8 Holyoke
 Carson Fred, farmer, Coles Meadow
 Carson John emp B Bros & Co., h 4 Valley
 Carson Lewis, farmer, bds Elm n Silk Mill
 Carson William, emp B Bros & Co., h 40 Williams
 Carter William, cutler N Cutlery Co., h Main c Norwood av, Bay State
 Carter William H., emp N Cutlery Co., h Main c Norwood av, Bay State
 Cartwright Thomas J., emp N Cutlery Co., bds Arlington
 Carver Freeman C., steward Clarke Institution, h 23 Massasoit

- Cary Edward, h Mill, Bay State
 Cary Frank W., (Kimball & Cary, h 47 Gothic
 Cary Lucy J. Miss, cook Shady Lawn
 Casey John, laborer, h Mill Yard
 Casey Michael, laborer, h Bates
 Cashman Cornelius, laborer, h River c Maple, F
 Cavanaugh Bridget, h West, F
 Cavanaugh Patrick, teamster M. L. & M. W. Graves, h 4 School
 Central Hall, Kirkland's blk, 52 Main
 Chabot Abel A., clerk 68 Main, bds 1 School
 Chabot Herbert H., clerk 80 Main, bds 1 School
 Chabot Jude, emp Star Printing Co., h 1 School
 Chabot Julius, peddler, Lyman & Shipman, h 13 High
 Chamberlin Albert (Watson & Chamberlin), h Easthampton
 Chandler Ann, widow Pomeroy, h Coles Meadow
 Chandler Anna Mrs, h Coles Meadow
 Chandler P. John, farmer, h Coles Meadow
 Chandler Margaret, widow John, h Coles Meadow
 Chandler John, farmer, h Coles Meadow
 Chandler Michael, farmer, h Coles Meadow
 Chapel Henry, silk weaver, bds 58 Bridge
 Chapin George, h Masonic
 Chapin Martin C. Rev., h 22 N Main, F
 Chapintier, Peter, baker, emp 10 Market
 Chapman H. S., prop'r Northampton, Florence, Leeds, Haydenville
 and Williamsburg stage line, res Williamsburg, office 100 Main
 Charland Joseph J., rem to Three Rivers
 Charpentier Adolph Mrs., h 12 Main
 Charron Joseph, rem to Canada
 Chase Aquilla W., rem to Orange, Mass
 Chase Bros., managers Northampton Opera House, res Holyoke
 Chase Elijah (E. Chase & Son), h Maple, F
 Chase Elijah Jr., mason, h 9 Arlington
 Chase Elijah & Son, (Elijah and Frederick E.), masons, Maple n
 Pine, F
 Chase Frederick E. (E. Chase & Son), h N Main, F
 Chase George B., mason, bds Maple, F
 Chatel Edmund, rem to Manchester, N. H.
 Checcinio A., emp B Bros & Co., h 3 Valley
 Cheeseman Charles, rem to Holyoke
 Cheeseman Clayton H., canvasser, bds 61 South
 Cheeseman U. Frank, laborer, h 61 South
 Chevalier Charles, emp N Silk Co., bds Water, Leeds
 Chevalier Francis, emp Button Co., h Water, Leeds
 Chickering Henry E., emp F Mach Co., h 13 Chestnut, F
 Childs Charles E., book-keeper G Mfg Co., bds Pine, F
CHILDS HENRY, book bindery, blank book mfr, 74 Main, h
 Henshaw av. [See inside back cover.]
 Childs Laura A., Miss, h 32 South
 Childs M. D. Mrs., dressmaker 58 Main, h Henshaw av
 Childs William P., clerk M. M. French & Co., 82 Main, rooms 23
 Pleasant

- Chilson Haynes H., attorney-at-law, First Nat'l Bank Building, h 15
 Washington av
 Chilson Henshaw B., rem to New York
 Chilson H. H. Jr., law student, bds 15 Washington av
 Christie Gilbert A., bds 5 Phillips Place
 Church Charles H., emp C Emery Wheel Co., h Bank av n King
 Church Frank, farmer N. L. Hospital, bds do
 Church Herbert E., hostler E. T. Wood Jr., bds Pearl
 Church Martha A. Mrs., bds 3 Phillips Place
 Church Ozro, h Bridge opp Lincoln av
 Claghorn A. M., clerk, h Washington av
 Claghorn J. Fred., book-keeper J. M. Towne & Sons, h 38 Wash. av
 Clair John, emp M R Button Co., h Main, Leeds
 Clair Matthew, sexton Catholic Cemetery, h Bridge road
 Clancy Catharine, widow John, h Massasoit
 Clancy Daniel, emp N Cutlery Co., bds Main n Spring, Leeds
 Clancy John, rem to Springfield
 Clancy John N., emp M R Button Co., h Main n Spring, Leeds
 Clancy William, laborer, h 52 South
 Clapp Angeline, widow Edward, h Roberts Meadow
 Clapp Anson M., (Clapp & Brewer), h Fruit n Main, F
 Clapp Charles C., farmer, h Main, Bay State
C LAPP CHARLES E., machinist and iron founder, Pleasant c
 Holyoke (and Chas. E. Clapp & Co.), h 10 Union [See p 239.]
 Clapp Charles E. & Co., (Charles E. Clapp, Robert H. Mehl), button
 mfrs, Pleasant c Holyoke
 Clapp Charles R., clerk 112 Main, bds Bay State
 Clapp Clark D., peddler, h 12 Prospect, F
 Clapp Dorcas E., Mrs., h Washington av
 Clapp Lydia, widow Munroe, h 46 South
 Clapp E. C. & Bro. (Martin L., Edwin C.), farmers and horse dealers
 66 South
 Clapp Edward, farmer, h 59 South
 Clapp Edward Jr., bds 59 South
 Clapp Edwin C., (E. C. Clapp & Bro.), h 66 South
 Clapp Egbert I., dry goods, 10 Main, bds 43 King
 Clapp Elizabeth D., widow Azariah, h 50 South
 Clapp Franklin C., emp W. C. Pomeroy, h Bates n Lincoln av
 Clapp Frank Lucius emp Clapp & Johnson h Fort
 Clapp Frank L., machinist, emp F Mach Co bds 3 Pomeroy Terrace
 Clapp George C., messenger, h Washington av
 Clapp George W., carpenter H. W. Clapp, h Fort
 Clapp Henry, h Roberts Meadow
 Clapp Henry, farmer, h Easthampton road
 Clapp Henry M., farmer, bds Roberts Meadow
 Clapp Henry W., lumber dealer and saw mill off South, h 78 South
 Clapp Hophui, h 68 Pleasant
 Clapp James, emp Pomeroy Terrace, bds do
 Clapp James, farmer, h Roberts Meadow
 Clapp John C., emp F Mach Co., h Fruit F
 Clapp Martha, widow Aaron, h 70 South

- Clapp Martha, widow Jonas, h 84 South
 Clapp Martin L., (Clapp & Johnson), h 68 South
 Clapp Mary H., widow Elijah D., h 70 South
 Clapp Merrick H., farmer, h 73 South
 Clapp, Sophia D., Miss, bds 59 South
 Clapp Theodore, farmer, h 47 South
CLAPP WILLIAM D., coal and wood dealer, Strong av n C R
 R depot, h 9 Holyoke. [See p 265.]
 Clapp William H., clerk of courts, Court House, bds Pleasant opp
 Holyoke
 Clapp William R., moulder, h Pleasant opp Holyoke
 Clapp Willis W., flour dealer, h 5 Union
 Clapp & Brewer, (A. M. Clapp, E. B. Brewer), carpenters and build-
 ers, N Maple F
 Clapp & Johnson, (Martin L. Clapp, Lowell M. Johnson), meat mar-
 ket, 109 Main
 Clare Matthew C., laborer, Bridge road n Cemetery
 Clark Alfred H., student, bds 7 Phillips Place
 Clark Alice B., Miss, music teacher, bds Clark av
 Clark Angeline, widow Walter, h West Farms
 Clark Annie M., widow William, h 47 Elm
 Clark Arthur B., clerk P. O., bds Williams n Hancock
 Clark Arthur N., rem to New York
 Clark Benjamin S., carpenter, h 2 School
 Clark Bridget, widow Francis, h 23 North
 Clark Calvin L., farmer, h 23 Bridge
 Clark Charles, farmer, h 65 South
 Clark Charles E., farmer, bds West, Leeds
CLARK CHARLES N., lawyer, 101 Main, bds 65 South. [See
 p 243
 Clark Charlotte, widow Charles E., bds 55 South
 Clarke Christopher, insurance agent, h 3 Hawley
 Clark Daniel R., h 59 Elm
 Clark David W., h 60 Elm
 Clark Delia Miss, bds 15 Maple
CLARK EDSON P., manager Clark Indelible Pencil Co., 6 Strong
 av, h 56 Bridge. [See p 246.]
 Clark Edward L., farmer, h West, Leeds
 Clark Edward P., millwright N Cutlery Co., h 16 Vernon
 Clark Edward W., clerk G. L. Loomis & Co., bds 16 Vernon
 Clark Edwin C., sup't Northampton Street Railway, h 4 Strong av
 Clark Edwin C., Jr., emp N S Railway, h 5 Strong av
 Clark Edwin W., farmer, h 88 Bridge
 Clark Ellen, widow Charles S., h 8 Strong av
 Clark Ellen H., widow Francis, cook N L Hospital bds do
 Clark Ellen S. Mrs., h Maple, F
 Clark Elvira Miss, bds 2 Fruit
 Clark Estus G., (G. L. Loomis & Co.), h Williams n Hancock
 Clark Ezra E., mach, bds 3 Hancock
 Clark Filbert O., emp E. N. Foote & Co., bds 39 South
 Clark Frank E., clerk W Mfg Co., bds South opp School

- Clark Fred., emp Nonotuck Pocket Book Co., bds Mansion House
 Clark George D., (Clark & Parsons), h 32 Maple
 Clark George E., shipping clerk, bds 34 Vernon
 Clark George H., paper maker, h 34 Vernon
 Clark George W., Smith Charities bds 58 Elm
 Clark George Wright, clerk Hamp County Nat'l Bank, bds 9 Main, F
 Clark Hannah L., widow J. L., bds 13 Phillips Place
 Clark Harriet, widow Elihu, h 58 Elm
 Clark Helen M. Miss, dressmaker, bds 8 Maple
 Clark Helen T. Mrs., h Maple, F
 Clark Henry G., farmer, bds North n Lincoln av
C **CLARK INDELIBLE PENCIL CO.**, 6 Strong av. [See p 246.]
 Clark Ida, emp N L Hospital
 Clarke Institution for Deaf Mutes, Round Hill
 Clark Isabella G., and Hattie M., private school 58 Elm, bds do
 Clark Isaac Rev., pastor Edwards Church, h 7 Phillips Place
 Clark Isaac R., painter, paints, oils, doors, sash, &c., 3 Court c King,
 h 46 Bridge
 Clark James C., hostler, bds Union
 Clark James L., hostler, rooms 167 Main
 Clark James W., farmer, h 72 Bridge
 Clark Jared, h 55 Elm
 Clark John, brick layer, h 37 Vernon
 Clark John, emp Clement Mfg. Co., h Main, Bay State
 Clark John B., Prof. History and Political Science, Smith College, h
 Round Hill
 Clark John H., driver N Beef Co., h 16 Market
 Clark Jonas M., supt N water works, office Town Hall, h 3 Hancock
 Clark Joseph H., mechanic, h N Elm opp Spring
 Clark Josiah Mrs., h 3 Main
 Clarke Julia C. Miss, assist clerk Court House, bds 57 Pleasant
 Clark, Julia S., widow Lucius h Paradise road
 Clark Levi I., blacksmith, 17 Center, h do
 Clark Lizzie H. Miss, teacher, bds 34 Vernon
 Clark Lizzie & Mary K., props Kindergarten school, 120 Main, rooms
 Mrs. E. Turner's West
 Clarke Lucinda B., widow Frederick, h 59 Pleasant
 Clark Louis H., medical student with Dr. Thayer, bds 14 Vernon
 Clark Luman S., farmer, h 91 Bridge
 Clark Luther A., clerk E. A. Brooks h 3 Pomeroy Terrace
 Clark Luther H., carpenter, h 14 Vernon
 Clark Lydia A., widow Joseph C., prop Union Coal Yard, 39 Pleas-
 ant, h 43 Pleasant
 Clark Mary K., teacher, bds West
 Clark Merritt, (Merritt Clark & Co.), h Round Hill c Elm
 Clark Merritt & Co., (Merritt and Orman S. Clark), clothiers and
 merchant tailors, 110 Main
 Clark Nancy W., widow Moses D., h 29 Bridge
 Clark Nathaniel, farmer, h 103 South
 Clark Nellie, widow Francis, emp N L Hospital, bds do

Clark Orman S., (Merritt Clark & Co.), h 6 Fruit
 Clark P. K. rem Mt. Carmel, Ct.
 Clark Robert L., emp W. Herrick, bds 55 Gothic
 Clark Sarah A., widow Newman, h 43 Elm
 Clark Sarah M., widow Anson B., h 9 Main, Florence
 Clark Sereno, nurse, h 103 South
 Clark Sidney L., gen manager F Mach Co., bds 9 Main, Florence
 Clark Silas D., h Clark av
 Clark Solomon W., farmer, h 92 Bridge
 Clark Sumner S., emp L. W. Smith, h 56 Bridge
 Clark Susan E. Miss, h 8 Maple
 Clark S. William, farmer, bds 92 Bridge
 Clark Tamison Miss, rem to So Deerfield
 Clark Ursula Miss, h Water n Bridge
 Clark Warren P., h 39 South
 Clark William, painter, bds Florence House, Florence
 Clark William G., emp Florence Mach Co., h Holyoke, Florence
 Clark William H., farmer, h 37 Bridge
 Clark William S., car worker, bds 2 School
C **CLARK & PARSONS**, (George D. Clark, Lewis D. Parsons),
 druggist and chemists, 125 Main. [See inside front cover.]
 Classical school for girls, Misses Burnham and Capen, Prospect and Elm
 Clatterbrook Thomas, emp Geo. G. Baker
 Cleary Michael, stone mason, h N Elm
 Clevez Charles A., bds River, Bay State
 Clevez Joseph A., bds River, Bay State
 Clevez Emil, blacksmith, Clement Mfg Co., h Bay State
 Clement Charlotte, widow William T., bds 9 Elm
 Clement John, mason, rem to Holyoke
 Clement Mfg. Co., cutlery manufacturers, Union, Bay State
 Clement Nathan S., machinist, shop at F Mach Co., h High Florence
 Clemons Joseph R., emp Williams Mfg Co., h 12 Clark av
 Clemons Julius E., foreman Williams Mfg Co., h 41 Prospect
 Cleveland Vernett E., bookkeeper S. Carr, h 2 Maple
 Closson Charles, driver C. A. Maynard, h 14 Franklin
 Closson William, baker Smith Carr, h 24 State
 Cloud Mary, rooms 43 King
 Clough M. J. Mrs., h 13 Washington av
 Cluffe John, emp B Bros & Co., bds 2 Valley
 Cluffe William, emp B Bros & Co., bds 2 Valley
 Cluffe William, emp B Bros & Co., h 2 Valley
 Coady Edward, emp N Cutlery Co., bds Maple, Bay State
 Coakley James, bill poster, Opera House, res Holyoke, Mass
 Coburn John, rem to Hartford
 Coburn William A., Geo. H. Walker & Co., bds 12 River
 Cobb Elisha G., pastor Florence Cong Church, h 19 Pine, Florence
 Cobb Jonathan F., joiner, h Main, Florence
 Cobine Robert H., rem to Springfield
 Cochran Mary Miss, h 31 Bridge
 Cochran William, overseer weaving dept Damon Narrow Fabric Co.,
 h Massasoit

Coderre Charles H., clerk P. Nadeau, bds Water, Leeds
 Coffee James, laborer, h off King n Mill Yard
 Coffee John, emp N Cutlery Co., h High, Bay State
 Coffee Timothy, mason, h Hinckley, Bay State
 Coffee William, cutler, rem to Whately
 Coghlan Daniel, laborer, bds West, Florence
 Coghlan Lawrence, laborer, h West, Florence
 Coghlan Mary, widow John, h West, Florence
 Coggswell C. C., station agent and post master, Smiths Ferry, h do
 Cohn Simon, clothier 44 Main, h 7 Masonic
 Cole Edward F., carpenter, bds 11 River
 Cole Elmer, brushmaker, rem to Brightwood
 Cole Richard, farmer, h off South, Florence
 Cole Walter, coachman Dr. S. A. Fisk, h King
 Cole William, machinist B Bros & Co., bds 23 Hawley
 Coleman Albe W., carpenter, h 13 Maple, Florence
 Coleman Albert W., emp M R B Co., h Main, Leeds
 Coleman Charles, apprentice W Herrick, bds Florence
 Coleman Edward E., emp M R B Co., h Main, Leeds
 Coleman Lizzie, widow John, h Smith
 Coleman Walter H., telegraph operator, h W Center, Florence
 Coles Hattie B., widow Lewis B., h 38 Maple
 Colgau Thomas, boot maker, Nonotuck, Florence, h River, Bay State
 Colgrove Myron T. teamster, bds 53 Pleasant
 Collett John, helper R. B. Davis & Co., bds 9 South
 Collins Horace A., farmer, h Smiths Ferry
 Collins Jonathan E., farmer, bds Smiths Ferry
 Collins Michael, emp F Mach Co., bds Park, Florence
 Collins Norris D., junk dealer, h N Elm
 Collins Patrick, emp Brush Shop, bds Park, Florence
 Collins William, cutler N Cutlery Co., h Warner, Bay State
 Colson Frank A., silk worker, bds 60 Pleasant
 Colson George W., bds Nonotuck House
 Colson William B., baker, h 60 Pleasant
 Colton Fred., silk dyer, h Oak, Florence
 Colwell Hugh, tailor, emp Smith & Prindle, h King
 Cone William, carpenter, h 21 N Main, Florence

CONNECTICUT RIVER LUMBER CO., Mt. Tom. [See p 241]

Connecticut River R R Depot, Strong av
 Connell Frank, emp F Tack Co., h South, Florence
 Connell Thomas, bds Nonotuck, Florence
 Connelly Edward, emp Watson & Chamberlin Paper Co., h Loudville
 Connelly Edward, laborer, bds Loudville
 Connelly Frederick W., rem to Boston
 Connelly Joel A., clerk First Nat'l Bank, bds 17 King
 Connelly John, emp E Paper Co., bds Loudville
 Connelly Stephen, carpenter, Gothic n Court, h off King n Mill Yard
 Connelly William, farmer, h King
 Connelly William, clerk Wm. McCandless, bds 17 Gothic
 Conner Maggie Mrs., h South, Florence

- Conner William, emp N Paper Co., h Vernon, Bay State
 Conner see Connor and O'Connor
 Connors James, laborer, h Prospect
 Connors Michael, emp N Silk Co., h 29 Center, Florence
 Connors Thomas, clerk E. E. Hart, rooms Hinckley, Bay State
 Connery Ann, widow James, h 17 State
 Connery Nellie, emp N Silk Co., bds 8 Prospect, Florence
 Connery Patrick, joiner, bds 167 Main
 Connor Bridget Mrs., h South, Florence
 Connors Edward, attendant N L Hospital, bds do
 Connors Jeremiah, emp N R R, h Mill Yard
 Connors Julia, widow Dennis, h King
 Connors Michael, emp B Bros & Co., bds 42 Williams
 Connors Patrick, emp N Silk Co., bds Main, Leeds
 Conroy James S., engineer Damon Narrow Fabric Co., h 12 Park
 Constable William A., emp B Bros & Co., h 4 Union
 Constantine Mark, laborer, bds 10 South
 Constantine Tillis, laborer, bds 10 South
 Converse James, h State ab Myrtle
 Converse William T., farmer, h North n Lincoln av
 Coogan John, brass finisher, h Water, Leeds
 Coogan Michael, emp M.R Button Co., h Florence c Critchlow, Leeds
 Cook Annette S., widow Horace, h 9 Lincoln av
 Cook Benjamin E.. (B. E. Cook & Son), 19 Bridge
 Cook Benjamin E. Jr., (B. E. Cook & Son), h 8 Phillips Place
 Cook B. E. & Son, (Benj. E. Cook, Benj. E. Cook, Jr.) jewelers 80
 Main
 Cook Edwin D., emp W. F. Prindle, h Lincoln av
 Cook Eliza H., widow James S., h 53 Elm
 Cook Francis M., farmer and stone mason, h Massasoit
 Cook Fred M., teamster, bds Massasoit
 Cook George A., emp F Mach Co., h Oak, Florence
 Cook Henry P., farmer, h Lincoln av
 Cook Lavina Miss, 70 King
 Cook Samantha Miss, h r 5 Strong av
 Cook Spencer, gardener, bds 14 South
 Cook Watson A., mechanic, h 13 Center, Florence
 Cooley Esther, widow Simon, bds High
 Cooley Silas R., (Graves & Cooley,) h High
 Cooley T. C., rem to Springfield
 Coon E. Brownell, supt M R Button Co., bds Chestnut c High, Leeds
 Coonan Mary Miss, cook Mansion House
 Cooney Ella Miss, (Cooney & Larkin), bds 20 King
 Cooney John, emp G Mfg Co., h West Florence
 Cooney Michael, proprietor Florence House, Main c Maple, Florence
 Cooney Peter, laborer, bds West, Florence
 Cooney William E., clerk John Parnell, h 20 King
 Cooney & Larkin, (Miss Ella Cooney, Miss Rose Larkin), milliners,
 107 Main
 Cooper Charles W., physician 78 Main, h 41 King
 Cooper William, painter, h Maple Florence

- COPELAND EDWARD P.**, sewing machines and fancy dry goods,
72 Main, h 34 South. [See p 252.]
- Corbett Daniel, cutler N Cutlery Co., bds South, Florence
- Corbin Esther Mrs., h 84 South
- Corbitt John, laborer, h Nonotuck, Florence
- Corbitt Michael, laborer, h Haydenville road, Leeds
- Cordery Charlotte, widow John, h Fruit
- Corless Eliza Miss, waiter Mansion House
- Cornwell Enos J., bookbinder Union Block 34 Main, h 41 Prospect
- Cornwell Norman S., janitor Public Library, h 210 Main
- Corron Turfield, h Water, Leeds
- Cosmian Hall, Main c Meadow, Florence
- Costello Edmund, h Hinckley
- Costello James, emp C. A. Maynard, h King
- Costello John, farmer, h Hinckley
- Costello Patrick, fireman, rem to Westfield, Mass
- Costello Phillip, farmer, h Hinckley
- Cote Joseph, laborer, h 59 Prospect c Chestnut
- Cote Lewis, laborer emp Amos Sawyer, h N Prospect
- Cote Leon, emp W Mfg Co., h 8 Pleasant
- Cote Louis, emp W Mfg Co., h 36 Williams
- Couch Bradford M., machinist, millwright and iron founder opp
freight depot, Florence, h 3 Cherry, N
- Couch Elbert N., foreman B. M. Couch, h N Main, Florence
- Couch Frank M., rem to Waterbury, Ct
- Coughlin Alice M., emp B Bros & Co., bds Beacon, Florence
- Coughlin John, laborer, bds Bridge, Florence
- Coughlin Kate E. Miss, clerk J. E. Riley, bds Beacon, Florence
- Coughlin Patrick, laborer, h 74 Pleasant
- Coughlin William, weaver, h Massasoit
- County Clerk's office, Court House, Main
- County Treasurer's office, Lewis Warner treas., 112 Main
- Courselle, Auzet, emp N S Co., h 4 Warner's Row, Leeds
- Court House Main c Gothic
- Courtney Michael, laborer, h Hospital Hill
- Courtwright Jane A. Mrs., h 55 Bridge
- COUTURE EUSEBE**, baker and grocer 10 Market, h do. [See p
262]
- Couture Louis, baker, h 9 Market
- Cowing Dwight T., traveling agent A. E. Steele, bds 6 Cherry
- Cowing Henry F., traveling salesman Tigerite Mfg Co., bds 6 Cherry
- Cowing Richard A., (S. D. Hadley & Co.), rooms 98 Main
- Cowing Zalmon D., optician, 6 Cherry, h do
- Cowles Hattie B., widow Lewis B., bds 38 Maple
- Cox Henry, laborer, h off Water, Florence
- Crafts David W., supt., N Gaslight Co., office 105 Main, h Crafts av
n Main
- Crafts Josephus, broker, h 29 Market
- Crafts Perry F., painter, rem to Conway, Mass
- Crafts Thomas S., farmer, h 23 Bridge
- Crager Henry, mason, N Silk Co., h West, Leeds

- Crampton James, laborer, h Water, Leeds
 Crampton Mary Miss, domestic Mansion House
 Crandall Francis sawyer, bds 109 South
 Crane B. H., widow D. M., h 12 Green
 Crane Maria E., widow Edward, h Mill, Bay State
 Crane Sophia L., widow Jared, h 14 Market
 Crannage James, moulder, h Summer n State
 Crier Sarah W., widow John, h Spring, Florence
 Critchlow Alfred Mrs., h off Nonotuck, Leeds
 Crittenden Charles E., emp F Mach Co., h Washington place
 Crittenden George F., salesman Nonotuck P B Co.; h Gothic c Allen
C **RITTENDEN GEORGE W.**, dentist, 114 Main, rooms do. [See p 244.]
 Crittenden Rufus, machinist, h 14 Maple
 Cronen John, emp G Mfg Co., bds 30 Maple, Florence
 Crooks Edgar F., manager B Bros & Co., h Hawley c Hancock
 Cross Alfred E., manager Bay State Telephone Co., 92 Main, rooms 5 Pleasant
 Crosby Charles M., bds 13 Clark av
 Crosby Henry A., farmer, Chesterfield road, Leeds
 Crossley Azro T. (Parsons & Crossley) attorney-at-law 52 Main, h Grant av n Bridge
 Crossman Fred., tin smith, bds Park, Florence
 Crotty Dennis engineer M R Butron Co., bds Main, Leeds
 Crotty Patrick, emp Button Co., bds Cook House, Main, Leeds
 Crotty Thomas, emp M R Button Co., h Cook House, Main, Leeds
C **ROUCH CHARLES S.**, carpenter, 26 Pleasant, h do. [See p 270.]
 Crouch C. S. Mrs., dress scale, h 26 Pleasant
 Crouch Frederic A., carpenter, emp C. S. Crouch, bds 26 Pleasant
 Cruden James, emp G Mfg Co., h 9 Nonotuck, Florence
 Cruess Thomas S., machinist, N Silk Co., h Holyoke, Florence
 Crowley James, laborer, h Chesterfield road, Leeds
 Crowley James E., blacksmith, emp J. Rowe, bds Chesterfield road, Leeds
C **RYSTAL EMERY WHEEL CO.**, Hawley n Main [See p 235.]
 Cuddihey James, laborer, h State n Perkins av
 Cullinan Stacia Miss, h Franklin
 Cummings William, emp B Bros & Co., bds 19 Hawley
 Cunningham James, moulder, h Center, Florence
 Cunningham Mary E. Mrs., h 70 N Maple Florence
 Curran John, emp M R Button Co., bds Leonard, Leeds
 Curran Michael J., expressman, h Leonard, n Front, Leeds
 Currier Edward, emp F Mach Co., bds 10 Chestnut, Florence
 Currier Ellis B., clerk Lincoln & Bell, h 21 Pleasant
 Currier Frederick P., carpenter, h 16 Franklin av
 Currier Julia J. Miss, clerk Lincoln & Bell, bds 3 South
 Currier Mary Miss, milliner, bds 3 South
 Currier William, h 10 Chestnut, Florence
 Currier William Jr., carpenter, bds Chestnut, c High, Florence

- Curtin James laborer, h West; Florence
 Curtis John, emp S. Carr, bds Pleasant n Williams
 Curtis Willard A., emp F F Co., h N Main, Florence
 Cushing Abner M., truckman, h 6 Maple
 Cushing Arthur M., rem to Springfield
 Cushing Eleanor P., Miss, teacher of Mathematics Smith College, bds
 Dewey House
 Cutler Artemus H., bds 14 Maple, Florence
 Cutler Cecil S., physician, h Main Florence
 Cutler George T., (Cutler, Plimpton & Co.), bds 14 Maple, Florence
 Cutler Henry F., (Cutler, Plimpton & Co.) post master, h Maple F
 Cutler Mary S., Miss, bds 14 Maple, Florence
 Cutler, Plimpton & Co., (Henry F. Cutler, Lewis F. Plimpton, George
 T. Cutler) grocers, dry goods, &c., Maple c West Center, F.
 Cutler Thomas B., printer emp GAZETTE office, h 52 Elm
 Cutter Fred G., rem to Springfield
 Cutter Lewis, carpenter, h 22 Williams
 Cutting Daniel F., plumber emp W. F. Prindle, h 13 South
- DADY EDMUND**, laborer, h Nonotuck, F
 Dady Edmund Jr., bds Nonotuck, F
 Dady Patrick, moulder F Mach Co., h Nonotuck, F
 Dailey John, emp C R Lumber Co., bds Mt Tom
 Dakin Chester H., station agt., N H & N R R h 4 Phillips Place
 Daley Patrick J., dry goods and refreshment saloon. Water, F, h do
DALRYMPLE E. O., proprietor Nonotuck House, Pleasant, c
 Pearl. [See p 266.]
 Dalton Annie S., widow Patrick, h Main, Leeds
 Dalton Richard, painter, bds Lincoln av
 Dalton William, M R B Co., bds Main, Leeds
 Daly James laborer, h Pine c Maple F
 Daly Maggie Miss, emp G Mfg Co., bds 90 Maple, F
 Daly Sarah L. Mrs., bds 8 Strong av
 Damon Alice R., emp L. J. Warner, bds Elm n Silk Mill
 Damon Angie M. Miss, emp L. J. Warner, bds Elm n Silk Mill
 Damon Arthur E., emp F Mach Co., h 70 N Maple, F
 Damon Caleb M., laborer, h Grant av
 Damon Edward O., Pres Damon Narrow Fabric Co., h 25 Pomeroy
 Terrace
 Damon Ella G., bookkeeper A McCallum, bds 2 Maple
 Damon Elmer E., teamster, bds Grant av
 Damon Isaac, car repairer h 13 King
 Damon Lucilla Miss, h 10 Bridge
 Damon Moses G., emp W Mfg Co., h Massasoit
DAMON NARROW FABRIC CO., Pleasant c Strong av. [See p
 237.]
 Damon Oscar J., supt Almshouse, Prospect
 Damon William R., teamster, bds 167 Main
 Dance Charles, engineer Smith College, h 9 Green
 Daniels Charles A., baker emp Lyman & Shipman, h Summer c State
 Daniels Charles H., machinist, h Arlington

- Daniels Emma, widow Edward R., h 22 King
 Daniels George H., printer emp Hampshire County Journal, h Summer c State
 Daniels John W., h 18 Franklin
 Daniels Martha S., h Summer c State
 Daniels Patrick, laborer, h King c North
 Dannehy Edward, laborer, h Mill Yard
 Dargan Timothy, laborer, h off N King
 Darrow W. V. Mrs., h Fruit, Florence
 Dart F. A. Miss, Hubbard House Smith College, Elm
 Dathe Franz, emp B Bros & Co., bds 24 Hawley
 Daugherty Cyrus P., clerk Cutler, Plimpton & Co., bds 7 Main, F
 Daveau Louis, carpenter, h Market
 Davenport E. C., wallet maker emp N P B Co., h r 7 Park
 Davenport Joseph N., dentist 62 Main, h 27 Elm
 Davidson Edward, rem to Chicago
 Davis Anthony, mason, h River road, Leeds
 Davis Charles, tinner emp W. F. Prindle
 Davis Charles H., clerk Clark & Parsons, bds 9 South
 Davis Charles T., machinist, bds Lilly n N Main Florence
 Davis Emory C., surveyor and civil engineer 114 Main, h 34 N Main, Florence
 Davis Elizabeth Mrs., rem to Springfield
 Davis Eugene E., surveyor emp E. C. Davis, bds 34 N Main, Florence
 Davis Frank M., emp F Mfg Co., bds Lilly, Florence
 Davis George, (R. B. Davis & Co.), h 13 Clark av
 Davis Jehiel M., emp F Mfg Co., h Lilly n N Main, Florence
 Davis-Lucius S., (O. Edwards & Co.), bds Center opp Masonic
 Davis Nelson A., druggist, Davis Block Main, Florence, h do
DAVIS R. B. & CO., (Richard B. Davis, George Davis), carriage manufacturers and blacksmiths, 11 South. [See p 275.]
 Davis Richard B. (R. B. Davis & Co.), h 9 South
 Davis Richard B. Jr., carriage blacksmith emp R. B. Davis & Co., h 19 Franklin av
 Davis Samuel, carpenter, h 16 Olive
 Dawson Lucian A., broker, h Round Hill
 Dawson Mary B., widow Elziur, h 12 Holyoke
 Dawson Mary I. Miss, h 9 Washington av
 Day Festus B., sewing machine agent, W & W Mfg Co., h Arlington
 Day Frank, emp N Emery Wheel Co., bds North
 Day Frank H., travelling salesman, h 62 King
 Day Frank S., emp N Emery W Co., bds Leonard, Leeds
 Day Henry, laborer, bds Pine Grove
 Day Henry C., travelling agent, bds 62 King
 Day, Hiram, town treasurer and collector, h 62 King
 Day John, grinder C Cutlery Co., h Main, Bay State
 Day Joseph, cutler, h Hinckley, Bay State
 Day Joseph C., bds 32 Elm
 Day Joseph S., mason, h 13 Vernon
 Day Leonard, (N. Day & Bros.), h 37 South
 Day Lewis, rem West Springfield

- Day Louis A. emp J. L. Lord, bds 13 Vernon
 Day Luke, night watchman Smith College, h 72 Bridge
 Day Matilda Mrs., cook N L Hospital, bds do
 Day Michael, laborer, bds 48 Bridge
 Day Myron, farmer, h North
 Day Nathaniel, (N. Day & Bros.) h South n brick yard
 Day N. & Bros., (Nathaniel. William and Leonard), brick mfg and
 steam saw mill, South opp Hospital Hill
 Day Samuel C., emp Dickinson & Pomeroy, h 167 Main
 Day William, (N Day & Bros.) h South n brick yard
 Day William H., (Lee & Day), h 8 Clark av
 Dayton Fred A., carpenter, h King
 Deady James, painter, bds Bates
 Deady Jeremiah, laborer, h Bates
 Dean Mary A. Mrs., h off West, Florence
 Deane Thomas, blacksmith, Nonotuck n Main, h do Florence
D **DEARDEN WILLIAM**, crockery and paper hangings 32 Main, h
 25 Pleasant. [See p 250.]
 Debros, Louis, carpenter, h Walnut
 Degnan Ellen, widow Thomas, h off Green
 Deiner Julius, emp B Bros & Co., bds 33 Pleasant
 Deitrich see Dietrich
 Delano Charles G., attorney-at-law 113 Main, bds Bates
 Delano Jesse L., (Sanderson & Delano), h Sanderson av
 Delano Sarah G., widow Charles h Bates
 Delano Winthrop, bds Bates
 Delaney John, emp G Mfg Co., bds 24 River, Florence
 Delaney Patrick, emp F Mach Co. h 24 River, Florence
 Delaney Peter, emp N Cutlery Co., bds Water, Florence
 Delaney William L., mechanic, bds Loudville
 Dellehunt Mary, widow Hartly, h Green
 Demond J. Howe, h 49 Elm
 Dement Charles A., emp T. A. Orcutt, bds Pine, Florence
 Deming Charles B., emp W Mfg Co., h 11 Maple
 Dempsey James, emp Clement Mfg Co., bds Main Bay State
 Dempsey John, rem to Newark, N. J.
 Dempsey Patrick, emp F Tack Co., bds South, Florence
 Denn Mary, widow William, h Bridge, Florence
 Denn Mary, widow Edmund, h West, Florence
 Denn Minnie E., Miss, clerk J. E. Riley, bds Bridge, Florence
 Denn William, foreman Landy Bros., h Lake, Florence
 Denniston Anna Miss, h 9 Elm
 Derosier George, emp Gilbert Derosier, bds Pleasant
D **DEROSIER GILBERT**, carriage maker, Main opp Masonic, h
 Pleasant. [See p 276.]
 Derosier Joseph, brick maker, h Pleasant c Williams
 Derosier Peter D., hostler, emp H. G. Holley, bds 206 Main
 Derosier, see Rosebush
 Derrick Hiram, emp W Mfg Co., h 8 Main
 Derrigan Timothy, laborer, h off N King
 Desmond Jeremiah, gardener L. B. Williams, h Clark av

- Detter Samuel, laborer, h Grant av
 Deuto Lewis, h Pleasant c Williams
 Deuto Nelson, emp W Mfg Co., bds Pleasant c Williams
 Devine Bridget, widow Michael, h North King
 Devine John, emp F Mach Co., bds 12 N Main, Florence
 Devine John, rem to State of N. Y.
 Devine Patrick, laborer, h n N King
 Devlin Michael, emp N Silk Co., h Main, Leeds
 DeWare Kate, widow Patrick, h 60 Pleasant
 Dewey Elroy, sawyer, h 32 Center
 Dewey Everett H., rem to Williamsburg, Mass
 Dewey Henry W., agt American Express Co. and United States and
 Canada Express, 26 Main, bds 11 King
 Dewey John T., saloon 159 Main, h Masonic
 Dewey Mark, emp U. S. & C. Express, bds 13 King
 Dewey Mortimer A. Mrs., h 10 Holyoke
DEWY PATRICK H., liquor dealer 141 Main, h 17 State
 [See p 283.]
 Dibble Edward, farmer, h North Farms
 Dibble Frank, tin smith Shumway & Riley, bds Lilly n N Main F
 Dickinson Arthur L., clerk J. W. Bird, bds 15 Park, Florence
DICKINSON CHARLES H., milliner and fancy goods 88 Main,
 h 21 Market. [See p 251.]
 Dickinson Charles H., Jr., rem to Deerfield
 Dickinson Charles H., bds 22 Pomeroy Terrace
 Dickinson Edward, machinist emp W Herrick, h 12 Maple
 Dickinson George F., carpenter, h N Main, Florence
DICKINSON GEORGE F., baggage express, office 90 and 125
 Main, h Prospect n Spring. [See p 274.]
 Dickinson George P., h 57 Elm
 Dickinson Henry, paper manf., h 22 Pomeroy Terrace
 Dickinson Lyman P., carpenter, h 15 Park, Florence
 Dickinson Mary E. Mrs., dress maker 74 Main, rooms do
 Dickinson Mattie I. Miss, clerk 64 Main, rooms 74 do
 Dickinson Nettie Miss, bds 12 Maple
 Dickinson R. B. Mrs., h 2 Phillips Place
 Dickinson Samuel G., (Dickinson & Pomeroy), h 8 King
 Dickinson Simeon, h 11 Pomeroy Terrace
 Dickinson William, emp 45 Pleasant, bds do
 Dickinson William, machinist, bds 23 Pleasant
 Dickinson Wm. P., Mrs., h Market
DICKINSON & POMEROY, (Samuel G. Dickinson, Charles R.
 Pomeroy), livery stable, Center n Main. [See p 279.]
 Dietrich Christian, h Elm St. House, Elm
 Dietrich Frank E., proprietor Elm St. House, bds do
 Dietrich Peter, joiner, h N Elm
 Dietrich Peter Jr., bds N Elm
 Dihey Michael, emp E. Paper Co., bds Loudville
 Dikeman Henry, h 1 North
 Dillon Lewis T., machinist B. M. Couch, h 13 Market
 Dimick Lewis C., foreman preparing room N Silk Co., bds Grove av,
 Leeds

- Dimick Rodney S., emp N Silk Co., bds Grove av, Leeds
 Dimick S. Otis, emp N Silk Co., bds Grove av, Leeds
 Dimock Augustus H., farmer, h Pine Grove
 Dimock Ira, pres Nonotuck Silk Co. and N Emery Wheel Co., res
 Hartford, Conn
 Dimock Lucius, agt N Silk Co., h Grove hill, Leeds
 Dinn Mary, widow Edmund, h off West, Florence
 Dinn William, h Oak, Florence
 Dinsmore Alvin D., carpenter, h West Farms
 Dinsmore Henry, painter, h Summer
 Dinsmore William J., bds Masonic n Center
 District Court, 46 Main
 Ditty Erie L., rem to Brookfield, Vt
 Dolan John, laborer, h Warner, Bay State
 Dolan Patrick, cutler N Cutlery Co., h Cutlery blk, Bay State
 Dole Benjamin P., rem to Hatfield
 Dominique Richard B. A., emp W Mfg Co., h 3 Holyoke
 Donahue Annie Miss, emp G Mfg Co., bds High n R R, Florence
 Donahue Johannah, widow John, h Nonotuck, Florence
 Donahue John, emp Lee & Day, bds 1 Masonic
 Donelson Elsie Miss, compositor H Co. Journal, bds 10 Cherry
 Donovan Edward, emp Mill River Button Co., bds Spring, Florence
 Donovan James, h Spring, Florence
 Donovan James, h West, Florence
 Donovan James, farm hand, bds Pine Grove
 Donovan John, emp M R Button Co., h Main, Leeds
 Donovan Kate, widow Lawrence, h Loudville
 Donovan Matthew, (Donovan & Purcell), h Main, Leeds
 Donovan Michael, laborer, h Spring, Florence
 Donovan Michael, laborer, h King
 Donovan Nora Miss, laundress Mansion House
 Donovan Patrick, teamster, bds Nonotuck, Florence
 Donovan William, laborer, h Mill Yard
DONOVAN & PURCELL, (Matthew Donovan, Patrick Purcell),
 grocers, &c., Main, Leeds. [See p 261.]
 Dooley Andrew, rem to Greenfield
 Dooley Daniel, laborer, h Ox Bow
 Dooley Matthew, cutler, h 39 Vernon
 Doolittle Lucy A., Miss, teacher Kindergarten, F, bds Park, Florence
 Dopman Anna, widow George, h State ab Spring
 Doran John, laborer, h r 15 Gothic
 Dorsey John, emp N Cutlery Co., h Warner, Bay State
 Dorsey John J., emp J. A. Sullivan, bds Market
 Dorsey Margaret, widow Thomas, h 32 Market
 Dorsey Martin, laborer emp Amos Sawyer, h n North Elm
 Dorye Joseph, emp C. T. Parsons, bds 3 Maple
 Douglass Henry, canvasser, h 9 Fruit
 Douglass James J., attendant N L Hospital, bds do
 Douglass Mary A., widow William B., h 19 Summer
 Douglass William J., attendant N L Hospital, bds do
 Dow Edgar A., janitor Kindergarten school, h r of school, Florence

Dowd Dennis, laborer, h South
 Dowden Bridget Miss, housekeeper 13 Maple n Pine, Florence
 Dower Ellen, widow John, bds Massasoit
 Dower John A. agent, h Massasoit
 Doyle John, paper maker, h College av
 Doyle John, emp E Paper Co., bds Loudville
 Doyle Kate Miss, domestic, Mansion House
 Doyle Margaret, Mrs., h South, Florence
 Doyle Mary, widow John, h Mill Yard
 Doyle Michael, emp W Mfg Co., bds Mill Yard
 Doyle Michael, emp N H & N R R, h Mill Yard
 Doyle Patrick, laborer, bds Mill Yard
 Doyle Richard, laborer, 19 Maple, bds do
 Dragon Ameda, emp L. Dragon, bds State
 Dragon Louis, barber, shop 111 Main, h State ab Spring
 Dragon Oliver, (Laframboise & Dragon,) h 13 Perkins av
 Drake Arthur G., clerk C L. Hyde, h Main n Holyoke, Florence
 Draper Albert L., tinner emp Lee & Day, h 2 Walnut
D **DRAPER JOHN L.**, Mansion House livery stable r Carr's block
 Main, h 18 Union. [See p 279]
 Draper John W, plumber, emp W. F. Prindle, bds 2 Walnut
 Draper Lewis L., real estate, h 18 Union
 Drase Hermann, farm laborer, bds Pine Grove
 Drohen David, emp F Mach Co., bds Water, Florence
 Drohen Jeremiah, emp N H & N Co., bds Chestnut
 Drohen Thomas, emp G Mfg Co., bds Water, Florence
 Drummond Andrew, emp B Bros & Co., bds 33 Pleasant
 Drury Fred H., clerk E. A. Brooks, rooms 47 Elm
 Drury George B., sup't of schools, office Town Hall, h 7 Clark av
 Drury George H., bds 7 Clark av
 Drury S. Dwight, book keeper N Institution for Savings, bds 8
 Strong av
 Duball F., baker, emp Mrs. M. K. Olney, rooms 7 State
 Dubreul Lewis, carpenter, h 16 Walnut
 Ducharme Oliver, emp N Silk Co., h Water, Leeds
 Ducharme William, emp N Silk Co., h Water, Leeds
 Ducharme Xavier, emp N Silk Co., h Reservoir road, Leeds
 Duchesne Frank, emp W Mfg Co., h River
 Duchesne John, rem to Hartford, Ct
 Duchesne Alphonso P., barber, rooms 20 River
 Dudley Lewis J., h 50 Gothic
 Duffey John, emp N Cutlery Co., h Warner, Bay State
 Duffey William, inspector, bds 36 Main, Florence
 Duffy John, rem to Westfield
 Dufresne Mary A. Mrs., h N Main, Florence
 Dufus Otto, emp B Bros & Co., bds 24 Hawley
 Duggan David, farmer, h Spring, Leeds
 Duggan David Jr., farm hand, h Critchlow, Leeds
 Duggan James, laborer, h College av
 Duggan James Jr., polisher, bds College av
 Duggan James, emp M R Button Co., h Spring, Leeds

Duggan John, laborer, bds Spring, Leeds
 Duggan John, emp M R Button Co., h Main, Leeds
 Duggan Thomas, bds Spring, Leeds
 Dumas Louis, foreman weaving room, B Bros & Co., h 23 King
 Dumphy Edmund, laborer, h West, Florence
 Dumphy James, laborer, bds Franklin n Prospect
 Dumphy John, teamster, h Front
 Dumphy Patrick, emp Gas Co., h Lawn av
 Dunlap James, physician, 92 Main, rooms do
 Dunn Alice, widow Stephen, h n Nonotuck, Florence
 Dunn Edmund, emp E Paper Co., bds Loudville
 Dunn James, laborer, h Front n Williams
 Dunn James, emp W F Prindle, h 60 Pleasant
 Dunn Johanna Mrs., h off Nonotuck, Florence
 Dunn John, rem to Springfield
 Dunn John, emp W Mfg Co., h Williams opp Front
 Dunn John D., laborer, h Mill Yard
 Dunn Kate Miss, emp Mansion House
 Dunn Michael, emp W Mfg Co., h Front
 Dunn Michael, emp W Mfg Co., h 64 Pleasant
 Dunning Elson I., machinist, bds Fruit c High, Florence
 Dunning Ira A., wheelwright B. M. Couch, h Lake, Florence
 Dunphy Andrew, laborer, Franklin
 Dunphy James, emp Clement Mfg Co., bds Warner, Bay State
 Dunphy Patrick, laborer, h Bates
 Duplissis William, rem to Spencer, Mass
 Durant Levi, farmer, Smiths Ferry
 Dusenbury John, teamster, h Chestnut n Main, Florence
 Dwyer Martin, laborer, h Water, Florence
 Dwyer Nellie T., Miss, emp N Silk Co., bds South, Florence
 Dwight Alice E., Miss, teacher, bds 24 Pleasant
 Dwight Elizabeth A. Miss, teacher, bds 24 Pleasant
 Dwight Mary B., matron Miss Burnham's school, 17 Elm
 Dwight Nellie A. Miss, teacher, bds 24 Pleasant
 Dwight M. D., widow Henry A., h 24 Pleasant
 Dwight Theodore F., book keeper, bds 24 Pleasant
 Dwyer Michael, laborer, h 7 Nonotuck, Florence
 Dyer E. Alden, physician, rem to Southampton

EAGAN ARTHUR, emp N Cutlery Co., bds Maple, Bay State
 Eagan Charles W., assistant baker N L Hospital, bds do
 Eagan Edward, emp N Cutlery Co., bds Maple, Bay State
 Eagan John, emp N Paper Co., bds Mill, Bay State
 Eagan John, emp N Cutlery Co., h Maple, Bay State
 Eagan Margaret Mrs., bds Maple, Bay State
 Eagan Mary, widow John, h Mill Yard
 Eagan Mary, widow Garrett, h Warner, Bay State
 Eager Jennison, assist book keeper M R Button Co., bds 32 Elm
 Eager Laura E. Mrs., h 32 Elm
 Eager Oliver E., clerk C R R freight depot, bds 32 Elm
 Eames George D., (Eames & Sprague), h 13 Hawley

- EAMES & SPRAGUE**, (George D. Eames, Stephen D. Sprague), stove dealers and gas fitters and plumbers, 24 Main. [See p 264.]
 Earle Francis C. Miss, assist clerk N L Hospital, bds do
 Earle Harriet Miss, h 4 Maple
 Earle Pliny, M. D., supt N L Hospital, h do
 Earles Thomas, laborer N L Hospital, bds do
 Eastman Abiel, h 33 Gothic
 Eastman Charles A., emp Kimball & Cary, h North n Lincoln av
 Eaton Adif, emp L W Smith, bds do
 Eaton Casper, emp B Bros & Co., bds 22 Walnut
 Eaton Homer, clerk Fearing & Everett, bds 18 Union
 Eaton Melchoir, fireman B Bros & Co., h 22 Walnut
 Edgerton Wm E., painter, emp John Tyler, room Clapp & Johnson's block, Main
 Edwards Ann, widow Lewis B., h beyond Gas Works, River
EDWARDS BROTHERS, (Frank Edwards, Calvin B. Edwards, Jr.), grocers, Mansion House Block, 133 Main. [See p 260.]
 Edwards Calvin B., bookseller, h 21 Gothic
 Edwards Calvin B., Jr., (Edwards Bros.), bds 21 Gothic
 Edwards Charles H., emp A. Kingsbury & Son, bds 41 Bridge
 Edwards Charles S., h 45 South
 Edwards Church, (Rev Isaac Clark), Main c State
 Edwards Duane, lithographer Star Printing House, bds Bates
 Edwards Ebenezer, farmer, Spring c State
 Edwards Frank, (Edwards Brothers), bds 21 Gothic
 Edwards Fred L., farmer, h off Bridge
 Edwards George W. Mrs., h 41 Bridge
 Edwards George F., clerk A. McCallum, bds 41 Bridge
 Edwards Henry L., Western Loans 108 Main, h 61 Elm
 Edwards Henry O., eating saloon 135 Main, h 13 Union
 Edwards James H., farmer, h Pine Grove
 Edwards Luther H., carpenter, Union, h 17 Union
 Edwards Oscar, (O. Edwards & Co.), Pres N National Bank, h Elm c Prospect
 Edwards Oscar W., clerk N Inst for Savings, bds Elm c Prospect
EDWARDS O. & CO., (Oscar Edwards, Lucius S. Davis), druggists, grocers, paints, oils, &c., 100 Main. [See p 256.]
 Edwards Robert E., (Searle & Edwards), h 8 Park
 Edwards Sarah, widow Joseph, h 76 South
 Edwards Thomas, gardener, h 17 Union
 Edwards Wm. S., farmer, h Pine Grove n Florence
 Eggleston Austin, mechanic F Mach Co., h Lilly n Meadow, Florence
 Eggleston Charles H., teamster, bds Arlington
 Eggleston Duane H., painter, h 6 Main, Florence
 Eggleston Hannah Mrs., dress maker Lilly, Florence, h do
 Eggleston Henry, stone mason, h Arlington
 Eggleston James H., spool turner, h Nonotuck, Leeds
 Ehrenfechter Julius, die sinker, emp E N Foote & Co., bds 7 State
 Elder Edward H., bds Lilly, Florence
 Elder Ella C. Miss, teacher Kindergarten, bds Lilly, Florence
 Elder Frank, laborer, h Hospital Hill

Elder Washington mechanic F Mach Co., h Lilly, Florence
 Eldredge Alexander M., painter, bds Lilly n N Main, Florence
 Eldredge Alfred C., rem to Milford, Mass
 Eldredge Amos, carpenter, h Park, Florence
 Eldredge, George L., B Bros & Co.'s, boarding house, Williams
 Eldredge Mary, widow Benj. C., h Lilly n N Main, Florence
 Ellis Austin, farmer, h North Farms
 Ellis Willard C., basket maker, h Hospital Hill
 Ellsworth George, farmer, h 63 South
 Ellsworth James, farmer, h 49 South
 Elm Street House, F. E. Dietrich proprietor, Elm Junc N Elm
 Elmer Myron, driver Smith Carr, h r 7 Strong av
 Elmer Perry, machinist, emp W Herrick, bds Smith
 Elmer Sarah A. Mrs., h Smith
 Elwell Frank R., farmer, h Bridge n Water
 Elwell Henry Mrs., h Bridge n Water
 Elwell Levi H., teacher, bds Bridge n Water
 Elwell Moses, farmer, h 83 Bridge
 Ely Oscar F., clerk Cutler, Plimpton & Co., h High, Florence
 Emerick Daniel, farmer, h North Farms
 Emerson Garry H., joiner, bds Meadow c Lilly, Florence
 Emery Eliza A., widow Amos B., h 54 Elm
 Ennis Ellen, widow John, h 26 Walnut
 Ennis Thomas, carpenter, bds 26 Walnut
 Ensign Henry N., fancy goods 94 Main, agent Domestic Sewing
 Machine, h 18 Walnut
 Ensign Lois M., widow William, bds 18 Walnut
 Estabrook Alanson C., Supt Florence Mfg Co., h 10 Prospect, Florence
 Estelle Abba B., widow Samuel, h Prospect, Florence
 Estelle Vercel L., moulder, h Prospect, Florence
 Estes Amy, emp Nonotuck Silk Co., rooms Fruit n Main, Florence
 Esty Henry W., attendant N L Hospital, bds do
 Etea Joseph, painter, bds 20 River
 Etu Peter, barber, emp basement Mansion House, bds Perkins av
 Eustis Alonzo, h Holyoke c Hawley
 Eustis J. G., farmer h West, Leeds
 Everett Francis O., (Fearing & Everett), bds Mansion House
 Ewing Alexander, farmer, h Pine Grove
 Ewing Alexander M., emp N Silk Co., bds Front, Leeds
 Ewing Samuel A., overseer N Silk Co., h Front, Leeds
 Eyre John, cutler, Hinckley, h Bay State
 Eyrie House, William Street propr., Mt Tom

FAAS FREDERICK, farmer, h Chesterfield road, Leeds
 Faas Charles S., emp N S Co., bds Chesterfield road, Leeds
 Fagan George, emp N H & N Co., bds King at R R crossing
 Fagan Patrick, laborer, h King
 Fagan William, emp C A Maynard, h Pleasant
 Fairweather James H., High c Fruit, Florence
 Fanion Octavia, barber, 197 Main, h Cottage Place
 Fanning Edmund, laborer, h River, Florence

Farland Jeremiah, emp H. E. Smith, h Williams, opp Front
 Farley Phebe, widow, h Main, Bay State
 Farnham Frank, emp F Machine Co., h Chestnut, c High, Florence
 Farr Chas. R., carpenter and builder, h 13 Franklin av
 Farrand Moses, emp N Silk Co., h River, Florence
 Farrand Thomas E., emp N Silk Co., h off Water, Florence
 Fayhee James, laborer, h Hinckley, Bay State
 Fayhee John, moulder, h Spring, Leeds
 Fayhee Lawrence, farm hand, bds Chesterfield road, Leeds
 Fayhee Michael, h Main, Leeds
 Fayhee Michael, mason, h Chestnut
 Fearing Alfred G., (Fearing & Everett), bds Mansion House
FEARING & EVERETT, (Alfred G. Fearing, Francis O. Ever-
 ett) dry goods and carpets, 86 Main. [See p 249.]
 Felton Anna C., Miss, h River
 Felton Nathan A., dresser tender, Damon Narrow Fabric Co.; h Hos-
 pital Hill
 Felton R. H. Miss, h 11 River
 Felton William H., h Hospital Hill
 Fenner Alice Miss, h Roberts Meadow
 Fennessey James, emp M R Button Co., h Main, Leeds
 Fennessey Mary Mrs., domestic, Florence House, F., bds do
 Fennessey Michael, laborer, h N Elm
 Fenton Daniel, emp Horace Lamb & Co., h Fort
 Fenton Ellen Mrs., h Critchlow, Leeds
 Fenton Thomas, laborer, h Mill Yard
 Feringer Sidonia, h rear 15 Gothic
 Fernald George N., farmer, h North Farms
 Fernale Lewis, emp F Mach Co., bds Fruit c High, Florence
 Ferrell Hannora, widow, h Loudville
 Ferris James, watchman Hoe Shop, h Florence Road
 Ferris James Jr., farmer, bds Florence road
 Ferris Patrick, farm hand, bds Florence Road
 Ferry Charles B. Rev., h 40 Elm
 Ferry Henry M., farmer, bds 55 South
 Ferry Henry N., emp Clapp & Johnson, bds 55 South
 Ferry Lemuel C., book-keeper M. W. Jackson, h 57 South
 Ferry Phineas, rem to Mittineague
 Ferry Sydenham N., book-keeper Clapp & Johnson, h 55 South
 Feicker Charles L., clerk E. A. Brooks, bds Main, Bay State
 Feicker Edward, book-keeper N Cutlery Co., bds Main, Bay State
 Feicker Fred C., machinist, N Cutlery Co., h Main, Bay State
 Feicker C. Fred., emp F Machine Co., h Main, Bay State
 Field Charles H., emp N Silk Co., bds Center c Front, Leeds
 Field David J., laborer, h Grant av
 Field Frank W., carpenter, emp N Silk Co., h Center, Leeds
 Field George D., lawyer, with D. W. Bond, Jones Block, res Spring-
 field
 Field Henry P., lawyer, with J. C. Hammond, over First National
 Bank, bds Center av
 Field Jennie Miss, teacher, bds 25 Market

Field Lemuel B., foreman N S Co., h Chestnut av, c Center and Front
 Field Robert R., carriage maker, emp R. B. Davis & Co., bds 9 South
 Field Sylvia, widow Alvin S., h 23 Market

FIELD ZENAS, building mover, h Hockanum road. [See p 275.]

Finch Baxter R., machinist, bds Chesterfield road, c Spring, Leeds

Finch John W., h Chesterfield road c Spring, Leeds

Finch John W. Jr., mason bds Chesterfield road c Spring, Leeds

Finch Wesley, emp N Silk Co., h Chesterfield road, Leeds

Finn Daniel, rem to Greenfield

Finn John, cutler N Cutlery Co., h Main, Bay State

Finn Martin, laborer, h Mill Yard

Finn Patrick, cutler N Cutlery Co., h Maple, Bay State

First Congregational Church, Main c Center

FIRST NATIONAL BANK of Northampton, Main c King. [See p 228.]

Fischer Jacob, emp B Bros., & Co., bds State c Bright

FISH FRANCIS W., cabinet maker, rear Jones Block, Court, h Cherry. [See p 263.]

Fish Hamlin W., emp Clement Mfg Co., bds Hinckley, Bay State

Fisher Frank A., harness maker, emp Hayes & Burby bds 12 Walnut

Fisher Joseph, emp Clement Mfg Co., h Union, Bay State

Fiske Franklin C., clerk D. J. Wright, h Grant av

Fisk Fannie Miss, dressmaker, 5 Market

Fiske George Mrs., h North Farms

Fisk James J., teamster, h 5 Market

Fisk Milton M., produce dealer, h 18 Williams

Fiske Nancy, widow George, h North Farms

Fiske Samuel A., physician, h King

Fitts Charles N., clerk A. McCallum, bds 5 Henshaw av

Fitts Lucy M. Mrs., h 5 Henshaw av

Fitzgerald Edward, laborer, h Chestnut

Fitzgerald Ellen Mrs., h Hinckley

Fitzgerald Elizabeth Miss, domestic, Hampshire House

Fitzgerald Eugene, hostler, Dickinson & Pomeroy, h Chestnut

Fitzgerald Hugh, joiner, h South, Florence

Fitzgerald Hugh, emp N Silk Co., bds River, Florence

Fitzgerald James, emp N Cutlery Co., bds River, Florence

Fitzgerald James, bds South, Florence

Fitzgerald Margaret Miss, h Round Hill

Fitzgerald Patrick, laborer, bds River, Florence

Fitzgerald Patrick, emp N H & N R R, h Water, Leeds

Fitzgerald Paul, emp C Cutlery Co., h Main, Bay State

Fitzgerald Thomas, mechanic, bds 30 Maple, Florence

Fitzgerald Thomas h River, Florence

Fitzgibbon William, laborer, h Hinckley

Fitzpatrick Ann, widow James, h Winter

Fitzpatrick James, moulder, bds Winter

Flagg Ellen M. Mrs., h 40 Market

Flagg Martin, carpenter, h Meadow n Bridge

Flaherty Edmund, laborer, Florence, Leeds

- Flaherty Eugene, emp N H & N Co., h 7 Nonotuck, Florence
 Flaherty John, rem to Colorado
 Flaherty William, emp M R Button Co., bds Florence, Leeds
 Flanagan William H., h off Meadow, Florence
 Fleming Edward, laborer, h Mill, Bay State
 Fleming John W., clerk Lincoln & Bell, bds Masonic
 Fleming Martha C., widow John W., h Masonic
 Fleming Richard, laborer, h n South, Florence
 Fletcher Alfred M., professor of music, Smith College, h 15 Elm
 Fletcher Catherine Miss, instructor C I D Mutes, Round Hill, bds do
 Flint C. C. Mrs., h 16 Center, Florence
 Flood Charles R., silk worker N Silk Co., h 20 Park, Florence
 Flood Susan, widow James, h Elm n Silk Mill
FLORENCE CLOTHING STORE, C. O. Parsons manager, Maple
 c Main, Florence. [See p 253.]
 Florence Free Library, Miss Mary Fuller librarian, Maple, F
 Florence Furniture Co., mfrs caskets and coffins, Myrtle, Florence
 Florence Hotel, Michael Cooney prop, Main cor Maple, F
 Florence Machine Co., mfrs sewing machines and oil stoves, Main c
 Chestnut, Florence
FLORENCE MANUFACTURING CO., mfrs brushes, mirrors,
 &c., junc Nonotuck and Pine, Florence. [See p 236.]
FLORENCE SAVINGS BANK, Davis blk Main, Florence. [See
 p 226.]
 Florence Tack Co., Locust c Holyoke, Florence
 Flynn John, emp Brick Yard, h Federal, Bay State
 Flynn Patrick, watchman F Mach Co., h South, Florence
 Flynn Patrick, emp Clement Mfg Co., h Maple, Bay State
 Flynn Philip, laborer, h Nonotuck, Florence
 Flynn Thomas, laborer, h Gothic
 Foley Ella A. Miss, clerk Lyman & Shipman, bds 24 Center
 Foley Hannah B., widow Bartholomew, h South, Florence
 Foley John, laborer, bds Chestnut n Prospect
 Foley Mary, widow John, h Prospect c Winter
 Foley Peter, emp C. H. Brewster, h State
 Foley Timothy, laborer, h Chestnut
 Foley William, farmer, h Bridge, Florence
 Fontaine Benjamin, mason, h over 195 Main
 Foote Alvah, emp E. N. Foote & Co., h 7 Holyoke
 Foote Edward N., (E. N. Foote & Co.,) h High
FOOTE E. N. & CO., (Edward N. Foote, Lewis Warner), button
 mfrs, Masonic c Masonic av. [See p 236.]
 Foran Timothy, mechanic, bds Mill Yard
 Foran William, laborer, h Oak, Florence
 Forand Albert, barber basement Mansion House, h Perkins av
 Forand Peter, joiner, h Perkins av
 Ford Abbie L., widow Henry P., h 19 Hawley
 Ford Charles L., gardener S. M. Burr, h Pine, Florence
 Ford Hiram W., rem to Springfield
 Ford Roland, painter, h Center, Florence
 Fordham C. S., emp E. N. Foote & Co., bds 191 Main

Foren Maria Miss, domestic, Florence House, bds do
 Forgette Joseph, emp W Mfg Co., h Smith
FORRESTALL WALTER J., manager John Parnell's undertak-
 ing establishment, office Strong av opp N H & N depot, bds 20
 King. [See p 247.]
 Forrian Edmund, laborer, bds Maple, Bay State
 Forrian Richard, laborer, h Nonotuck, Florence
 Forster Richard, emp N Pocket Book Co., h Summer
 Forsyth William, machinist B. M. Couch, bds North Main, Florence
 Fortune John, laborer, bds Warner, Bay State
 Fortune Mary, widow John, h Warner, Bay State
 Foss Frederick, farmer, h Chesterfield Road, Leeds
 Foster Alma S. Miss, nurse, bds 3 Pine c Nonotuck, Florence
 Foster George C., book keeper C. A. Maynard 130 Main, bds Green n
 Hoe Shop
 Foster George G., carpenter, h High n R R, Florence
 Foster Horatio, rem to Drinker, Penn
 Foster John W., machinist, rem to Springfield
 Foster Zebard, blacksmith, h off Green n College av
 Fouche Edward, brick maker, h Pine, Florence
 Fountain Henry, emp brick yard, h Warner, Bay State
 Fourn Maria, table waiter Florence House, Florence, bds do
 Fowle John H., rem to Stillwater, Mich
 Fowler C. E., rem to Boston
 Fowler Joseph, laborer, bds 12 West
 Fox Charles, bar tender Nonotuck House, bds do
 Fox Frank S., gate keeper N H & N R R, bds Nonotuck House
 Frain Bridget, widow Martin, h Main, Leeds
 Frain George, emp M R B Co., h Florence, Leeds
 Frain James, rem to Waterbury
 Frain John, laborer, bds Main, Leeds
 Fraleigh Charles E., emp Lyman & Shipman, bds West Block, 12 River
 Fraleigh John M., emp F Mach Co., h Main, Florence
 Fraleigh William, emp L. J. Warner, bds Elm n Silk Mill
 Francis John L., expressman, h N Elm opp Spring
 Francis Vetile, blacksmith, Main opp Edwards Church, h 12 Market
 Frank A. J., musician, bds Main, Bay State
 Franklin Mary Mrs., rem to Haydenville
 Franz Mary Miss, domestic, 16 Main
 Franzen Peter, cutler, bds N Elm
 Frary Dexter, shoe maker 54 Main, h 6 Walnut
 Frary Edward N., tinner Eames & Sprague, bds State c Center
 Frary Helen Miss, milliner 94 Main, h 13 Maple
 Frary William H., traveling agent, bds 6 Walnut
 Frary William H., rem to Springfield
 Frasi Henry G., machinist, h 19 Center, Florence
 Frawley Lizzie, emp N Silk Co., bds off Meadow, Florence
 Frawley Bridget, widow William, h High, Bay State
 Frazier Alexander, sawyer, bds 109 South
 Fredericks Adolphus E., emp N Silk Co., bds Meadow, Florence
 Fredericks Christiana Mrs., h Meadow, Florence

- Freeman Henry, teamster, h River Meadows
 Freeman Julius, farmer N L Hospital, h Prospect
 Freeman Mellen J., broom maker, h 20 Washington av
 French Dexter W., conductor C R R R., h 7 Hawley
 French John LL. D., rem to Penn Yan, Pa
 French M. M., (M. M. French & Co.), h 16 Pomeroy Terrace
FRENCH M. M. & CO., clothiers aud gents' furnishings, 82 Main.
 [See p 253.]
 Frink Charles, emp B Bros & Co., h 21 Hawley
 Frole William Mrs., h High, Bay State
 Frost Edmund, emp W Mfg Co., bds 8 Fruit
 Frost Joseph, emp Amos Sawyer, bds Locust, Florence
 Frost Thomas, tailor L. E. Jacobson & Co., h Main, Bay State
 Fruin J. Mrs., h Bank av n King
 Fuller D. L., agent Wheeler & Wilson Mfg Co. 13 Pleasant, h Kirk-
 land av
 Fuller Henry L., mechanic, h Lilly n N Main, Florence
 Fuller J. Duane, clerk J. M. Towne & Sons, bds 11 Franklin
 Fuller Mary A. Miss, librarian, Florence Branch Library, h Maple, F
 Fuller Myra L., teacher, bds 17 Center
 Fuller Stephen B., insurance agent, h N Main, Florence
 Fulton William, mechanic F Mach Co., h 11 High, Florence
 Furner George, farmer, h North Farms
 Furth Rodolphus, barber 29 Maple, h 24 do, Florence
 Furth Rodolphus Jr., barber, bds 24 Maple, Florence
- GABB CHARLES N.**, Cigar manufacturer and tobacconist, 121
 Main, h 31 South. [See p 283.]
 Gabb George D., rem to Bloomfield, Ct
 Gagle Fred., emp Cotton Mill, h Nonotuck, Florence
 Gallivan Robert H., supervisor N L Hospital, bds do
 Gallivan Patrick, gardener, h West n iron bridge
 Gallond Lyman W., driver American Express Co., bds 5 River
 Galpin Chester L., section master N H & N R R, h River n gas works
 Gamwell Herbert, emp W Mfg Co., h 12 Olive
 Ganley Thomas, bds Main, Leeds
 Garceau Gideon, carpenter, h r 16 Walnut
 Gardner Ambrose H., brush maker, h 32 Vernon
 Gardner A. S. Mrs., h Center av
 Gardner Lucy B., widow Bela, h N Main, Florence
 Gardner David D., emp F Mach Co., bds 5 Main, Florence
 Gardner William B., clerk E. A. Brooks, bds 6 North
 Garcero Gideon, carpenter, h r 16 Walnut
 Gare Stowel, farmer, h North Prospect
 Garvey Michael, emp C R R R, h King
 Garvey Patrick D., laborer, h Prospect c Lawn av
 Garvey Patrick H., emp Maynard & Kimball, bds 37 Center
 Garvey Elizabeth, widow Thomas, h King
 Gawith Fannie W. Miss, instructor Clarke Institution for Deaf Mutes,
 Round Hill, bds do
 Gay George, emp B Bros & Co., bds 23 Hawley

FANCY PRINTING

BOOK PRINTING

Established in 1786

Gazette Printing Company

Northampton, Mass.

POSTER PRINTING

NEAT PRINTING

FANCY PRINTING
BOOK PRINTING

Established in 1786

Gazette Printing Company

Northampton, Mass.

POSTER PRINTING

NEAT PRINTING

- Gay Moses S., (Bridgman & Gay), bds 10 Phillips Place
 Gaylord Albert P., student, bds Maple, Florence
 Gaylord Edward E., physician, Maple, Florence, h do
 Gaylord William M., iron mfg, h 20 Pomeroy Terrace
GAZETTE PRINTING CO., job printers, (George L. Harris,
 George S. Gere,) Gothic r Savings Bank. [See opposite page.]
 Geary James, h Water, Florence
 Geittenby William, emp E Paper Co., h Loudville
 Gendrin Alexander J., casket maker, h 57 N Maple, Florence
 Georgie Edward, laborer, h Bridge road, c N Prospect
 Gere Edward C., printer, emp HAMPSHIRE GAZETTE, h High
 Gere George S., (GAZETTE PRINTING CO.), rooms 34 Gothic
GERE HENRY S., proprietor HAMPSHIRE GAZETTE, h 15 Maple.
 [See p 230.]
 Gerhard William, saloon, Maple, Florence, h do
 German Henry, emp N Silk Co., bds Water, Leeds
GERMANIA SINGING SOCIETY CLUB HOUSE, John
 Bernhardt, manager, Court c King. [See p 284.]
GEROU HENRY, carpenter, Water, Leeds, h do. [See p 269.]
G
 Gerrin see Guerin.
 Gerry James, laborer, h Water, Florence.
 Gerry Mary, widow John, h Water, Florence
 Gergoine, emp Brass Shop, Haydenville, h Reservoir road, Leeds
 Gibbs Dwight, lumber dealer, h 29 Pleasant
 Giebenheim George, boot and shoe maker, 16 Main, h Locust, Florence
 Gilbert Antony, laborer N Cutlery Co., h 52 Williams
 Gilbert Ellen M., widow William, h Vernon, Bay State
 Gilbert Lucy A., female supervisor N L Hospital, bds do
 Gilbert Raphael, cutler N Cutlery Co., h Hinckley c Warner, B State
 Gilbert Susan Mrs., attendant N. L. Hospital, bds do
 Giles Frank H., rem to Springfield
 Gilfillan Thomas, physician 104 Main, h 1 River
 Gilman Orlando W., foreman C R L Co. Mills, bds Mt Tom
 Gilmartin Mary, widow William, h Prospect n Franklin
 Gilmartin Thomas, laborer, bds Prospect n Franklin
 Gilmartin William, laborer, bds Prospect n Franklin
 Gill Laura D., teacher classical school for girls, bds Prospect
 Gillen Michael, laborer, h Prospect, Florence
 Glacken Michael, tailor, emp Merritt Clark & Co., bds Kirkland av
 Gladden Fred M., emp Tack Shop, bds 24 Maple, Florence
 Gladden Theo., farmer, h 24 Maple, Florence
 Gladden Theo E., traveling salesman, h 36 Bridge
 Gleason Ellen, widow Phillip, h 62 Prospect
 Gleason James, cutler, bds 62 Prospect
 Gleason Michael, rem to New Haven
 Gleason Patrick, teamster, h N King
 Gleason Phillip, blacksmith, rem to Worcester
 Gober Gustave, farm hand, bds Reservoir road, Leeds
 Gober Gustave A., emp W Mfg Co., bds Smith
 Godbout James, emp Brass Shop, Haydenville, h Chesterfield road,
 Leeds

- Goddu Francis X., rem to Canada
 Goddu George, emp B Bros & Co., bds Hockanum road
 Goddu Olive, widow Joseph, h 10 Masonic
 Godfrey Hannah C., widow William A., bds 167 Main
 Godfrey William, stone cutter, h Prospect c Winter
 Goodchild Alfred, shoemaker, h 14 Market
 Goodchild Henry, shoemaker, emp H. H. Baker, h Bates
 Goodell Andrew S., butcher emp M. W. Jackson, h 38 King
 Goodell Dexter W., pattern maker F Machine Co., h 16 High, F
 Goodell Ralph, Town Farm
 Goodman Sarah H. Mrs., bds 12 Prospect, Florence
 Goodrich David H., teamster N. Day & Co., h South n Brick yard
 Goodrich Harriet Miss, bds 15 Elm
 Goodrich Lillian C., Miss, attendant Shady Lawn, bds do
 Goodsell Michael, blacksmith emp W. Herrick, h 8 Cherry
 Goodwin Albert F., machinist, bds 46 N Maple, Florence
 Goodwin Edward B. (E. B. & W. C. Goodwin), h 46 N Maple, F
 Goodwin E. B. & W. C. (Edward B. & Walter C.), coal and wood, 48
 N Maple c Myrtle, Florence
 Goodwin James, emp Clement Mfg Co., h Main, Bay State
 Goodwin Walter C., carpenter, box manufacturer, &c.. (E. B. & W.
 C. Goodwin), 48 N Maple c Myrtle, Florence, h do
 Gomon Joseph, carpenter, h 38 Williams
 Gonyan Peter, emp Graves Bros., Maple, Florence
 Gordon John, emp N Silk Co., h Maple n Center, Florence
 Gorey Edward W., attendant Shady Lawn, bds Gothic
 Gorham Daniel D., principal high school, h 13 West
 Gorham Robert S., student, bds 13 West
 Gorman James, bds off Meadow, Florence
 Gorman John, emp cotton mill, bds Landy av c Nonotuck, Florence
 Gorman John, laborer, h Mill Yard
 Gouch Early, painter, emp C. H. Jones
 Gouch Francis, h Vernon
 Gouch Wilbur, laborer, bds Vernon
 Gould Alfred M., farmer, N. King
 Gould Asa B., laborer, h Prospect ab Massasoit
 Gould Charles E., supt wood dept F Mach Co., h Maple, Florence
 Gould Fred, emp B Bros & Co., bds r 24 Hawley
 Gould George M., farmer, bds N King
 Gould Grace Mrs., bds Prospect n Hinckley
 Gould Lewis H., painter, h Prospect n Hinckley
 Gould Nathan P., farmer, h N King
 Gould Sarah L., widow Solon, h Smiths Ferry
 Goyette Celeste, attendant N L Hospital
 Goyette Philomene, attendant N L Hospital
 Grady Patrick, laborer, bds 11 State
 Graff Charles, tailor, rem to New York
 Graham Joseph, farmer, h N King c Bridge road
 Granger Charles M., emp N Emery W Co., bds Center c Chestnut,
 Leeds
 Granger George, emp N Emery W Co., bds Water, Leeds

- Granger James C., silk dyer, bds N Main, Florence
 Granger Paul L., wheelwright B. M. Couch, h N Main, Florence
 Granger Rhoda Miss, h W Center, Florence
 Granger Sally Miss, h W Center, Florence
 Grant Oscar W., pattern maker B. M. Couch, bds Florence Hotel, F
 Grantier Delphine G. Mrs., emp F Mfg Co., bds Main, Florence
 Gratton Eli, rem to Canada
 Graves Arthur S., clerk M. W. Jackson, h 9 Massasoit
 Graves Augustus B., farmer, bds 93 Bridge
 Graves, carpenter, bds North
 Graves Bros., (George S. & Edward E. Graves), livery stable, Maple,
 Florence
 Graves Cyrus M., h 17 Washington av
 Graves Clarence K., clerk 106 Main, bds Masonic c Center
 Graves C. L., farmer, h Maple, Florence
 Graves Dwight A. (Graves & Cooley), h 17 High
 Graves Edward E. (Graves Bros.), h W Center, Florence
 Graves Edwin M., clerk R. M. Branch, h Pine n Main, Florence
 Graves Electa Mrs., bds 78 Bridge
 Graves Emma Mrs., bds 2 Phillips Place
 Graves Erastus L., carpenter, h 14 Franklin
 Graves Frank, silk worker N Silk Co., bds Park, Florence
 Graves George S. (Graves Bros.), h W Center, Florence
 Graves Herbert R., clerk M. L. & M. W. Graves, bds 17 Washington av
 Graves Henry B. (Graves & Tucker), h 11 Union
 Graves Irving R., farmer, h 80 Bridge
 Graves Israel A., livery stable Maple, h Main c Maple, Florence
 Graves Jno. B., farmer, h 48 Bridge
 Graves Josiah S., farmer, h 82 Bridge
 Graves Louis B. (Geo. S. Whitbeck & Co.), rooms 124 Main
 Graves Lucius C., book-keeper First Nat'l Bank, bds Masonic c Center
 Graves Lyman, farmer, h 58 N Maple, Florence
 Graves Maria E., attendant N L Hospital
 Graves Martin B., farmer, h 91 Bridge
 Graves Mary O. Mrs., h Park, Florence
GRAVES M. L. & M. W., (Melvin L., Myron W.) flour, grain
 and grist mill, R R Steam Mill, Main c Market. [See p 258.]
 Graves Myron W. (M. L. & M. W. Graves), h 31 West
 Graves Melvin L. (M. L. & M. W. Graves), h 16 Washington av
 Graves Newell, emp C. E. Gould, h 29 Center, Florence
 Graves Noah F., night watchman B Bros & Co., h Center av
 Graves Porter Mrs., h N Farms
 Graves Robert B., broom handle painter, h 93 Bridge
 Graves Sylvanus P., farmer, h N Farms
 Graves Thomas, gardener, h 91 State
 Graves & Cooley (Dwight A. Graves, Silas R. Cooley), tobacco dealers,
 Strong av., opp Conn R.R. depot
 Graves & Tucker (H. B. Graves, George Tucker), wholesale tobacco,
 Main opp Canal R R depot
 Gray John, driver O. Edwards & Co., bds Elm c Prospect
 Gray Robert, emp Clement Cutlery Co., bds Warner, Bay State

GREAT AMERICAN CLOTHING STORE, A Sherwin, prop'r,
18 Main. [See outside front cover.]

Green Albert, emp N Street Railway, h 41 Bridge

Green Albert J., bread peddler, h N Main, Florence

Green Arthur S., driver N St R R Co., 41 Bridge

Green Nicholas, teamster emp Kimball & Cary, rooms Crafts av

Green Thomas, emp Button Co., h 6 Warner Row, Leeds

GREENVILLE MFG. CO., cotton goods mfg, junc Nonotuck and
River, Florence. [See p 240.]

Greenwood Ambrose, emp M R B Co., h Leonard n Front, Leeds

Greenwood Gedio, emp Button Shop, bds Leonard n Front, Leeds

Greiner Christopher, tailor, h 11 Green

Grennan Michael, farmer, h Spring, Leeds

Grennan Thomas, emp M R B Co., bds Spring, Leeds

Grennan William, sawyer M R B Co., bds Spring, Leeds

Griffin Catharine Miss, h Elm n junc N Elm

Griffin James C., boarding House 33 Pleasant, h do

Griffin Jerry, laborer, h Hinckley

Griffin John, clerk 100 Main, bds Prospect

Griffin Kate Miss, h Elm n N Elm

Griffin Naomi Mrs., attendant N L Hospital, bds do

Griffin Thomas, emp N Paper Co., h 35 Prospect

Griffin Thomas Jr., rem to Troy, N Y

Griffin Thomas R., tinner, emp Lee & Day, bds 177 Main

Griffin Timothy, tailor, emp Merritt Clark & Co., h 70 Bridge

Griswold Sophie W., clerk H Mutual Fire Ins Co., bds 17 Pleasant

Grogan Matthew, tailor emp Merritt Clark & Co., h King

Grogan William, bds King

Guerin Eustace, emp W Mfg Co., bds 12 Main

Guerin John, emp W Mfg Co., h 24 Williams

Guerin Victoria, widow Eric, h 15 State

Guerin see Gerrin

Guilfoile John B., driver Norwood Ice Co., bds 177 Main

Guilfoile Mary, widow John, h Prospect c Lawn av

Guilfoile Minnie, attendant N L Hospital

Guilfoile Thomas H., clerk Florence House, bds do

Guilfoile Timothy, farmer, h Pine Grove

Guilford Austin, carpenter, h N Farms

Guilford Frank F., farmer, bds N Farms

Guilford Julius S., h Masonic

GUILFORD R. M. & CO., (Ralph M. Guilford, Frank H. War-
ren) livery stable, Pearl c Strong av. [See p 280.]

Guilford Ralph M. (R. M. Guilford & Co.), h Center

Guilford Wallace, farmer, bds N Farms

Guinan Eliza, widow James, h r Masonic

Guinan Frank H., conductor N St R R, bds r Masonic

Guinan William H., clerk R Lewis & Son, 193 Main, bds r Masonic

Gulow William, cutler N Cutlery Co., Main, Bay State

Gunn Carrie Miss, 17 Washington av

Gunyan Fanny Mrs., emp L. J. Warner, bds Elm n Silk Mill

Gunyan Mary, emp L. J. Warner, bds Elm n Silk Mill

Guy Herbert E., rem to Ware, Mass

HABERLIN STACIA, emp G Mfg Co., h Nonotuck, Florence
Hackett Michael, cutler N Cutlery Co., h Maple, Bay State
Hadley Stephen D., (S. D. Hadley & Co.), bds 36 Bridge
HADLEY S. D. & CO., (Stephen D. Hadley, Richard A. Cowing)
 H boot and shoe dealers 98 Main. [See p 257.]
Hafner Charles, bologna maker, h 5 Pleasant
Hafner Charles Jr., emp B Bros & Co., bds 5 Pleasant
Hagenlock Charles, emp N Cutlery Co., h Arlington
Hager Isaac N., flour dealer Main c Hawley, h Myrtle n King
Hahn Hermann, emp B Bros & Co., bds 18 Market
Hale Melvin M., emp Button Co., h Leonard, Leeds
Hale Wm. B., pres First Nat'l Bank of Northampton, res Springfield,
 Mass
Haley Dolay, widow Martin, h Bridge road at N Prospect
Haley George, butcher, bds Bridge road, Florence
Haley James, mechanic, F Mach Co., bds Nonotuck, Florence
Haley John 2d, emp F Mach Co., bds Nonotuck, Florence
Haley John, emp G Mfg Co., bds River, Florence
Haley John, saloon Nonotuck, Florence, h do
Haley Martin, hostler R. M. Guilford & Co., bds Nonotuck House
Haley Michael, h Nonotuck, Florence
Haley Patrick, mechanic G Mfg Co., h River, Florence
Hall Allen J. Rev., pastor M. E. Church, Florence, h N Main, F
Hall Arathusa Miss, Elm c Paradise road
Hall David G., 2nd assist physician N L Hospital, bds do
Hall Edward P., (E. P. Hall & Co.), h 24 Gothic
HALL EDWARD P. & CO., (Edward P. Hall, Edwin H. Ban-
 nister,) lumber, Gothic n Court, r Gazette office. [See p 267.]
Hall Ellen, widow John, h Water, Florence
Hall Erastus C., farmer, h 37 South
Hall Fred, mechanic F Mach Co., bds 36 Main, Florence
Hall John, laborer, h Lake, Florence
Hall John, laborer, h Prospect c Spring
Hall John L., teamster Kimball & Cary, h Prospect
Hall Mary Mrs., waiter N L Hospital, bds do
Hall Patrick, emp E. N. Foote & Co., bds 74 Pleasant
Hall William, laborer, h Lake, Florence
Hall William C., assistant engineer N L Hospital, bds do
Hall William J., mechanic, h 23 Pleasant
Hallett Henry C., supt B Bros & Co., h 12 Hawley
Halloran John, emp Clement Mfg Co., bds Federal, Bay State
Halloran Margaret, widow Michael, h Bridge road
Halloran Michael, emp N Cutlery Co., bds Federal, Bay State
Halloran Patrick, laborer, h Federal, Bay State
Halpine Jeremiah, emp F Mfg Co., h Spring, Florence
Hamilton Emma L. Miss, teacher Grammar School No. 4, bds 10 South
Hamilton Luther W., carriage painter, King c Court, h do
Hamilton Philip, farmer, h West, Leeds
Hamlin Arthur G., attorney-at-law, clerk District Court, 46 Main, bds
 74 Elm
Hamlin Elmer E., bds 74 Elm

Hammond Charles Mrs., h 17 King

HAMMOND JOHN C., attorney-at-law over First National Bank,
h 10 King. [See p 242.]

Hammond John F., mason, bds N Elm

Hammond Julia A., widow Salem, h 10 King

Hampshire County Jail and House of Correction, Union

HAMPSHIRE COUNTY JOURNAL, (Weekly,) Wade, Warner
& Co., Jones blk, Court. [See p 231.]

HAMPSHIRE COUNTY NATIONAL BANK, 112 Main. [See
p 229.]

HAMPSHIRE DAILY & WEEKLY HERALD, Bridgman &
Gay proprietors, Jones blk, Court. [See p 232.]

HAMPSHIRE GAZETTE, (Weekly,) Henry S. Gere, Gothic, r
Savings Bank. [See p 230.]

HAMPSHIRE HOUSE, Geo. R. Whipple proprietor, Main c
Strong av. (See p 277.)

Hampshire Law Library, Court House

HAMPSHIRE MARBLE WORKS, C. W. Kinney, proprietor,
Court c King. [See p 272.]

HAMPSHIRE MUTUAL FIRE INS CO., Kirkland's block,
52 Main. [See p 245.]

HAMPSHIRE SAVINGS BANK, 112 Main. [See p 226.]

HAMPSHIRE STEAM DYE HOUSE, F. W. Kaiser proprietor,
7 State. [See p 278.]

Hancock Andrew P., printer emp **GAZETTE PRINTING CO.**, h Kirk-
land av

Hancock Clarissa Mrs., h Kirkland av

Hancock William, upholsterer emp Searle & Edwards

Handrahan Martin Mrs., h Gothic

Handrahan Martin, mason, bds Nonotuck House

Haney Charles W., machinist, h Center av

Haney Daniel, emp L. W. Smith, bds Nonotuck House

Haney Martha R., attendant N L Hospital

Hanley Alice, widow Thomas, h N King

Hanley John, shoemaker 5 Pleasant, h Bates

Hanley Patrick, G Mfg Co., h River, Florence

Hannah John, h 36 Market

Hannan Edmund, emp G Mfg Co., bds 23 River, Florence

Hannigan Michael, moulder, h Spring, Leeds

Hannum George H., mason and builder, h Franklin

Hannum John F., mason, bds N Elm

Hannum S. W., eng Washington

Hardie James H., (Hardie & Schadee,) h Myrtle c State

Hardie & Schadee, (James H. Hardie, Ferdinand Schadee,) photo-
graphers, 105 Main

Harding E. B. Mrs., h 20 Pleasant

Harding Henry, emp A. Sawyer, h Locust, Florence

Hardy William H. Mrs., h 6 Summer

Hardyman Martin, teamster, bds 77 Elm

Hargaden Timothy J., barber, emp E. F. Wallace 181 Main, bds
Masonic

- Hargrave Benjamin, emp W Mfg Co., h Massasoit
 Harley Cornelius O., machinist N Silk Co., h Center, Leeds
 Harlow Charles N., (C. N. Harlow & Co.,) h Pleasant n C R R crossing
HARLOW CHARLES N. & CO., (Charles N. Harlow, George W. Harlow,) carpenters and builders, Kirkland av. [See p 268.]
 Harlow George W., (C. N. Harlow & Co.), carpenter, h 10 Maple
 Harlow Ozro F., carpenter, h 28 Walnut
 Harlow William E., emp Charles N. Harlow & Co., bds Masonic
 Harney Johanna, h Prospect ab Franklin
 Harntxeus Doneat, emp N Cutlery Co., h Main, Bay State
 Harrington Catherine H. Mrs., milliner and dressmaking, Main n Nonotuck, Leeds, h do
 Harrington George F., farmer, h 79 Bridge
 Harrington Thaddeus W., bridge builder, h 29 West
 Harris Charles E., emp B Bros & Co., h 13 Market
 Harris Charles M., mechanic F Mach Co., h Chestnut ab High, F
 Harris E. M. Miss, dressmaker 5 Market, bds do
 Harris George L., (GAZETTE PRINTING Co.), office Gothic r Savings Bank, h State n Park
 Harrison Joseph, emp W Mfg Co., h Olive
 Hart Edward E., groceries, dry goods, boots, shoes, &c., Main, Bay State, h Main c Maple do
 Hart Henry, h 203 Main
 Hart L. R., confectioner and restaurant 203 Main
 Hart Peter, emp Damon Narrow Fabric Co., h 17 Gothic
 Hart Walter S., emp F Mach Co., h Water, Florence
 Hart William H., porter, rooms Main, Bay State
 Harten Franz, emp B Bros & Co., bds 24 Hawley
 Hartford William, machinist N Silk Co., bds Center, Leeds
 Harting Henry, teamster, h N Elm opp Spring
 Hartney John, emp N Cutlery Co., h Main, Bay State
 Hartung John, h 3 Washington av
 Hartwell George, yeast peddler, bds 23 Pleasant
 Hartwell James L., conductor, h 20 Elm
 Hartwell Tryphena Miss, h 16 Green
 Hartwell Warren S., blacksmith 27 Maple, Florence, h do.
 Harty Patrick, cook Mansion House, h Summer
 Harvey Edward S., emp L. W. Smith, h Prospect
 Harvey Sarah, widow Stephen, rem to Springfield
 Hasson Ann, widow William, h High, Bay State
 Hastings Clarissa, widow Ozius, W Farms
 Hastings Ephraim, h 23 Market
 Hastings Leonard G., carpenter, h 17 High, Florence
 Hathaway Alphonso E., jeweller Mansion House Block 133 Main, h 8 Walnut
HATHAWAY JASPER J., pencil mfr 83 South, h 23 Cherry. [See p 239.]
 Haug Martin, emp N Cutlery Co., h Main, Bay State
 Haughton Elizabeth Miss, h 17 Spring
 Haughton Rebecca Miss, h 17 Spring
 Haughton Richard, machinist h 51 South

Haunton Horace, paper maker C Loud, h Loudville
 Haunton Thomas, millwright emp W & C., h Loudville
 Haven Carrie T. Miss, teacher Kindergarten school, bds Pine, Florence
 Haven Henry B., treas and manager F Furn Co., h 20 Park, Florence
 Haven Sarah H., widow Wm. T., h Pine, Florence
 Hawes Eliza E., Mrs., clerk 86 Main, h 28 Main
 Hawes Winnie E. Miss, clerk 86 Main, bds 28 Main
 Hawkes Charles, apprentice W. F. Prindle, bds 82 South
 Hawkes James R., attendant Shady Lawn, bds do
 Hawkins Albert, painter, h 60 Bridge
 Hawker Henry C., emp Forbes & Wallace, Springfield, bds 14 River
 Hawker William, cloth dresser, h 14 River
 Hawksley Edward B., emp N Silk Co., bds 8 Prospect, Florence
 Hawksley George, emp N Silk Co., h 8 Prospect, Florence
 Hawksley John W., emp N Silk Co., bds 8 Prospect, Florence
 Hayden Joel, manufacturer, h 5 Bridge c Hawley
 Hayes Jeremiah, farmer, h North King
 Hayes John, emp B. M. Couch, h River, Florence
 Hayes Kate Miss, bds N King
 Hayes Margaret, widow Daniel, h Rust's blk South
 Hayes Margaret A. Miss, dressmaker 22 Main, bds King
 Hayes Nicholas G., (Hayes & Burby), h 12 Walnut
 Hayes William, laborer, h Lawn av
 Hayes & Burby, (Nicholas G. Hayes, James D. Burby), harness makers
 103 Main
 Hayner Rosie E. Mrs., clerk Cutler, Plimpton & Co., h 17 Pine F
 Hazen James O., painter 7 Masonic, h State n Center
 Heald Charles H., carpenter, h 20 Summer
 Healy Dennis, farmer, h Bridge road n Cemetery
 Hearn Michael, farmer, h Florence, Leeds
 Hearn Patrick, emp M R B Co., h Water, Leeds
 Hearn Thomas, emp F Mach Co., h Spring, Florence
 Heavy John, laborer, bds South, Florence
 Hebert Antony, shoemaker 140 Main, h Masonic
 Hebert Boswell, (B. Hebert & Son,) h 39 Bridge
HEBERT B. & SON., (Boswell Hebert, Joseph Hebert), carpen-
 ters & builders, Bridge opp Cemetery. [See p 270.]
 Hebert John, tinner, emp W. F. Prindle, bds 39 Bridge
 Hebert John, emp C. A. Maynard, h 8 Market
HEBERT JOSEPH, carpenter Gothic n Court, h 14 Cherry. [See
 p 268.]
 Hebert Joseph, (B. Hebert & Son) h 21 Cherry
 Hebert Joseph Oliver, emp W Mfg Co., h 32 Williams
 Hebert Louis, broom maker, h r 16 Walnut
 Hebert Margaret, widow Joseph, bds r 16 Walnut
 Hebert Nelson, broom maker, h 68 Pleasant
 Hebert Nelson Jr., meat market Main, h do, Leeds
 Hebert Samuel, sawyer M R B Co., h Main, Leeds
 Hebert see Hibbard
 Heffernan George D., waiter R. M. Welch 128 Main, rooms King
 Heffernan James, carpenter, h West, Florence

- Heffernan John, emp L. W. Smith, h King
 Heffernan John, emp M R B Co., h Floreuce, Leeds
 Heffernan Michael, rem to Holyoke
 Hefner see Hafner
 Hellman Jacob, loom fixer B Bros & Co., bds 22 Market
 Henchey Dennis, farmer, h Franklin
 Henchey Dennis, emp A. Sawyer, h Cemetery road
 Henchey Dennis Jr., grinder, bds Cemetery road
 Henchey Michael, laborer, bds Franklin
 Henchey Patrick, farmer, h Cemetery road
 Henchey Thomas, farmer, h N Prospect at R R crossing
 Henchey Thomas N., boss etcher N Cutlery Co., h N Prospect
 Henchey William, cutler, bds Cemetery road
 Henderson Elizabeth, widow John D., h State n Center
 Henderson Walter B., clerk Ins Office C. H. Pierce, bds State n Center
 Hennerbury Annie, domestic, Beacon, Florence
 Hennessey John, emp M R B Co., h Water, Leeds
 Hennessey John, h West, Florence
 Hennessey John Jr., mechanic F Mfg Co., h South, Florence
 Hennessey Michael, laborer L Bodman, bds Elm
 Hennessey Michael J., cutter Merritt Clark & Co., bds Kirkland av
 Hennessey William, emp F Mfg Co., bds South, Florence
 Hemenway Dwight A., h Meadow c Lilly, Florence
 Hemenway Henry H., gardener L Clark Seelye, h Factory
 Hemenway Hubbard H., emp N Paper Co., h Mill, Bay State
 Hemenway James, farmer, h Roberts Meadow
 Hemenway S. S. Mrs., h 43 Main, Florence
 Herlihy Daniel, clerk O'Donnel & Herlihy, h Water, Florence
 Herlihy Thomas, (O'Donnell & Herlihy), h Water, Florence
 Herrick Charles E., foreman W. Herrick, h 8 Green
HERRICK WEBSTER, manufacturing machinist, shop between
 Pleasant and R R av, h King. [See p 239.]
 Hersey Heloise E. Miss, teacher Rhetoric Smith College, bds Hatfield
 House
 Hervey Edwin T., janitor Court House, h 4 River
 Herzinger Charles, joiner, h Gothic
 Hesse Fanny C. Miss, matron Hatfield House, Smith College
 Hibbard Joseph J., laborer, h Main, Bay State
 Hibbard Nelson, broom maker emp H. E. Smith, h Pleasant
 Hibbard see Hebert
 Hibschnann Edward, emp B Bros & Co., h 24 Hawley
 Hickey Bridget, widow James, h N Prospect
 Hickey Charles, emp N Cutlery Co., h Vernon, Bay State
 Hickey James, laborer, h ab Bridge road
 Hickey James T., overseer N Silk Co., h Pine, Florence
 Hickey John, bds Loudville
 Hickey Mary, widow William, h Gothic
 Hickey Michael laborer, h Nonotuck, Florence
 Hickey Michael, bds N Prospect
 Hickey Patrick, laborer, emp S. Carr, h 15 State
 Hickey William, laborer, h West, Florence

Higbee Edwin W., physician 112 Main, rooms do
 Higgins Bartlett, horse shoer, emp V. Francis, bds 12 Market
 Higgins Gordon W., clerk H. H. Baker, 60 Main, h 7 Walnut
 Higgins James, laborer, bds n Cemetery road
 Higgins John, teamster, h Bridge road c Oak, Florence
 High School, Main n West
 Hill Albert, emp N Cutlery Co., h Main, Bay State
 Hill Alexander, teamster Brown & Bailey, h Mill Yard
 Hill Anna Mrs., bds Main, Bay State
 Hill Arthur G., assistant treas N. Silk Co., h 13 Maple, Florence
 Hill Charles L., cutler C Cutlery Co., h Warner, Bay State
 Hill David (Hill & Wainwright), attorney-at-law, N Inst for Savings
 bdg, Main, res Prospect, Easthampton
 Hill Edward, bds Allen
 Hill Henry, cutler N Cutlery Co., h Main, Bay State
 Hill Ruth Miss, h N Farms
HILL & WAINWRIGHT, (David Hill, J. Arthur Wainwright),
 attorneys at law, over N I for Savings, Main. [See p 243.]
 Hildreth Susan M., widow Fred., h 1 Clark av
 Hillenbrand Fred C., cutler N Cutlery Co., h High, Bay State
 Hillenbrand George, cutler N Cutlery Co., h High, Bay State
 Hillman Arad, h Washington av
 Hillman Frank R. Mrs., bds Masonic
 Hillman George M., clerk G. L. Loomis & Co., bds 6 North
 Hillman James W., watchman C R R R, h 7 Walnut
 Hillman Jerome E., clerk G. L. Loomis & Co., h 9 Franklin
 Hillman John R., baggage master N H & N depot, h 6 North
 Hillyer George, emp F Tack Co., bds Holyoke, Florence
 Hillyer William, night watchman F Tack Co., h Holyoke, Florence
 Hilton Herbert C., emp Shumway & Riley, bds High, n R R, Florence
 Hinckley Henry R., pres N Cutlery Co., h Prospect
 Hinckley Nellie, emp N Silk Co., bds Lilly n N Main, Florence
 Hitchcock Charles, rem to Holyoke
 Hitchcock George F., clerk Am Express Co., h 21 Fort
 Hitchcock Lewis F., wood turner, emp W. C. Pomeroy, h 44 Market
 Hitchcock Martha, widow Frank, bds 21 Fort
 Hixon Mary Miss, waiter, Mansion House
 Hoadley George A., principal high school, h Park, Florence
 Hobson James, joiner, h Oak, Florence
 Hodgson Charles, cutler N Cutlery Co., h Main, Bay State
 Hoffman George V. S., supt Northampton Paper Co., h Vernon, Bay
 State
 Hoffman William J., rem to New York
 Hogan Bridget, emp G Mfg Co., bds 30 Maple, Florence
 Hogan Hannah, emp F Mfg Co., h Park, Florence
 Hogan James, hostler Dickinson & Pomeroy, h Prospect
 Hogan John, emp F Machine Co., bds Park, Florence
 Holahan Margaret Mrs., h Cemetery road
 Holahan Mary, bds Hospital Hill c West
 Holcomb Fred C., harness maker emp Hayes & Burby, rooms West,
 n R R

Holcomb Hiram L., machinist F Mfg Co., h Park c Bridge, Florence
 Holcomb Joseph, emp Day Bros., h 104 South

Holbrook Horace, emp Clapp & Johnson, h State n Spring
 Hollohan Michael, emp Bay State Cutlery Co., h Spring, Florence

HOLLEY HENRY G., livery stable 206 Main, opp Masonic, h do
 [See p 282.]

Holley Jacob, h 206 Main

Holliday Harriet, attendant N. L. Hospital

Holliday William R millwright, h Main, Bay State

Holliday William T., mechanic, bds Main, Bay State

Holmes Almira, widow Charles, bds 52 Main

Holmes Geo. W. Mrs., h Masonic

HOLMES NORMAN, manager C. N. Stimpson, h 52 Main. [See
 front cover.]

Holmes Thomas J., dyer, h 8 Summer

Holmes Thomas J. Jr., dyer 10 Summer

Holzman Jacob, treas N Pocket Book Co., bds 17 Market

Hopkins E. J. Mrs., housekeeper Dewey House, Smith College

Hopkins Isabella T. Miss, bds 44 Elm

Hopkins James H., emp G Mfg Co., bds N Main, Florence

Hopkins James M., traveling agent, h N Main, Florence

Hoppin Ruth Miss, teacher Biology Smith College, bds Washburn
 House

Horan John, laborer, h Spring c State

Horstman Carl, cigar maker emp T. J. Slattery, bds 177 Main

Horton Dwight A., fertilizers, Steam Mill, Main, res Hadley

Horton Everett, C R L Co., boarding House, Mt. Tom

Horton Julius O., overseer B Bros & Co., bds 45 Pleasant

HOSMER PHINEAS P., boots and shoes, 189 Main. [See p 257.]

HOTCHKISS WALES, artist 38 Main, rooms do. [See p 246.]

Hough Esther Miss, emp N Silk Co., bds N Main, Florence

Hough Theo E., contractor F Mach Co., h 12 Center, Florence

Houghton Aldorus A., bds Nonotuck House, Pleasant c Pearl

Houston Edgar A., rem to Dalton, Mass

Houston Joseph E., farmer, h Smiths Ferry

Houston Samuel R., boarding house, 30 Maple c River, Florence

Howard Edward, laborer, bds 42 South

Howard Fred W., emp B Bros & Co., h Franklin n Prospect

Howard John L., attendant N L Hospital, bds do

Howard Joseph, sawyer M R B Co., h Chesterfield road, Leeds

HOWARD MYRON C., painter, W Center, h do Florence. [See
 p 250.]

Howard W. S., overseer N Silk Co., bds Chesterfield road, Leeds

Howarth Jeremiah A., rem to New Haven, Ct

Howe George E., teamster, h Prospect n Spring

Howes Calvin, clerk A. McCallum, bds 34 King

Howes Delia C. Mrs., h 11 River

HOWES ELISHA B., truckman, 122 Main, h Maple, Florence.
 [See p 273.]

- Howes Elson B., gardener N L Hospital, bds do
 Howes Minnie J., laundress N L Hospital, bds do
 Howes Wilbur E., carpenter, bds 11 River
 Howes William H., box maker, emp A. Kingsbury & Son, rooms 38
 Main
 Howland Cornelia Miss, h 33 King
 Howland David B., local editor Hampshire Daily Herald, rooms 10
 Phillips Place
 Howland Frank, bds 33 King
HOXIE DAVID E., jeweler and Nurseryman, 60 Main, h 20
 Franklin. [See p 254.]
 Hoxie Hannah B., widow Benjamin, h Roberts Meadow
 Hubbard George W., Treas Smith College, 101 Main, rooms do
 Hubbard John W., market gardener, h 90 Bridge
 Hubbard Marshall Mrs., h 34 South
 Hubbard Oliver A., farmer, h W Farms
 Hubbard Roxanna H. Mrs., h 8 Green
 Hubbard Sanford G., farm hand, bds North
 Hubbard Wallace S., harness maker emp H. P. Smith, bds 35 South
 Hubschman Edward, silk weaver, h Hawley
 Hudson John, rem to Holyoke
 Hugerford Mary Mrs., h 5 Hawley
 Hughs Christopher, stone cutter, h State
 Hughs George, rem to Springfield
 Hulme Richard, engineer B. M. Couch, h Hickory, Florence
 Humphrey Carlos, shoe maker, 45 Main, Florence, h do
 Humphrey John N., h Locust, Florence
 Humphrey Minnie L., widow Herbert C., h 26 Main, Florence
 Hunt George H., clerk Clapp & Johnson, h 18 South
 Hunt Ira, emp C. A. Maynard, bds 8 Fruit
 Hunt Josiah T., emp N Emery Wheel Co., h Center n Chestnut av,
 Leeds
 Hunt Martin L., mechanic F Mach Co., h Water, Florence
 Hunter George, teamster, rem to Hadley
 Huntington J. M., compositor Hampshire Herald, bds 22 Market
 Huntley Leroy S., mechanic F Mach Co., h Fruit, Florence
 Huot George W., rem to Springfield
 Hurd E. A., millwright, h Grant av
 Hurlburt Adolphus, brick maker N. Day & Bros., h West n R R
 crossing
 Hurlburt Charles, laborer, h south n R R
 Hurlburt Helen M., widow Daniel B., h W Farms
 Hurlburt Otto, brick maker, h Hospital Hill
 Hurley Bridget, widow John, h Haydenville road, Leeds
 Hurley Charles, h off Hinckley, Bay State
 Hurley William, moulder F Mach Co., h Water, Florence
 Hurley William, laborer N H & N Co., h King
 Hussey Albert C. Rev., pastor Baptist Church, h 214 Main
 Hussey Martha S. Miss, teacher Elocution, 17 Elm, res Billerica
 Hussey N. B., rem to Minneapolis, Minn
 Hutchins Sarah L., widow Geo. G., nurse, h 21 Summer

Huxley Charles A., overseer N Silk Co., bds 18 Prospect, Florence
 Huxley Dwight S., machinist N Silk Co., bds 14 Main, Florence
HUXLEY JOHN, carpenter, 5 Arlington, h do. [See p 269.]

Huxley Joseph, foreman machine dept, N S Co., h 18 Prospect, F
 Hyde Charles L., fish market 20 Main, Florence, h High, Florence
 Hyde Sumner, mechanic, h 39 Center

INGRAHAM MARTHA MISS, bds 21 Summer
 Ingram Edward A., emp E. N. Foote & Co., h 175 Main
 Ingram James, driver John Parnell, bds Pleasant
 Ingram John, clerk John Parnell, bds Pleasant
 Ingram William, emp C R R R, h Pleasant n Williams
 Inman Elizabeth, widow Erastus, h 18 Market
 Irwin Abbie Miss, school teacher, bds Mansion House
 Irwin John A., rem to Boston
 Irwin Lizzie Miss, school teacher, bds Mansion House
 Irwin Sarah A. Mrs., rem to Wilbraham, Mass
 Ives Mary B., widow Daniel, h Park, Florence

JACKSON EARLE P., driver emp M. W. Jackson, bds 49 Market
 Jackson Edward, cook, h 30 State
 Jackson George, ice cream, &c., Elm n brick yard, h do
 Jackson George, laborer h Hospital Hill
 Jackson Jerome A., butcher emp M. W. Jackson, bds N Prospect c
 Cemetery road

JACKSON MERRILL W., meat market 126 Main, h 47 Market
 [See p 262.]

Jackson Michael, laborer, h Hinckley
 Jackson Patrick, cutler, h Hinckley
 Jacobson L. E. & Co., (Louis E. and Samuel,) clothiers and merchant
 tailors, Opera House blk, 118 Main
 Jacobson Louis E., (Jacobson & Co.,) h State c Bright
 Jacobson Samuel, (Jacobson & Co.,) h River
 Jacobus William, emp F. X. Menard, bds 191 Main
 Jager Christina, widow J., h Prospect c Locust
 Jager Fred, mechanic, bds Prospect c Locust
 Jager George, farmer, bds Prospect

JAGER JOHN C., carriage maker Maple, h Holyoke, Florence.
 [See p 276.]

Jager William, mechanic, bds Prospect c Locust
 Jaggard Edwin L. Rev., h 15 Elm
 James Henry L., rem to Williamsburg, Mass
 Janes Edward L., clerk, h 44 South
 Janes Samuel P., clerk, bds 44 South
 Janes Sarah, widow Samuel, h 44 South
 Jarvis Charles, grinder, h Warner, Bay State
 Jarvis Emma Mrs., h High, Bay State
 Jarvis Nicholas, h Cutlery blk, Bay State
 Jarvis Thomas, mason, rem to Holyoke

- Jarvis Victor, cutler, emp N S Co., h Cutlery blk, Bay State
 Jencks George A., mechanic F Mach Co., bds 50 Main, Florence
 Jencks George L., mechanic F Mach Co., h 50 Main, Florence
 Jencks Walter S., book keeper Hamp Co Nat'l Bank, bds 50 Main, F
 Jenkins Fannie R., widow William, h 37 Prospect
 Jenkins John R., farmer, Pine Grove
 Jenkins Luther, emp F Mach Co., h Chestnut ab High, Florence
 Jenkins William H., farmer, Pine Grove
 Jenner George W., emp N P B Co., h Lincoln av
 Jenney Henry A., mechanic, h High, Florence
 Jennings Roscoe L., clerk E. E. Hart, rooms High, Bay State
 Jennings W. H. H., teamster, h Bates
 Jepson Calista C., widow Forace, h 5 Clark av
 Jepson Rose C. Mrs., bds Masonic
 Jewell Sarah Miss, nurse, h Prospect c Spring
 Jewett Elizabeth, widow Ansel, h 45 Elm
 Jewett Elizabeth Miss. h 45 Elm
JEWETT, GEORGE D., wholesale lumber dealer 90 Main, h 45
 Elm. [See p 269.]
 Jewett Joseph, carpenter, h State ab Myrtle
 Jewett Mary Miss, h 45 Elm
 Johnson Edwin, emp W Mfg Co., bds 76 South
 Johnson George S., mechanic F Mach Co., h High, Florence
 Johnson Harry L., laborer, h Bates
 Johnson Herbert S., emp C R L Co., bds 76 South
 Johnson Horacé, h Haydenville Road, Leeds
 Johnson H. W., farmer, h Leeds
 Johnson Isabella S. Miss, h Hospital Hill
 Johnson Jesse, emp N E Wheel Co., bds River road, Leeds
 Johnson Lowell M., (Clapp & Johnson), h Bates u Lincoln av
 Johnson Mederic, rem to Hatfield
 Johnson Nelson G., carpenter, h 76 N Maple Florence
 Johnson Philip, overseer L. J. Warner, bds Elm n Silk Mill
 Johnson Sidney, h Haydenville Road, Leeds
 Jones Charles D., carpenter, emp N Paper Co., h Federal, Bay State
 Jones Charles H., painter Jones blk Court, h do
 Jones George Q., upholsterer, emp W. L. Smith & Co., h Gothic
 Jones Henry, music teacher, h Washington av
 Jones Owen, laborer, h 69 South
 Jones Simon W., painter, emp C. H. Jones, bds Jones blk, Court
JONES WILLIAM H., dentist Clarke blk 58 Main, h Paradise
 road. [See p 244.]
 Jordan Horatio, mechanic F Mach Co., h 9 Chestnut, Florence
 Joslyn Eliza Miss, h West Farms
 Joslyn Homer, carpenter, h Main, Bay State
 Joslyn Levi W., confectioner, h 85 Elm
 Joy George E., mail carrier, bds 16 Green
 Joy John P., (Landy Bros. & Co.), bds Nonotuck, Florence
 Joy Lorenzo W., postmaster, h 16 Green
 Joyce John, moulder, bds Center, Florence
 Joyce Peter, moulder, h Center, Florence

Joyce Thomas, laborer, h Kirkland av
 Joyce Thomas G., emp B Bros & Co., bds Kirkland av
 Judd Frances P., widow Hall, h 18 Park, Florence
 Judd Henry W., painter, h N Farms
 Judd Nina Miss, h Elm c Paradise Road
 Judd William, farmer, h N Farms

KAISER FREDERICK W., prop Hamp Steam Dye House, 7
 State, h do. [See p 278.]
 Kanava Michael, laborer, h Mill Yard
 Kanava Patrick Mrs., h N King
 Kane John, laborer, h Winter
 Kane Thomas, steward Mrs. M. K. Olney, bds 145 Main
 Kapp Marie F. Mrs., teacher German Smith College, bds Henshaw av
 Kathan Mary A., instructor C. I. D. Mutes, Round Hill, bds do
 Kato Charles, emp F Mfg Co., h Park opp W Center, Florence
 Keach John, clerk M. W. Jackson, h 15 West
 Kearney Elizabeth, widow Robert, bds Lincoln av
 Kearney Nicholas, farmer, h 9 Vernon
 Kearney Thomas, rem to Colorado
 Kearney Thomas, emp E. N. Foote & Co., bds 22 Market
 Kearns Patrick, laborer, h King
 Kearns Patrick, farmer, h South, Florence
 Keating Daniel, emp N H & N R R, h Mill Yard
 Keating James, laborer, h Mill Yard
 Keating John, laborer, h Mill Yard
 Keating John, attendant N L Hospital, bds do
 Keating Michael, emp W Mfg Co., h 42 Williams
 Keating Michael, laborer, bds Mill Yard
 Keating Michael, emp B Bros & Co., bds 9 Masonic
 Keating Michael, emp N Silk Co., bds Arch, Leeds
 Keating Michael, mason, h Masonic
 Keefe Hannah Mrs., h Warner, Bay State
 Keefe James, gardener at R R crossing, h King
 Keefe John, wire drawer, h Cottage Place
 Keefe Michael, laborer, h Hospital Hill
 Keefe Thomas, laborer, h 70 Bridge
 Keefe William, emp H. W. Clapp, bds 78 Bridge
 Keefe William, baker, emp S. Carr, bds Cottage Place
 Keefe William, emp H. W. Clapp, h Bridge, opp Lincoln av
 Kehoe James, laborer, h Bridge road
 Kehoe James, laborer, bds Ox Bow
 Kehoe John, laborer, h Bridge road
 Kehoe John, laborer, h Ox Bow
 Kehoe Peter, laborer, h Ox Bow
 Keirsch Ernest, emp B Bros & Co., bds Prospect c Locust, Florence
 Keith Jeremiah, inventor F Machine Co., h Chestnut, Florence
 Keller Gustave, emp Albert King, bds Myrtle, Florence
 Kelley Barney, emp C R R, bds Mill Yard
 Kelley Bridget Mrs., h State n Main
 Kelley John, emp N L Hospital, bds do

- Kelley Joseph, peddler, h Rust blk, South
 Kelley Julia A. Miss, teacher High School, Florence, bds Park n Pine, Florence
 Kelley Kate Miss, waiter Mansion House
 Kelley Michael, emp N Silk Co., h off Water, Florence
 Kelley Michael V., emp P. H. Dewey, h King
 Kelley Thomas, attendant N L Hospital, bds do
 Kellogg Benjamin A., foreman I. R. Clark, h Lincoln av
 Kellogg Charles A., teamster, h 9 Maple
 Kellogg Emma C., teacher, bds 9 Maple
 Kellogg Francis J., (J. E. Lambie & Co.), h 38 King
 Kellogg George C., supt F F Co., h 18 High, Florence
 Kellogg Henry, printer, rem to Hadley
 Kellogg Herbert C., emp Lee & Day, bds Lincoln av
 Kellogg Jonathan D., merchant, h West
KELLOGG JOSEPH M., real estate agent 149 Main, h 12 South.
 [See p 245.]
 Kellogg Levi R., farmer, h West n iron bridge
 Kellogg Lottie A. Miss, teacher, bds West
 Kellogg Minnie F. Miss, telephone operator, bds Center c Masonic
 Kellogg William A., book binder, rem to Gunnell, Ia
 Kendall Cordelia S. Mrs., bds Maple, Florence
 Kenney Charles, foreman N F Wheel Co., h Water, Leeds
 Kennedy James, farmer, h off West, Leeds
 Kennedy, printer, bds 2 King
 Kennedy James, emp G Mfg Co., h 28 River, Florence
 Kennedy Martin, laborer, h College av
 Kennedy Michael, emp G Mfg Co., h 27 River
 Kennedy Thomas, stone mason, h Critchlow, Leeds
 Kennedy Thomas F., laborer, h Smiths Ferry
 Kent Samuel E., hostler, rem to Springfield
 Kersey John, cutler N Cutlery Co., h Warner, Bay State
 Kermode Ann, widow Edward, h 22 Williams
 Kermode William, laborer, emp W Herrick
 Keyes Christopher C., stone mason, h 169 Main
 Keyes Edwin J., hackman, emp R. M. Guilford & Co., bds 169 Main
 Keyes Frank D., teamster, bds 7 Main, Florence
 Keyes John, h Main, Bay State
 Kibbe Henry, emp Watson & Chamberlin, bds Loudville, W Hampton
 Kidder Kate W. Miss, teacher, bds 18 West
 Kidder Myron L., piano tuner, h 18 West
 Kilbridge Patrick, emp L. J. Warner, bds Elm n Silk Mill
 Kiley Kate, widow Marcus, h Cutlery blk, Bay State
 Kiley Mary Miss, h Nonotuck, Florence
 Kiley Michael, foreman N Cutlery Co., h Cutlery blk, Bay State
 Kiley Thomas, baggage master C R R R, bds 11 State
 Kiley Thomas, mechanic, h 16 Chestnut, Florence
 Kiley William, mason, h 11 State
 Kimball Freeman J., joiner, h r 15 State
 Kimball George A., (Maynard & Kimball,) bds 37 Center
 Kimball Henry A., (Kimball & Cary), h Prospect n Park

Kimball James D., laborer, bds r 15 State

KIMBALL & CARY, Henry A. Kimball, Frank W. Cary), coal, wood and drain tile, Main c Hawley. [See p 265.]

Kindergarten School, Pine, Florence

Kindergarten School, 120 Main

KING ALBERT, mfr nitrate of iron and dealer in acids, head Holyoke, office and house Myrtle, F. [See p 241.]

King Alexander W., brush maker, h Pine, Florence

King Appleton, farmer, h 3 Holyoke

King Asahel B., h Green opp College avenue

King Delight Mrs., h 53 Prospect

King Frances C. Miss, clerk Cutler, Plimpton & Co., bds Pine, F

King James, book keeper T. Rust & Sons, h Green

King Joshua F., attendant N L Hospital, bds do

King Mary, widow James, h King

King Thomas, rem to Springfield

King William, emp M R B Co., bds Water, Leeds

Kingman Frank, rem to Springfield

Kingsbury Addison. (A. Kingsbury & Son,) res South Coventry, Ct

Kingsbury Arthur L., (A. Kingsbury & Son,) rooms 38 Main

KINGSBURY A. & SON, (Addison Kingsbury, Arthur L. Kingsbury,) paper box mfrs, Union blk 38 Main. [See p 240.]

Kingsbury Charles W., box maker, emp A. Kingsbury & Son, h 54 Elm

Kingsley Albert H., clerk J. E. Lambie & Co., bds Mansion House

Kingsley Calvin B., emp N H and N R R, h 12 Bridge

Kingsley Charles B., druggist 106 Main h 32 Elm

Kingsley Charles B. Jr., drug clerk 106 Main, bds 32 Elm

Kingsley Edward, bds Hampshire House

Kingsley Elijah, carpenter, h 15 South

Kingsley F. A., widow Horace, h North

Kingsley George, farmer, h Pine Grove

Kingsley Henry, carpenter, h 74 South

Kingsley Lewis H., printer, emp C. A. Snow, res Hatfield, Mass

Kingsley Mary B., widow Edwin, bds 210 Main

Kingsley Myra N., teacher, bds Union, Bay State

Kingsley Olive J. Miss, h Loudville

Kingsley William F., farmer, h 45 Pleasant

Kinney Charles M., nurseryman, h Prospect

KINNEY CHARLES W., marble and granite worker Court c King, h 4 Summer. [See p 272.]

Kinney Edward, clerk, bds Prospect

Kinney Fred, stone cutter, emp C. W. Kinney, bds 4 Summer

Kirby Edward L., clerk F Mach Co., bds 36 Main, Florence

Kirchhoff Sebastian, laborer, bds Smiths Ferry

Kirkland Harvey, h 17 Pleasant

Kirsch Ernest, emp B B & Co., bds Prospect

Kittredge Emerson P., cutter L. E. Jacobson & Co., rooms 210 Main

Klauss John, joiner, bds Gothic

Klinger Charles, silk dyer, h Lilly, Florence

Knapp Albert E., tinner, h 9 Clark av

Knapp Dovetailing Machine Co., dovetailing machinery, Main c Chestnut, Florence

- Knapp Lida C. Miss, dressmaker 8 Main, h do
 Knapp Rosa J. Miss, bds 8 Main
 Knapp William F., gardener, bds 9 Clark av
 Kneeland Benjamin F., emp W Mfg Co., h 38 Maple
 Kneeland Frederick N., cashier First Nat'l Bank, h Paradise road
 Kneeland Joseph C., inventor, h 10 Maple
 Knight E. P. Mrs., dressmaker Henshaw av
 Knight Ezbon P., livery, Henshaw av, h do
 Knight Harriet, widow L. E., h 9 Cherry
 Knight Horatio G., Pres N Inst for Savings and M R B Co., res
 Easthampton
 Knowlton Bros., (Franklin S., Wilbur F.), photographers, Dickinson's
 block, 22 Main
 Knowlton Charles L., physician 117 Main, h 16 Pleasant
 Knowlton Franklin S., (Knowlton Bros.) h High
 Knowlton Frederick J., clerk 60 Main, h 13 Franklin av
K **KNOWLTON JOSHUA**, boot and shoe dealer 119 Main, h 8 Fruit.
 [See p 257.]
 Knowlton Wilbur F., (Knowlton Bros.), bds High
 Knox Lorenzo R., mechanic F Mach Co., h High, Florence
 Koehler August, emp B Bros & Co., bds 24 Hawley
 Kramer Joseph, emp N Cutlery Co., h Maple, Bay State
 Kramer William, emp N Cutlery Co., bds Maple, Bay State
 Kreiner Charles, tailor, emp L. E. Jacobson & Co., h Green av
 Kron Joseph, emp Clement Mfg Co., h Main, Bay State
 Kuhn John Mrs., h Water, Leeds
 Kunzendorf Ernest, emp W Mfg Co., h 60 Bridge
 Kyle Oscar N., treas F Mach Co., bds 9 Main, Florence
- LABONTE ALEXANDER**, laborer, bds 49 South
 Lachapelle Bruno, broom maker, emp H. E. Smith, h 20 River
 Lacore Solomon, carpenter, h West n iron bridge
 Lacore Theodore, emp W Mfg Co., bds 8 Pleasant
 Lacrosse Joseph, laborer, h r 14 School
 Ladd Harlow, tin peddler, h Union, Bay State
 Lafleur Charles, painter, h West
 Lafleur George, emp W Mfg Co., h 28 Maple
 Lafleur Joseph, emp Clarke Inst, h 70 Pleasant
 Lafleur Joseph Jr., laborer, h 100 South n brick yard
 Laforce Theodore P., painter, emp John Tyler, h Masonic
 Laframboise Felix, (Laframboise & Dragon), h 106 State
 Laframboise & Dragon, (Felix Laframboise, Oliver Dragon), black-
 smiths and horse shoers, Masonic
 Lahey William, cutler N cutlery Co., h Cutlery blk, Bay State
 Laidley Caroline S. Miss, librarian N Public Library, bds 18 Maple
 Laidley David mason, h 9 Fruit
 Laidley Frederick, rem to Holyoke
 Laidley Julia M. Miss, assist librarian N Public Library, bds 18 Maple
 Laidley Marion, widow George, h 18 Maple
 Lalor James, Prof of music Smith College, bds Prospect n Park
 Lamb Catherine, widow Patrick, h 26 River, Florence

- Lamb Charles, wire drawer, h 1 Maple
 Lamb Charles H., supt Wire Mill, h 1 Maple
 Lamb Horace, (Horace Lamb & Co.), h 14 High
LAMB HORACE & CO., (Horace and Waldo H. Lamb), wire manufacturers, Clark av. [See p 238.]
 Lamb Waldo H., (Horace Lamb & Co.), h 15 Franklin av
 Lambie Jasper E., (J. E. Lambie & Co.) res Easthampton
LAMBIE J. E. & CO., (Jasper E. Lambie, Francis J. Kellogg), dry goods 64 Main. [See p 249.]
 Lamontagne Amable, emp W Mfg Co., h Rust blk South
 Lamontagne Joseph, carpenter, h 35 Williams
 Lamson Carroll M., clerk, bds Nonotuck House
 Lamson Ira O., clerk J. A. Sullivan, h 58 Bridge
 Lamson Stephen, h Crafts av
 Lamport Archibald K., book keeper Clement Mfg Co., h 62 Elm
 Lampro Oliver, emp W Mfg Co., h 22 Hawley
 Landergan John, farmer, h Loudville
 Landergan see Londergan
 Landers Bridget, widow James, bds Spring, Leeds
 Landrey Dennis, emp Brick Yard, bds Warner, Bay State
 Landrey Joseph, laborer, h Warner, Bay State
 Landry Medard J., emp C R R R, bds 53 Pleasant
 Landry John, emp Conn R R R, bds 53 Pleasant
 Landry Telesphore, (Larion & Landy), h Masonic
LANDY BROS. & CO., (John and Thomas Landy, John P. Joy), quarry head of Chestnut, Florence, sand bank Prospect, N. [See p 272.]
 Landy James, emp N Silk Co., h Spring, Florence
 Landy John, (Landy Bros. & Co.), h Nonotuck, Florence
 Landy Margaret Miss, h Nonotuck, Florence
 Landy Mary Miss, h Nonotuck, Florence
 Landy Thomas, (Landy Bros. & Co.), h Nonotuck, Florence
 Lane Edward H., coachman A. L. Williston, h Round Hill
 Langdon Charles J., carpenter, bds Arlington
 Langdon Edwin, emp F Mach Co., bds Fruit c High, Florence
 Langdon Jerry, teamster, emp Lee & Day, h 104 Main
 Langley Maurice, laborer, h 42 Market
 Lauphear William Henry, emp N Silk Co., bds Meadow, Florence
 La Plante Augustus, laborer, h 35 Williams
 Lapley Theodore, emp Caleb Loud, h Loudville
 Lapoint Francis, emp W Mfg Co., h 100 South
 Lapoint Isaac R., farmer, h 51 South
 Laport Theodore, carpenter, h Water, Leeds
 Larkin Maggie Mrs., h Spring, Leeds
 Larkin Thomas, emp M R B Co., bds Main, Leeds
 Laroche Alfred, emp W Mfg Co., h 60 Pleasant
 La Rose Louis, carpenter, bds 20 River
 La Rose Peter, carpenter, h Smiths Ferry
 Lasalle Joseph E., broom maker, emp H. E. Smith, h 32 Market
 Latham Henry, painter, bds West, Florence
 Latham John emp N Cutlery Co., h Water, Florence

Latham Matthew, farmer, bds West, Florence
 Latham William, emp Landy Bros. & Co., h West, Florence
 Latham William, farmer, bds Water, Florence
 Latham William Jr., stone mason, bds West, Florence
 Lathe Herbert W. Rev., pastor First Cong Church, h 18 Bridge
 Lathrop Henry, h 21 Bridge
 Lathrop J. S., h 11 Bridge
 Lattinville Adolphe, blacksmith, h 183 Main
 Laurion Frank, emp N Silk Co., h River, Leeds
 Laurion Leon (Laurion & Landry), bds 10 Market
 Laurion & Landry (Leon Laurion, Telesphore Landry), grocers, Ma-
 sonic, next engine house
 Laughlin Michael, emp N Outlery Co., bds Main, Bay State
 Lavake Charles W., farmer, h 72 King
 Lavake John L., pattern maker emp W. Herrick, bds 72 King
 Laventure Alexander, teamster, bds 49 South
 Lawler Catherine, widow Michael, h South, Florence
 Lawler James emp C Emery Wheel Co., h King c North
 Lawler, Stephen, laborer, h Mill Yard
 Lawler Thomas, laborer, bds Mill Yard
 Lawler Thomas, rem to Holyoke
 Lawrence Lillie A., widow John, h 17 West
 Laws William, fish dealer, h Center, Florence
 Lawson Frank, attendant N L Hospital, bds do
 Learned John B., physician, Main c Chestnut, h Holyoke, Florence
 Leary Dennis, emp N H & N Co., bds 1 Masonic
 Leary Dennis, laborer, bds Mill Yard
 Leary Mary Mrs., h Bridge, Florence
 Leary Patrick, emp F Mfg Co., bds Florence Hotel, Florence
 Leary Timothy J., clerk Matthew Carroll, bds Masonic
 LeDuc Joseph, brick mason, h Water, Leeds
 Lee Arthur B., ticket agt N H & N R R depot, bds 2 Strong av
 Lee Christopher T., h 21 Summer
 Lee James, bds 4 Maple
 Lee Mary Mrs., h 57 Prospect
 Lee Samuel W. (Lee & Day), h 2 Strong av
 Lee Samuel W. Jr., book keeper N Silk Co., bds L Dimock, Leeds
 Lee William W., treas Clement Mfg Co., h 29 Elm
LEE & DAY, (Samuel W. Lee, Wm. H. Day,) stove dealers and
 plumbers, 171 Main. [See p 263.]
 Leeds Emily L. Mrs., bds Round Hill Hotel
 Le Jean Baptiste (weekly), Menard, Belisle & Co., proprietors, 98
 Main
 Leonard Edmund, emp F Mach Co., h Nonotuck, Florence
 Leonard Edward W., mechanic, N E Wheel Co., h Leonard c Front,
 Leeds
 Leonard Emeline, widow Archelaus, h 20 Market
 Leslie Lillian Mrs., emp L. J. Warner, bds Elm n Silk Mill
 Levy Charles A., rem to Springfield
 Lewis Arabella, widow Lucius, h Center
 Lewis Charles C., rem to Cincinnati, Ohio

- Lewis Clara A., teacher, bds Maple c Smith
 Lewis Edward L., foreman Dickinson & Pomeroy, h Center n Masonic
 Lewis George, mechanic, h 14 Chestnut, Florence
 Lewis Oscar R. (R. Lewis & Son), bds Maple, c Smith
 Lewis Roland (R. Lewis & Son), h Maple, c Smith
L EWIS R. & SON, (Roland Lewis, Oscar R. Lewis,) grocers, 193
 L Main. [See p 261.]
 Lewis Mary, widow William S., h 3 School
 Lilley Mary A. widow George, h Arlington
 Lilley Walter, emp N Cutlery Co., h Arlington
 Lilly Alfred T., treas N Silk Co., h 3 Pine c Nonotuck, Florence
 Lilly Julia Miss, bds 3 Pine, Florence
 Lilly Lizzie H., widow Erastus, bds 37 Washington av
 Lincoln Addison J. (Lincoln & Bell), h 19 King
L INCOLN & BELL, (Addison J. Lincoln, Edward H. Bell), dry
 L goods and carpets, 70 Main. [See p 248.]
 Lindgren Emil, emp F F Co., bds N Main, Florence
 Lindgren Josephine C. Miss., h N Main, Florence
 Lines Patrick, laborer, h South
 Lines Timothy, emp W. F. Prindle, h off Bates
 Lipold John, farmer, h Easthampton road
 Lipshytc Benard, supt Nonotuck Pocket Book Co., h 17 Market
 Little Joseph, emp Day Bros., bds 32 South
 Little Louis, emp W Mfg Co., bds 32 South
 Littlefield Daniel G., pres F Mach Co. and F Mfg Co., residence
 Pawtucket, R. I
 Livermore Orrin E. (Smith & Livermore), h 31 West
 Livingstone Sarah, emp N Silk Co., bds 45 Main, Florence
 Lizotte James, emp C R L Co., Mt. Tom, h Smiths Ferry
 Lloyd Charles, mechanic, h 28 Walnut
 Lloyd Lyman H., h Main c Maple, Florence
 Lloyd Samuel, butcher, h 17 High, Florence
 Lloyd Theodore, switchman, bds 21 River
 Lloyd Thomas, rem to Haydenville
 Lock Elizabeth, widow William, h Main, Florence
 Locke Alvin M., baker emp S. Carr, h 28 Center
 Loizelle Oliver, emp W Mfg Co., h 88 South
 Londergan David, emp G Mfg Co., h Landy av c Nonotuck, Florence
 Londergan James R., cutler N Cutlery Co., h Main, Bay State
 Londergan John C., painter, bds 17 Gothic
 Londergan John W., painter, Main, h King
 Londergan Michael, emp Thos. Shea, h 17 Gothic
 Londergan Patrick, laborer, bds Landy av c Nonotuck, Florence
 Londergan Thomas, emp G Mfg Co., bds Landy av c Nonotuck, F
 Londigon Edward, emp Dickinson & Pomeroy, h 113 Main
 Londigon John, carriage washer Dickinson & Pomeroy, rooms do
 London & Liverpool Clothing House, Morris Tisch, prop., 42 Main
 Longden Charles emp N Cutlery Co., bds Warner, Bay State
 Longden James, N Cutlery Co., h Warner, Bay State
 Longden John, foreman N Cutlery Co., h Warner, Bay State
 Longley Henry A., sheriff and jailor Union, h do

- Look Emerson F., peddler, bds 17 Gothic
 Look Frank N., treas F Mfg Co., h Beacon n Pine, Florence
 Loomis Charles L., carpenter N Silk Co., h Main, Leeds
 Loomis Charles W., teamster and constable, h over N S Co. office, L
 Loomis Chester A., (G. L. Loomis & Co.), bds 15 King
 Loomis Curtis W., joiner, h r Masonic
 Loomis Fordyce W., h 7 Vernon
 Loomis Geo. L. (G. L. Loomis & Co.), h 15 King
L OOMIS G. L. & CO., (Geo. L. Loomis, Estus G. Clark, Chester
 A. Loomis), grocers, and carriage repository, 8 Pleasant. See p
 259.]
 Lord Edward A., emp J. L. Lord, bds 27 West
L ORD JOSEPH L., mattress mfr and renovator, 134½ Main, h
 27 West. [See p 278.]
 Lord Marietta Miss, bds Crafts av
 Lord Mary F. Miss, bds 214 Main
 Lorion Frank, sawyer N Silk Co., h River road, Leeds
 Loud Caleb paper mfr, Loudville, h do
 Loud Charles C., emp C Loud, h Loudville, Westhampton
 Loud Lucy Miss, dressmaker, 33 South, bds do
 Loud Nelson, carpenter, h 33 South
 Love Laura E. Miss, teacher high school, bds 22 King
 Lovegrove Charles E., attendant Shady Lawn, Gothic, bds do
 Loveland Milo, emp W Mfg Co., h 35 Market
 Lovely Fred, emp N Silk Co., h Water, Leeds
 Lovett Charles E., mechanic, h Beacon, Florence
 Loyer Jerry, blacksmith emp G. Backus, bds 30 N Main, Florence
 Luce Alden, rem to Williamsburg
 Lucia George N., cabinet maker, bds Round Hill
 Lucy John, laborer, h Olive
 Ludden Frederick M., laborer, h 95 South
 Lupien Thomas Mrs., h Main n Spring, Leeds
 Lussier Peter, emp W Mfg Co., h 9 Market
 Lussier Theophile, emp A. Wright, h 18 Olive
 Lyman Albert A., farmer, h Pine Grove
 Lyman Ahira, farmer, h Pine Grove n Florence
 Lyman Arthur L., clerk G. H. Walker & Co., bds 12 River
 Lyman Benjamin S., mining engineer, h 36 Elm n Paradise
 Lyman Burt G., farmer, h Pine Grove
 Lyman Clifford H., emp Bridgman & Childs, bds Clark av
 Lyman Dennis, hack driver H Whitcomb, bds Masonic
 Lyman Dwight, hackman, office Dickinson & Pomeroy, bds 21 River
 Lyman Edward H. R., tea merchant, h South
 Lyman Elias C. (Lyman & Shipman), rooms 66 Main
 Lyman Harriet Miss, h 56 Bridge
 Lyman Joseph, bds E. H. R. Lyman, South
 Lyman Lucy, widow Charles W., h 78 Bridge
 Lyman Luke, rem to Montreal, Canada
 Lyman Mary Miss, h Green
 Lyman Maurice W., wood turner N Cutlery Co., bds Main, Bay State
 Lyman Richard, clerk D. J. Wright, h 15 King

Lyman Sarah Miss, h 56 Bridge
 Lyman Sophia Mrs., h Main, Bay State
LYMAN & SHIPMAN, (E. C. Lyman, Charles E. Shipman),
 bakers and confectioners. 153 Main. [See p 258.]
 Lynch Alice Mrs., bds Leonard n Front, Leeds
 Lynch David, h Bridge, Florence
 Lynch David, Jr., emp N Cutlery Co., bds Bridge, Florence
 Lynch Honora, widow John, h 17 State
 Lynch James, grinder N Cutlery Co., h Bridge c Water, Florence
 Lynch John, laborer, h Hinckley
 Lynch John A., laborer, emp Conn R R R, bds Mill Yard
 Lynch John J., cigars, &c., Water, bds Bridge, Florence
 Lynch Michael, emp N R R, bds Mill Yard
 Lynch Michael gardener, bds Hawley
 Lynch Michael, emp C R R, h Mill Yard
 Lynch Michael B., emp W Mfg Co., h State c Park
 Lynch Patrick, laborer, bds Mill Yard
 Lynch William, emp cutlery shop, bds Bridge, Florence
 Lyons James, laborer, h Massasoit

MACOMBER CHARLES B., mason, h N Elm
 Macomber Frederick A., teller Hamp Co Nat Bank, h Myrtle n State
 Macomber Thankful H., widow S. J., h N Elm
 Mack Charles W., plumber emp W. F. Prindle, bds 13 River
 Mack John, h Arch, Leeds
 Macking Alexis J., bds Spring, Florence
 Macking Michael, farmer, h Spring, Florence
 Macking William H., farm hand, bds Spring, Florence
 Madden James, laborer, h 64 Prospect
 Madden James, farmer N L Hospital, h South, Florence
 Madden John apprentice, bds 4 North
 Madigan Patrick J., emp G Mfg Co., bds 30 Maple, Florence
 Madino Thomas, brick maker, bds 30 Maple, Florence
MADISON JOHN W., baker, Main opp hotel, Florence, h do
 [See p 258.]
 Maguire Jane Mrs., attendant N L Hospital, bds do
 Maguire Thomas P., hostler J. L. Draper, rooms over stable
 Mahar Edmund, emp B. M. Couch, h South, Florence
 Mahar Edmund 2d, tea peddler, h Nonotuck, Florence
 Mahar Mary widow Thomas, h Hinckley, Bay State
 Mahar Michael, emp C Cutlery Co., h Hinckley, Bay State
 Maher Philip, laborer, h Winter
 Mahar Thomas, tin peddler, h River, Florence
 Mahar William, laborer, h Vernon
 Mahoney Dennis, emp M R B Co., bds Main, Leeds
 Mahoney James, paper maker C. Loud, h Glendale, Easthampton
 Mahoney John, laborer, h Oak c Bridge road, Florence
 Mahoney Kittie Mrs., h State n Perkins av
 Mahoney Margaret, widow Timothy, bds 33 Williams
 Mahoney Mary Miss, waiter, Mansion House
 Mahoney Michael, rem to New Britain, Ct

Mahoney Michael, emp M B B Co., h Main, Leeds
 Mahoney Timothy, laborer, h West, Florence
 Mahoney Timothy, emp C R L Co., h 33 Williams
 Main George A., emp B Bros & Co., bds 21 Cherry
 Main Joseph H., teamster, bds Hockanum road
 Main Sarah J. Mrs, h 21 Cherry
 Maine Abel F., emp F Mfg Co., h Park, Florence
 Maine Bros. (Geo. W., Julius P.), meat market, Main n Maple, F
 Maine Flora E. Miss, teacher kindergarten, Florence bds Maple, F
 Maine Frank, emp F Mfg Co., h Park, Florence
 Maine Geo W. (Maine Bros.), h Main n Maple, Florence
 Maine Lewis, laborer, 32 Main, Florence, bds do
 Maine Lewis S., stone mason, h Haydenville road, Leeds
 Maine James Jr., laborer, h off Green
 Maine James L., laborer, h Maple, Florence
 Maine Julius P., (Maine Bros.), h N Maple, Florence
 Maiser John farm laborer, h N Elm opp Spring
 Major George, emp N Cutlery Co., h Cutlery blk, Bay State
 Maloney Hannah, widow Patrick, h Prospect n Franklin
 Maloney James, laborer, h West, Florence
 Maloney James, farmer, bds Easthampton road
 Maloney Jerry, laborer, h 86 South
 Maloney John H., driver Norwood Ice Co., bds 177 Main
 Maloney Mary E. Miss, milliner 139 Main, bds Prospect
 Maloney see Moloney
 Maltby Lafayette, Treas N Institution for Savings, h 12 Elm
 Manchester Henry F., emp F Mach Co., h Pine, Florence
 Mangan John, emp C. A. Maynard, h Elm n junc N Elm
 Mann Arnold A., h Pine, Florence
 Mann Eliza A. Mrs., fancy goods 10 Maple, Florence
 Mann Henry, teamster, h Hospital Hill
 Mann Melvin H., teamster, bds Hospital Hill
 Mann Wallace A., farmer E. H. R. Lyman, h Smith
 Manning Ellen, widow John, h r Masonic
 Manning James, h r 16 Walnut
 Manning James F., emp James Parnell 11 Pleasant, h Walnut
 Manning John, emp Shumway & Riley, h River, Florence
 Manning John C., printer, emp Gazette Printing Co., bds 10 River
 Manning Katie Miss, domestic 53 Elm
 Mannix Ann, widow Thomas, h 175 Main
 Mannix James H., cigar maker, emp T. J. Slattery, bds 177 Main
 Mannix John E., clerk 86 Main, bds 175 Main
 Mannix Michael, emp Clement Mfg Co., bds Warner, Bay State
 Mansfield Charles, book keeper, bds 16 Summer
 Mansfeld Honora, emp G Mfg Co., rooms Nonotuck, Florence
MANSION HOUSE, Rodney Brown proprietor, 129 Main. [See
 p 277.]
 Mantor James O., supt Hoe Shop, h 88 Elm
 Mara Catherine, widow Patrick, h West, Florence
 Mara John, silk dyer, h West, Florence
 Marble Alden, emp F Mach Co., h 26 Main, Florence

- Marble E. C. Mrs., h N Maple, Florence
 Marble Eugene C., slate roofer, rem to Easthampton
 Marble Geo. F., h N Maple, Florence
 Marble Judson, farmer, h Roberts Meadow
 Marble Mary A. Mrs., h Roberts Meadow
 March Fred J., clerk A. E. Hathaway 131 Main, bds 8 Walnut
 Marchant M., bds Mansion House
 Marcille Joseph, laborer, h Smith
 Marcotte Frank, carpenter, h High, Leeds
 Markle Christian, emp N Cutlery Co., h Norwood av
 Maroney Hanora, widow, h Haydenville road, Leeds
 Maroney Patrick, emp brass shop Haydenville, h Haydenville road
 Marriot Timothy, mason, h W Farms
 Marsh A. E., emp W Mfg Co., h 82 South
 Marsh Edward, sawyer, bds 109 South
 Marsh George L., rem to Suffield, Ct
 Marsh John, emp B Bros & Co., bds Cottage Place
MARSH JOSEPH, book seller and stationer 48 Main, h 22 Bridge.
 [See p 255.]
 Marsh Orsamus bds 52 Bridge
 Marsh Sarah M., widow William, h 16 Summer
 Marsh Willie B., clerk, bds 16 Summer
 Marshall Ethan, farmer, h Easthampton road
 Marshall James, emp N Silk Co., bds Maple, Florence
 Marshall Joseph I., laborer, h Smith
 Marshall Moses, rem to New York
 Marshall see Marcille
 Martel Edmond, rem to Worcester
 Martin Abel R., farmer, h Roberts Meadow
 Martin Gilbert, emp casket shop, h 57 N Maple, Florence
 Martin Michael, laborer, h Chestnut,
 Martin Roxana A., widow Joseph C., h Prospect, Florence
 Martin Joseph, emp Clement Mfg Co., h Federal, Bay State
 Martin Patrick, N P Co., h Federal, Bay State
 Martin Sarah E. Miss, bds Prospect, Florence
 Martin Thomas, emp E. Paper Co., bds Loudville
 Mason Clark E., emp F Machine Co., bds N Main, Florence
 Mason Edwin M., emp F F Co., bds, N Main, Florence
 Mason George E., rem to Vermont
 Mason Jarvis, h 54 Gothic
 Masonic Hall, 199 Main
 Mather C. Dwight, carpenter, bds 77 Elm
 Mather Frank C., mason, h 34 Washington av
 Mather Harriet H., widow William E., h 77 Elm
MATHER JOHN L., stone and brick mason and builder, h 77
 Elm. [See p 271.]
 Mather Sarah Mrs., nurse, bds 11 Clark av
 Matthews Avon C., (Matthews Bros.) bds 167 Main
 Matthews Bros., (A. C. & H. Matthews), builders, 167 Main
 Matthews Cora I., dress maker, Henshaw av
 Matthews Harry, (Matthews Bros.) bds 167 Main

Mathune Joseph, emp F Mach Co., h 15 Chestnut, Florence
 May Fred L., clerk C. N. Gabb, 121 Main, bds River, bey Gas Works
 May John, emp B Bros & Co., bds 24 Hawley
 May Joshua, laborer, h River bey Gas Works
 May William, rem to Montreal

MAYNARD CHARLES A., mfr hoes, shovels, &c., shop foot
 Green, coal and flour, 130 & 132 Main, h 74 Elm. [See inside
 back cover.]

Maynard Henry E., (Maynard & Kimball,) h 37 Center

Maynard Henry G., h Franklin

Maynard Otis R., cashier Shelburne Falls Nat Bank, h Prospect c
 Hinckley

Maynard Wallace emp W Mfg Co., h Pleasant n Holyoke

Maynard & Kimball, (Henry E. Maynard, George A. Kimball), bar-
 bers, 3 Pleasant

McAuliffe Jeremiah, painter, bds 30 Maple, Florence

McBride John, foreman M R B Co., h Water, Leeds

McBride Mary, widow Thomas, bds 30 Maple, Florence

McCabe James, tinner, emp Lee & Day, bds 11 State

McCahill Mary Mrs., h Fort

McCALLUM ALEXANDER, dry goods 116 Main, h Prospect
 [See p 248.]

McCANDLESS WILLIAM, liquor dealer and bottler. Agent
 for Warner Line Steamships, Masonic n Main, h 32 Washington
 av. [See p 283.]

McCarty Catherine Mrs., h Water, Florence

McCarty Ellen, widow Charles, h Franklin

McCarty Jerry, emp E Paper Co., bds Loudville

McCarty John, gate tender N H & N R R, h 48 Market

McCarty John, emp John Parnell, bds Market c Cherry

McCarty Patrick, emp W Mfg Co., h Mill Yard

McClellan James J., attendant N L Hospital, bds do

McConville James, foreman N Water Works, h r 16 Walnut

McConville Patrick, tailor emp Smith & Prindle, h Bates

McCormick Edward R., sewing machine agent 113 Main, Northamp-
 ton, h South, Florence

McClure Dennis, emp W Mfg Co., bds 12 Pleasant

McClure Fred, emp E. N. Foote & Co., h 32 Market

McClure Mitchell Mrs., bds 12 Pleasant

McCloud David, emp G Mfg Co., bds 30 Maple, Florence

McCloud J. Leroy, emp H Lamb & Co., h High

McCloud Milton L., carpenter, h 15 South

McCloud Moses S., rem to New Haven, Ct

McDonald Barbara Miss, attendant N L Hospital

McDonald John, printer, emp Metcalf & Co., rooms 10 Hawley

McDonald Maggie Miss, cashier Mrs. M K Olney, rooms 41 Center

McDonald Miss, emp N Silk Co., h Water

McDonald Owen E., cutler N Cutlery Co., h Cutlery blk, Bay State

McDonald Patrick, laborer, emp A Sawyer, h Locust, Florence

McDonnell Patrick, emp A. Sawyer, h Locust, Florence

McEurne John, emp Milo L. Smith, bds Smiths Ferry

McGee James, carpenter, h Main n Spring, Leeds
 McGee John, carpenter, bds Main n Spring, Leeds
 McGlinn Thomas Mrs., h Nonotuck, Florence
 McGookin Caroline, widow Patrick, h Maple, Bay State
 McGowan John, emp G Mfg Co., h Nonotuck, Florence
 McGowan Michael, emp Cotton mill, h 8 Nonotuck, Florence
 McGrath Ellen Mrs., h South, Florence
 McGrath James, clerk M Carroll, bds do
 McGrath John, laborer, h Bridge, F
 McGrath John, mechanic N S Co., h Water, Florence
 McGrath John, emp F Machine Co., h Hinckley, Bay State
 McGrath Patrick, laborer, h Winter
 McGrath Patrick, emp N Silk Co., bds South, Florence
 McGrath Robert, laborer, h off Nonotuck, Florence
 McGrath Robert, moulder F Mach Co., h Hinckley, Bay State
 McGrath Thomas, emp Clement Mfg Co, bds Hinckley, Bay State
 McGrath Thomas D., teamster H. E. Smith, bds 22 Market
 McGrath William, h King
 McGrath William, laborer, h Hinckley, Bay State
 McGuire Andrew, laborer, bds 20 King
 McGuire Andrew, emp Wm. Cooney, bds King
 McGuire see Maguire
 McIntie Henry, emp B Bros & Co., bds 8 Hawley
 McKenzie William, emp N Silk Co., h Main Florence
 McKinstry Edgar G., emp Emery Wheel Co., bds Leonard, Leeds
 McLane Michael, rem to So Deerfield
 McLaughlin Dennis, emp Amos Sawyer, bds Prospect
 McLaughlin Michael, emp Clement Mfg Co., bds Main, Bay State
 McLean Elias H., emp N Paper Co., h Mill, Bay State
 McLean Jane Miss, attendant N L Hospital
 McLean Janet, widow John, h Mill, Bay State
 McLean Johanna, widow John, h Mill, Bay State
 McMahon Frank A., mechanic F Mach Co., h 11 High, Florence
 McMahon John J. Rev., curate church of the Immaculate Conception,
 h Beacon, Florence
 McMillan Mrs., h 2 Pine, Florence
 McNarama John, emp E. N. Foote & Co., bds 1 Masonic
 McNarama Mary, h Nonotuck, Florence
 McNeil Sarah M. Miss, attendant N L Hospital
 McQuillan Mary, widow Philip, h Holyoke, Florence
 McRae Charles, emp M R B Co., bds Critchlow, Leeds
 McRae Jane, widow Christopher, h Critchlow, Leeds
 Meagher Nellie M. Miss, artist Knowlton Bros., bds 20 King
 Meehan Dennis, farmer, h South, Florence
 Meehan Dennis Jr., emp Cutlery Co., bds South, Florence
 Meehan Edward, emp N Cutlery Co., h Main, Bay State
 Meehan James, emp F Mach Co., h Nonotuck, Florence
 Meehan Johanna, widow Michael, h Cutlery blk, Bay State
 Meehan John, moulder, bds Nonotuck, Florence
 Meehan John, farmer, h South, Florence
 Meehan Margaret, widow William, h Nonotuck, Florence

- Meehan Mary, widow William, h Main, Florence
 Meehan Mary A., Miss, h 6 Prospect, Florence
 Meehan Patrick, emp N Cutlery Co., bds Cutlery blk, Bay State
 Meehan Timothy, laborer, h Haydenville road, Leeds
 Meekins Edward M., book keeper W Mfg Co., bds 6 Phillips Place
 Meekins Thomas H., bds 6 Phillips Place
 Meekins Thomas W., dentist 108 Main, h 6 Phillips Place
 Mehl Robert H. (Chas. E. Clapp & Co.), h 24 Walnut
 Meier Franz, laborer, h Locust, Florence
 Meirerhoff Ernest, h 60 Bridge
MENARD ADOLPHE, steamship and railroad ticket agt, Justice of the Peace, & (Menard, Belisle & Co.) 98 Main, h do. [See p 246.]
MENARD, BELISLE & CO., publishers Le Jean Baptiste, 98 Main
 Menard Francis X., shoemaker, basement 131 Main
 Menk Fred, emp B Bros & Co., h r 15 Gothic
 Mercier David, coachman N L Hospital, bds do.
 Mercier John, farmer, h Hospital Hill
 Meredith Wm. H. Rev., pastor Methodist Church, h Washington av
 Merrifield George E., dyer L. J. Warner, h 48 Main, Florence
 Merrill Frank L., rem to Weeks Mills, Me
 Merrill Hannah J. Miss, clerk 72 Main, bds Center av
 Merry Herbert W., rem to Worcester
 Merry John A., carriage maker, h Lilly, Florence
 Merry John C., carriage painter, emp R. B. Davis & Co., h 22 Market
 Merry Willard, emp F Mach Co., rem to Springfield
 Merwin L. M., widow Newton P., h 45 South
 Messier Damien, emp M R B Co., h Water, Leeds
 Messier Joseph, emp M R B Co., bds Water, Leeds
 Metcalf Albert E., machinist, h Loudville, Westhampton
 Metcalf Augustus, farmer, bds West Farms
 Metcalf Eli T., farmer, h West Farms
 Metcalf Frances W., widow William, h 6 Union
 Metcalf George L., clerk Oliver Walker, bds 6 Union
 Metcalf John, (Metcalf & Co.), h 7 Maple
 Metcalf Lewis W., assist editor Hampshire Gazette, bds 6 Union
 Metcalf S. C., widow Lyman, bds 9 Maple
 Metcalf Lyman, rem to New York
 Metcalf & Co., printers, over First Nat'l Bank, Main
 Methodist Church, (Rev. William H. Meredith) Center
 Metz Adolphus, cutler, h Main, Bay State
 Middleton Thomas, emp Clement Mfg Co., bds Hinckley, Bay State
 Milan Lizzie F., emp N Silk Co., bds Bridge, Florence
 Miles Edmund, painter, h Fort
 Miles George N., marble yard Holyoke St R R crossing, h Holyoke c Hawley
 Miles James, carpenter, h 28 Main
 Mill River Button Co., Main, Leeds
 Miller Abner D., carpenter, h 10 Olive
 Miller Andrew T., painter John Tyler, h Myrtle

Miller Bridget, widow David, h Nonotuck, Florence
 Miller Charles H., cutler N Cutlery Co., h Warner, Bay State
 Miller Charles W., laborer, h Hospital Hill
 Miller Edward, cutler, h N Elm
 Miller G. F., farmer, h 67 N Maple, Florence
 Miller Hermon, basket maker, h 8 Fruit
 Miller James, rem to Hadley
 Miller Jennie Miss, housekeeper, bds Water, Leeds
 Miller Kate Mrs., h Front
 Miller William, cutler, h N Elm
 Miller William C., barber emp 111 Main, bds King
 Miller William H., emp F Mach Co., h High, Florence
 Mills Henry, cutler N Cutlery Co., h Main, Bay State
 Mills Henry 2d, cutler, h Main, Bay State
 Mills James, laborer, bds Water, Florence
 Mills James Jr., rem to Springfield
 Minahan Bridget, H. Mrs., h Factory
 Minor Charles O., section master C R R R, h Williams
 Mitchell Catherine, widow James, h South n Brick Yard
 Mitchell Charles, mason, h off Main, Leeds
 Mitchell George, emp N. Day & Bros., bds South n Brick Yard
 Mitchell James, laborer, bds South n Brick Yard
 Mitchell W. G., rem to Cummington, Mass
 Moakler Catharine Mrs., h West, Florence
 Moakley Michael W., foreman N Cutlery Co., h Norwood av, B State
 Mockler James, laborer, h N King
 Mockler Kate Miss, music teacher, bds West, Florence
 Mockler Mary, widow Michael, h Kirkland av
 Mockler Thomas, laborer, h N King
 Mockler Thomas, emp W Mfg Co.,
 Moll Mary, widow James, h Leonard, Leeds
 Moloney James, farmer, bds Easthampton road
 Moloney John, farmer, h Easthampton road
 Moloney see Maloney
 Monahan John, laborer, h Mt Tom
 Mongeon Alba, turner N Silk Co., h Water, Leeds
 Mongeon Joseph, emp N Silk Co., bds Florence, Leeds
 Mongeon Ubalde, emp N Silk Co., h Florence, Leeds
 Montgomery Charles A., book keeper D. J. Wright, bds 19 West
 Moodie Emma Miss, attendant N L Hospital
 Moody Alvin, bds Lincoln av
 Moody Ceylon, farmer, h 72 South
 Moody Samuel, rem to Greenfield
 Moody William A., tinner, emp Eames & Sprague, h 16 Market
 Moonan Owen, laborer, h Hinckley, Bay State
 Mooney James, casket finisher, h Oak, Florence
 Mooney Joseph, emp N Paper Co., bds Mill, Bay State
 Mooney Mary Miss, emp N Silk Co., bds Maple, Bay State
 Mooney Michael, emp Gas Co., h 62 South
 Mooney Nicholas, emp Paper Mill, h Mill, Bay State
 Mooney Patrick, emp Gas Co., h Fort

- Moore Avery, h 22 Market
 Moore Frederick W., h 66 N Maple, Florence
 Moore Gilbert, mason, bds 10 River
 Moore Hulda, widow Charles, h 95 South
 Moore James, farmer, h N Farms
 Moore Joseph K., laborer, bds N Farms
 Moore Lincoln B., expressman, office I. A. Graves' Livery, Maple, h
 6 Main, Florence
 Moore William O., clerk N Silk Co., h High c Chestnut, Leeds
 Moore William O. Jr., laborer, bds N Farms
 Moore William N., farmer, h Bridge road, Florence
 Moore William N. Jr., farmer, h Bridge road, Florence
 Moquette Augustine, caterer, h 17 Pine, Florence
 Moran Bryan, farmer, h Leonard off Front, Leeds
 Moran Edward, emp M R B Co., bds Main, Leeds
 Moran Francis, emp M R B Co., h Main, n Spring, Leeds
 Moran Frances, emp M R B Co., h Main, Leeds
 Moran Herbert, laborer, bds 9 Market
 Moran James, emp M R B Co., bds Main, Leeds
 Moran Sarah, widow James, h Pleasant
 Morey Everett, attendant N L Hospital, bds do
 Morey Frank, engineer, bds Loudville, W Hampton
 Morey Horace, engineer C. Loud, h Loudville, W Hampton
 Morey John, emp W Mfg Co., h 44 Williams
 Morey Timothy, emp W Mfg Co., h 44 Williams
 Morgan Sophronia Mrs., h 6 Main, Florence
 Morgan William B., mechanic, h 9 Center, Florence
 Morin Caroline A., widow Edward, h 4 Grant av
 Morin Damos, emp Dr. E. E. Gaylord, h Maple
 Morin Damos Jr., emp W Mfg Co., bds Maple
 Morin Gilbert, laborer, bds 9 Market
 Morin Peter, emp W Mfg Co., h Smith c Maple
 Morley Fred E., machinist, bds 32 Vernon
 Morrelle Joseph, laborer, h 11 Cherry
 Morrissey John, emp N P B Co., bds 33 Pleasant
 Morrissey Patrick, mason, h 18 State
 Morrissey Patrick, cutler N Cutlery Co., bds Main, Bay State
 Morse Danford, engineer N L Hospital, bds do
 Morse Mary A. widow Anthony B., h Myrtle
 Morse Mary H., clerk, bds Myrtle
 Morse Selden L., carpenter, bds Maple, Florence
 Morton Charles W., retoucher emp Knowlton Bros., rooms Main, Bay
 State
 Morton Elmira Mrs., h 21 Pleasant
 Morton Harry, painter, bds 32 Market
 Morton Levi, lamplighter, h Bates
 Morton Levi P., saw filer and picture framer and chiropodist, room 5
 Union blk, 38 Main, h Cherry
 Morton Marcus, farmer, h 52 Bridge
 Morton Susan Mrs., bds 20 Summer
 Morton Thomas O., laborer, h off Bridge

- Mosier Henry, rem to Easthampton
 Mosier Joseph, emp Williston Mills, Easthampton, h Easthampton road
 Mosier Napoleon, rem to Brightwood
 Moulton Harry A., painter emp Whitcomb Bros., bds 19 Hawley
 Mourin John, carpenter, h over 14 Main
 Mousseau Francis, mason, h Water, Leeds
 Moyce Ann Miss, h 14 Summer
 Mulcahy Mary, h Fort
 Mulholland Alexander, laborer, h Hinckley
 Mulholland Henry, laborer, bds Hinckley
 Mulholland James, laborer, bds Hinckley
 Mulholland William, emp Tack Factory, bds Locust n Holyoke, F
 Mullaney Barney, emp N Paper Co., h N Prospect at R R crossing
 Mullee Thomas, mechanic, h Bridge, Florence
 Mullen James A., emp E Paper Co., h Loudville
 Mullen Michael A., emp E Paper Co., bds Loudville
 Munn Frank B., emp F F Co., bds Front e High, Florence
 Munsey Robert, broom maker, h Bates
 Munson Sadie Mrs., emp L. J. Warner, bds Elm n Silk Mill
 Munsou William S., turner N Silk Co., bds Nonotuck, Leeds
 Munyan Aubrey B., engineer C R R R, h 43 Bridge
 Munyan Alfred J., book keeper Kimball & Cary, h River
 Munyan Benson, district police, 24 Main, res Haydenville
 Munyan James C., farmer, bds 55 Bridge
 Munyan James L., farmer, h 55 Bridge
 Murphy Dennis, emp Clement Mfg Co., bds Main, Bay State
 Murphy John, emp F Mach Co., bds Spring, Florence
 Murphy Lucretia, widow Michael, bds off Green
 Murphy Margaret, widow Stephen, h South, Florence
 Murphy Patrick, barber, Maple, Florence, h do
 Murphy Patrick, emp N E Wheel Co., h Spring, Florence
 Murphy Peter, mason, h Massasoit
 Murphy Thomas, emp Clement Mfg Co., bds Main, Bay State
 Murphy Thomas, emp F Mach Co., h Spring, Florence
 Murray James, emp E. L. Clark, h 42 Market
 Murray Joseph, laborer, h N Elm, opp Spring
MURRAY JOSEPH, building mover and truckman, h King.
 [See p 274.]
 Murray Michael, rem to Lowell
 Murray Nelson, rem to Spencer, Mass
 Murray Peter, emp W Mfg Co., h Grant av
 Murray Thomas, emp W Mfg Co., h 44 Williams
 Murray Thomas J., engineer B Bros & Co., h 23 Hawley
 Musante Antonio, peanut vender, h Rust's blk, South
 Musante Joseph, fruit and peanuts, 11 Pleasant, h Rust's blk, South
 Mussner Frederick, tailor emp L. E. Jacobson & Co., h West

NADEAU FELIX, groceries, dry goods, &c., Bridge c Water,
 Leeds, bds do. [See p 261.]
 Nadeau Nazaire, clerk F. Nadeau, bds Water, Leeds

Nagel Louis, clerk Elm St House, bds do
 Nally Edward P., cutler N Cutlery Co., h Mill, Bay State
 Naramore Maria Mrs., h 28 Center
 Narrow Joseph, emp N Cutlery Co., h High, Bay State
 Nash George, painter, h Smiths Ferry
 Nash Sarah Miss, h Water n Bridge
 Navall Michael, engineer W Mfg Co., h Smith
 Neagle Pierce, cutler, h off Nonotuck, Florence
 Nelson A. Louise, dressmaker, bds 41 Market
 Nelson Joseph L., laborer, bds N Main, Florence
 Neuberger, rem to Newark, N J
 Newell Edgar, emp W Mfg Co., h 11 Maple
 Newell John, emp M R B Co., h Chesterfield road, Leeds
 New Haven & Northampton Co. Passenger Depot, Main c Strong av
 Newton Charles D., clerk Mansion House, h 5 Fruit
 Newton Clarence D., with Graves & Tucker, bds 11 Union
 Newton Jerome N., machinist, h 48 Market
 Newton Robert T., clerk 96 Main, bds 5 Fruit
 Nicholas Leonard, emp E Paper Co., bds Loudville
 Nichols Edward P., emp N H & N freight depot, h 65 Main, Florence
 Nichols Edward W., tailor 117 Main, h 9 River
 Nichols Willard M., emp F Mach Co., h Main, Bay State
 Nims Edward B., assist supt N L Hospital, bds do
 Nims Electa Mrs., bds 12 Bridge
 Niquette Louis B., physician 136 Main, h do
 Noble Arthur B., moulder, h 99 South
 Noble Cyrus D., carpenter, h 105 South
 Noble Linus, farmer, h 93 South
 Noble Maria, widow H. K., h 10 Clark av
 Nolan Frank, stone mason, bds Massasoit
 Nolan Jerry, laborer, h Pleasant c Williams
 Nolan John, laborer, bds Pleasant c Williams
 Nolan Mary, widow William, h Cemetery road
 Nolan Michael, laborer, h Pleasant c Williams
 North Albert, emp C Cutlery Co., bds Mill, Bay State
 North Albert E., emp Clement Mfg Co., bds Hinckley, Bay State
 North Mary Mrs., rem to Haverhill, Mass
 Nonotuck Boarding House, Nonotuck opp Main, Leeds
 Nonotuck Hall, Florence, Leeds
NONOTUCK HOUSE, E. O. Dalrymple, propr, Pleasant c Pearl.
 [See p 266.]
 Nonotuck Pocket Book Co., 9 Pleasant
NONOTUCK SILK CO., Nonotuck, Florence and Leeds. [See
 back cover.]
 Noonan Thomas, watchman M R B Co., h Main Leeds
 Norris Johanna, widow Richard, h Hospital Hill
 Norris John, laborer, bds Hospital Hill
 Northampton Beef Co., wholesale beef, market n R R Steam Mill.
 Northampton Club, First Nat'l Bank building, Main c King
NORTHAMPTON CUTLERY CO., Main Bay State. [See p 235.]

NORTHAMPTON EMERY WHEEL CO., Nonotuck, Leeds.
[See p 234.]

Northampton Gas Light Co., 105 Main

NORTHAMPTON ICE CO., T. Rust & Sons proprietors, 163
Main. [See p 260.]

NORTHAMPTON INSTITUTION FOR SAVINGS, Main c
Gothic. [See p 225.]

Northampton Lunatic Hospital, Hospital Hill

NORTHAMPTON NATIONAL BANK, 99 Main. [See p 227.]

Northampton Opera House, Chase Bros managers 120 Main

Northampton Paper Co., Vernon Bros & Co., props, Paper Mill Village

Northampton Post Office 123 Main

Northampton Public Library, Memorial Hall, Main

Northampton Street Railway Co., Strong av opp Conn R R Depot

Northampton Town Farm, Prospect ab Lawn av

Northampton Water Works, office Town Hall

Norton J. D. & Son, (Joseph D. and Leonard M. Norton), wood
turners, box and pat ladder mfrs, Loudville, Westhampton

Norton Joseph D., (J. D. Norton & Son), h Loudville, Westhampton

Norton Leonard M., (J. D. Norton & Son), h Loudville, Westhampton

Norton William, h Grant av

NORWOOD ICE CO., Ansel Wright manager, Opera House blk,
120 Main. [See p 266.]

Nowell Anna S., widow W. H., h 19 Green

Noyes Charles H., cutler, bds 18 Nonotuck, Florence

Noyes Julia A. Mrs., h 18 Nonotuck, Florence

Nute Charles C., hackman, emp R. M. Guilford & Co., h Bank av n
King

Nutting Arthur F., insurance agt 112 Main, h 13 Maple

Nutting Arthur J., clerk Mansion House

Nutting Ebenezer, h Park, Florence

Nutting Freeman E., mechanic, bds Park, Florence

Nutting John, rem to Shelburne Falls

Nutting Porter, brick mfr, yard Elm, (foot of hill), h N Elm

Nutting Susan G., widow E. P., bds 12 Green

OAKES NANCY S., widow Ebenezer, h 17 Center, Florence

Oberempt Herman, dyer Nonotuck Silk Co., bds Florence House, F

O'Brien Edmund, stone mason, h Hinckley, Bay State

O'Brien Edmund 2d, stone mason, h Bay State

O'Brien Garrett, cutler N Cutlery Co., h Hinckley, Bay State

O'Brien Hannah, widow Lawrence, h Cemetery road

O'Brien Johanna, widow William, h South, Florence

O'Brien John, bds Water, Florence

O'Brien John, gardener, h Williams c Front

O'Brien John, emp N Cutlery Co., h Main, Bay State

O'Brien John J., emp W & W Mfg Co., bds Nonotuck House

O'Brien Joseph, laborer, h r 15 State

O'Brien Mary Mrs., bds Bridge, Florence

O'Brien Merty, laborer, h Water, Florence

- O'Brien Nellie, emp N Silk Co., bds High n R R, Florence
 O'Brien Richard, mason, h Hinckley, Bay State
 O'Brien Richard, labòrer, h Bridge, Florence
 O'Brien Thomas, emp H. Lamb & Co., h Fort
 O'Brien William, emp N Silk Co., h Nonotuck, Florence
 O'Brien William carpenter, h Bridge, Florence
 O'Brien William P., grinder N Cutlery Co., h Massasoit
 O'Connell Daniel, butcher M. W. Jackson, h Slaughter House road
 O'Conner James, emp Brush Shop, h Bridge, Florence
 O'Conner Michael, fireman G Mfg Co., h 30 Maple, Florence
 O'Conner Michael, emp M R B Co, h Cook House, Main, Leeds
 O'Conner Thomas, emp N Silk Co., bds Nonotuck, Florence
 O'Conner Thomas, emp H. Lamb & Co., h King ab Spring
 O'Conner William, laborer, h Nonotuck, Florence
 O'Connors James, emp B Bros & Co., bds 62 Pleasant
 O'Connors James, cutler, N Cutlery Co., h High, Bay State
 O'Connors James, clerk Water, bds Park, Florence
 O'Conner see Conner and Connor
 O'Connor David, emp G Mfg Co., h Nonotuck, Florence
 O'Connor Thomas, emp G Mfg Co., h Nonotuck, Florence
 O'Connor Thomas C., clerk E. E. Hart, bds Main, Bay State
 Odd Fellows' Hall, 58 Main
 O'Dea James, laborer, emp Mrs. D. Thompson, Round Hill, bds do
 O'Donnell Daniel D., (O'Donnell & Herlihy), h Water, Florence
O'DONNELL JOHN B., lawyer, 120 Main, Opera House blk, h
 Beacon Florence. [See p 243.]
 O'Donnell Michael, polisher, bds Water, Florence
 O'Donnell Patrick, laborer, h King
 O'Donnell Peter Mrs., h South, Florence
 O'Donnell Julia, widow Terrance, h Nonotuck, Florence
 O'Donnell Thomas H., clerk P. H. Dewey, bds Mansion House
 O'Donnell & Herlihy, (D. D. O'Donnell, Thomas Herlihy), groceries
 and dry goods, Water, Florence
 Oehler Hermann, silk weaver, bds 7 Market
 Ogden Hannah L., widow George, h 88 Elm
 O'Grady Mary A., dressmaker, Nonotuck, Florence, bds do
 O'Grady Michael J., bds Nonotuck, Florence
 O'Grady Thomas R., farmer, h Nonotuck, Florence
 Ohlschlagel H., emp B Bros Mfg Co., bds 7 Market
 O'Keefe Edmund, laborer, h North c King
 O'Keefe Ellen Miss, bds Massasoit
 O'Keefe Ellen Mrs., h Massasoit
 Olds George H., mechanic F Mach Co., h Main n Holyoke, Florence
 Olds Stillman I., mechanic N E. Wheel Co., bds River road, Leeds
 Olds William H., carpenter, h Bates
 O'Leary Cornelius, emp W Mfg Co., bds 64 Pleasant
 O'Leary Jerry, wire drawer, bds 64 Pleasant
 O'Leary Margaret, widow Darby, h 64 Pleasant
 O'Leary Michael, laborer, h Hospital Hill
 O'Leary Timothy, clerk Matthew Carroll, Masonic, bds do
 Olin Alma D. Mrs., cook Shady Lawn, bds do

- Oliver Arthur, emp B Bros & Co., bds 5 Holyoke
 Oliver Frederick, emp B Bros & Co., h 5 Holyoke
 Olney Jane M., widow Merrill K., restaurant and caterer 143 & 145
 Main, h Bright
 O'Meara Phil, emp E. N. Foote & Co., h Winter
 O'Neil Bridget, widow John, h Water, Florence
 O'Neil Garrett, laborer, h Ox Bow Island
 O'Neil John, moulder, bds Main, Leeds
 O'Neil John laborer, h Spring, Florence
 O'Neil Julia, widow Patrick, h Main, Leeds
 O'Neil Kate Mrs., rem to Bridgeport, Ct
 O'Neil Michael, laborer, h Warner, Bay State
 O'Neil Morris, emp F Mach Co., bds Water, Florence
 O'Neil Richard, moulder, bds Main, Leeds
 O'Neil Thomas, bds Warner, Bay State
 Orcutt Thomas A., cabinet maker and undertaker Maple, h 15 High,
 Florence
 Organ John, emp A. Sawyer, h Cemetery road
 Organ William, emp A. Sawyer, h n N Elm
 O'Rourke John, emp N H & N R R Co., rooms 26 Pleasant
 Osborn Edward J., cutler Clement Mfg Co., h 94 State
 Osgood George V., book keeper E. N. Foote & Co., h 56 Elm
 Osgood Harriet K., teacher drawing and painting 17 Elm, bds do
 Osgood John, bds 56 Elm
 Osgood John E., machinist h Main c Beacon, Florence
 O'Shaughnessey Michael, laborer, h Hinckley
 Ostrom Louise Miss, Washburn House, Smith College
 O'Sullivan Eugene, laborer, h Hospital Hill
 O'Sullivan Henry C., clerk O'Donnell & Herlihy, h 21 Chestnut, F
 O'Sullivan Mary, widow, Daniel h Hospital Hill
 Otis Harry P., supt N E Wheel Co., bds 9 N Main, Florence
 Otis John L., sec and treas N E Wheel Co., h 9 N Main, Florence
 Otis Philip A., foreman N E. Wheel Co., bds 9 N Main, Florence
 Otto Ernestine Mrs., h Spring, Florence
 Onellett Ferdinand, laborer, h 22 Hawley opp B Bros & Co

 PACKARD CHARLES E., farmer, h Haydenville road, Leeds
 Packard Edward, rem to Williamsburg
 Packard Herbert N., tack maker F Tack Co., h Holyoke, Florence
 Packard Horace H., carpenter, h Holyoke, Florence
 Palmer Joseph W., book keeper C R L Co., rooms 26 Pleasant
 Papanti L., artist, rem to Holyoke
 Papillion James, compositor Hampshire Herald
 Paquette Joseph, emp Day Bros, h South at brick yard
 Paquette Peter, rem to Canada
 Paquin Narcisse, tailor 82 Main, h Perkins av
 Parent Alfred, cutler, h Main, Bay State
 Parent Anthony, broom maker, emp H. E. Smith, h 22 Williams
 Parent Mitchell, broom maker, emp H. E. Smith, h 22 Pleasant
 Parent Theophilus, broom maker, h r 22 Hawley
 Parenteau Alfred, painter N L Hospital, h Hospital Hill

Parin Peter, emp C R L Co., h Smiths Ferry
 Parker Joseph, rem to Holyoke
 Parker Mary A., widow Frank, h Center, Leeds
 Parker Mary G. Miss, housekeeper Girls' Classical School, Prospect
 Parker William, overseer spool shop N S Co., h West
 Parker Wm B., sec and book keeper M R B Co., bds Front c Chestnut, Leeds

PARKHURST L. B., Homeopathic physician, office 20 Pleasant, h 31 do. [See p 243.]

Parnell Bridget, widow Lawrence, h Hinckley

PARNELL JAMES, billiard hall 11 Pleasant, h Hinckley. [See p 284.]

Parnell John, liquor dealer 6 Pleasant, h 2 Cherry

Parnell Mary, widow Michael, bds Hinckley

Parnell William, laborer, h Prospect n Franklin

Parsons Charles O., agent Florence Clothing Store, bds Main c Maple, Florence

Parsons Charles T., farmer, h 3 Maple

Parsons Chauncey E., farmer, h 34 Bridge

Parsons Clayton S., farmer, h 5 Maple

Parsons Edward, farmer, h Pine Grove

Parsons Eliza L., widow Edwin C., h 11 Vernon

Parsons Enos, (Parsons & Crossley), attorney-at-law 52 Main, h South n Main

Parsons Frank S., student, bds South n Main

Parsons Harriet A., widow J. M., h 3 River

PARSONS HORACE K., clothing, coal, flour and feed, Main c Maple, h do Florence. [See p 253.]

Parsons H. Lincoln, clerk bds Main c Maple, Florence

Parsons Isaac S., office 90 Main, h Park, Florence

Parsons Josiah, farmer, h 37 Bridge

Parsons Joseph B., register of Probate, Court House, h 11 West

Parsons Joseph C., rem to Westfield

Parsons Julia, widow Lewis, h 10 South

Parsons Lewis D., (Clark & Parsons), rooms West opp College grounds

Parsons Lyman Mrs., h 34 Bridge

Parsons Minerva Miss, bds 11 Vernon

Parsons Philo M., farmer, bds 3 Maple

Parsons Samuel B., (S. L. Parsons & Son), h 14 West

Parsons S. C. Mrs., h Henshaw av

Parsons Samuel L., (S. L. Parsons & Son), h 12 West

PARSONS S. L. & SON, (S. L. and S. B. Parsons), truckmen and graders, 12 West. [See p 273.]

Parsons Spencer, farmer, h Pine Grove

PARSONS & CROSSLEY, (Enos Parsons, Azro T. Crossley), attorneys-at-law, Kirkland's blk, 52 Main. [See p 242.]

Partenheimer William, foreman spinner N S Co., h Grove av c Center, Leeds

Partridge Edward B., h Union

Partridge Elihu K., h 53 Pleasant

Partridge Fred F., book keeper City National Bank Holyoke, bds 31 Gothic

Partridge George, emp F Mach Co., h Spring n Leeds
 Partridge John H., painter h Grant av
 Partridge William E., night watchman, h 31 Gothic
 Patrell, emp F Mach Co., h Chestnut ab High, Florence
 Patrick Joseph, laborer, h Water n Bridge
 Patterson Louise C. Miss, teach Grammar school No 2, bds 10 South
 Paul Nelson W., miller, h School c Clark av
 Payne Mary H. Mrs., h 74 Elm
 Peabody E. S. Mrs., rem to Machias, Me
 Pearce J. S. Rev., Rector Episcopal Church, h 33 Bridge
 Pearsall Thomas W., treas C R L Co, res New York
 Pease Emerson F., laborer, h N Main, Florence
 Pease Lorenzo M., rem to Springfield
 Pease Lucy, widow Willis, h N Main, Florence
 Pease Robert H., grocer, flour, grain &c., Maple, h 14 Center, F
 Pease Solomon, h 20 Williams
 Peaseley Samuel, laborer, h 82 Bridge
 Peck Sadie Miss, clerk C. H. Pierce, bds 10 Green
 Peet H. G., magnetic physician 84 Main, h do
 Pelky Joseph, painter, h 9 Market
 Pellissier Joseph N., clerk A. McCallum 116 Main, bds Masonic
 Pellissier Louis, h r Masonic
 Pellissier Louis Jr., carpenter, h 191 Main
 Pellisier Rock, emp H. E. Smith, h 32 Market
 Peloquin Martin, broom maker, emp H. E. Smith, h Walnut
 Pelton Edwin, farmer, h N Maple, Florence
 Pelton George, farmer, bds N Maple, Florence
 Pelton Mary G., widow Timothy, clerk office Register of Deeds, h 9
 West
 Pendergast John, laborer, h N Elm
 Pendergast Patrick, emp F Tack Co., h Maple, Bay State
 Pepin Louis, broom maker, emp H. E. Smith, h 16 Walnut
 Pepper William H., emp GAZETTE PRINTING Co., rooms 12 River
 Perigo John, gardener, h Bridge opp Lincoln av
 Perkins Polly W., widow Burr, h Grant av
 Perkins Clifford D., rem to New Haven
 Perkins Jeremiah, broom maker, h King
 Perkins see Paquin
 Perry Calvin, supt work shop at Jail, h Myrtle
 Perry Edward A., assist supt Co. Jail, bds Myrtle
 Peterson Gustave, silk dyer, h off Green n College av
 Phelon Dewitt C., emp B. M. Couch, h Lake, Florence
 Phelps Albert L., farmer, h 90 South
 Phelps Benjamin A., watch maker 80 Main, h State
 Phelps, Calvin W., farmer, h 90 South
 Phelps Charles S., student, bds Lake, Florence
 Phelps Charles W., teamster, h 29 Bridge
 Phelps Edward H., tinner emp Eames & Sprague, h 43 Center c State
 Phelps Edward W., farmer, bds Lake, Florence
 Phelps George E., carriage maker, bds 5 Masonic

PHELPS GEORGE S., wheelwright and carriage maker 7 Masonic, h 5 do. [See p 275.]

Phelps George W., emp E. N. Foote & Co., h State opp Center

Phelps H. E. Mrs., bds 57 South

Phelps Henry J., farmer, h 32 South

Phelps Henry L., fertilizers Strong av, n C R R R depot, res Southampton

Phelps H. S., machinist, h Lilly, Florence

PHELPS JOHN C., shoe dealer 54 Main, h 19 Union. [See p 254.]

Phelps John P., farmer, h Pine Grove

Phelps Julius, farmer, h Spring, Florence

Phelps Moses, farmer, h 102 South

Phelps Samuel, farmer, h 102 South

Phelps Samuel A., machinist, h 35 Washington av

Phelps Solomon, h Lake, Florence

Phelps Timothy P., farmer, h West Farms

Phelps Watson T., farmer, h West Farms

Phelps William C., clerk G. L. Loomis & Co., bds 5 Masonic

Phillips Betsey Mrs., h Center av

Phillips Mary E., widow Edward W., h Center, Florence

Phillips Spencer H., emp L. W. Smith, h Masonic

Picard Charles, painter I. R. Clark, bds Pleasant

Picard Daniel, assist physician N L Hospital, bds do

PIERCE CHAUNCEY H., insurance and real estate agent over Northampton Ins for Savings, h 9 Union. [See p 245.]

Pierce Florella, widow Chauncey, bds 9 Union

Pierce James M., painter John Tyler, h Crafts av

Pierce Julius F., rem to Gilbertville

Pike Emily Mrs., h 4 Park

Pillinger Walter E., attendant N L Hospital, rooms West n iron bridge

Pillon Felix, emp N S Co., h Grove av, Leeds

Pipin Joseph, carpenter, res Easthampton

Pipin Louis, broom maker, emp H. E. Smith, h 16 Walnut

Pitchelter F., carpenter, bds Kirkland av

Pitchetter Peter, emp W Mfg Co., res Hadley

Pitman Elmore B., foreman cloth department G Mfg Co., h 17 Nonotuck, Florence

Pittsinger Alfred E., mechanic F Mach Co., bds Lilly, Florence

Pittsinger Asa, carpenter, h 29 West

Pittsinger James W., confectionery and restaurant 20 Main, h 22 do

Pittsinger William E., carpenter, h 24 Franklin

Place Isaiah, emp Clapp's saw mill, bds 78 South

Place Theodore M., inquire 21 Vernon

Plant M. H., emp G Mfg Co., bds 30 Maple, Florence

Plimpton L. F., (Cutler & Plimpton), h 7 Center, Florence

Plimpton R. B. Mrs., h Chestnut n Main, Florence

Plummer Mary M., widow John, h Massasoit

Pocket Joseph, foreman N. Day & Bros brick yard, h South n brick yard

Podgorski C. M., music teacher 155 Main, h do

- Poisson Albert, rem to Springfield
 Police Station, Masonic
 Pollard Alphonso P., clerk John Parnell, bds 5 River
 Pollard William H. Jr., shipping clerk F Tack Co., h 63 Main, F
 Pollard William H., veterinary surgeon, office 90 Main N, bds Florence
 Hotel, Florence
 Polmatier Clark W., plumber Eames & Sprague, bds Kirkland av
 Polmatier Jonas A., mechanic F Mach Co., h 63 Main, Florence
 Pomeroy Bedad, farmer, h Loudville, Westhampton
 Pomeroy Charles, blacksmith, h Fort
 Pomeroy Charles P., emp W. C. Pomeroy, bds North c Lincoln av
 Pomeroy Charles R., (Dickinson & Pomeroy), h 8 King
 Pomeroy Elvira C. Miss, (Wetherbee & Pomeroy), bds 26 Center
 Pomeroy Franklin J., farmer, bds Loudville, Westhampton
 Pomeroy Gaius, farmer, h West
 Pomeroy Gaius, farmer, bds 40 South
 Pomeroy Lucy Mrs., h West
 Pomeroy Walter C., foreman M R B Co., res Haydenville
POMEROY WILLIAM C., stair builder, planing and moulding
 mill, Center, h North c Lincoln av. [See p 269]
 Pomeroy William N., clerk William Dearden 32 Main, bds North c
 Lincoln av
 Poole Thomas, engineer F Mfg Co., h Spring, Florence
 Poor Frances F. Miss, attendant N L Hospital
 Porier John B., carpenter, h 16 Summer
 Porter Calvin, reporter Hampshire Gazette, h 8 Pine, Florence
 Porter Edward, emp E. P. Knight Henshaw av, bds do
 Porter Ernest A., emp F. Mach Co., bds 22 Main, Florence
 Porter Leo H., telegraph operator, bds 8 Pine, Florence
 Porter Samuel, supt N Silk Co., h Prospect c Pine, Florence
 Porter Thomas, emp F Mach Co., h 22 Main, Florence
 Potter Cyrus, polisher, h Main, Florence
 Potter Henry M., deputy sheriff and auctioneer, Opera House blk 120
 Main, h 4 Maple
 Potter Josiah H., mechanic F Mach Co., h Main, Florence
 Potter William, emp F Mach Co., bds Fruit c High, Florence
 Powell Oscar C., tinner, emp Eames & Sprague, h 69 N Maple, F
 Powers Ellen Mrs., bds Summer n State
 Powers Hannah W., widow Michael, h Bridge, Florence
 Powers James, cutler Clement Mfg Co., bds Main Bay State
 Powers James, emp B Bros & Co., bds State n Perkins av
 Powers James D., foreman skeining dept B B & Co., bds State
 Powers John, laborer, h Prospect ab Franklin av
 Powers John, farmer, h North Farms
 Powers John, laborer, bds off Bridge
 Powers John, farmer, h South, Florence
 Powers Lawrence, helper R. B. Davis & Co., res Easthampton
 Powers Lawrence, emp W Mfg Co., h 24 Market
 Powers Luke, emp Clement Mfg Co., h Federal, Bay State
 Powers Martin, laborer, h r 34 Bridge
 Powers Michael, h South, Florence

- Powers Michael, tailor, emp Merritt Clark & Co., bds 11 State
 Powers Michael W., policeman, h West
 Powers Morris, cutler N Cutlery Co., bds Cutlery blk, Bay State
 Powers Patrick, farmer, h Sandy Hill
 Powers Patrick, cutler N Cutlery Co., bds Main, Bay State
 Powers Patrick, laborer, h State n Perkins av
 Powers Richard, broom maker, h 80 Bridge
 Powers Richard, laborer, h Meadow off Bridge
 Powers Richard, mason, h King
 Powers Richard Jr., clerk 159 Main, bds off Bridge
 Powers Thomas, farmer, h South, Florence
 Powers Thomas C., cook N L Hospital, h Hospital Hill
 Powers William, laborer, h Cutlery blk, Bay State
 Pratt Charles S., carpenter and builder, h 11 North
 Pratt Charles S. Jr., pattern maker, emp W. C. Pomeroy, bds 11 North
 Pratt Hattie H., teacher, bds 11 North
 Pratt Helen M. Miss, teacher, bds 23 Market
 Pratt Henry L., carpenter, h Chestnut
 Pratt Joseph, building mover, h Rust blk, South
 Pratt Orrin, cabinet maker South c Main, h 23 Market
 Pratt Thomas Mrs., bds 20 Union
 Pratt William F. (W. F. Pratt & Son), h 43 King
 Pratt William F. Jr., (W. F. Pratt & Son), bds 43 King
P **PRATT W. F. & SON**, (Wm. F. Pratt, Wm. F. Pratt Jr.) ar-
 chitects 105 Main. [See p 268.]
 Pratt William O., teacher, bds 23 Market
 Preece James, emp H. Lamb & Co., h 5 State
 Prentice Pamela, widow John, bds 6 Center, Florence
 Prentiss John A., watch maker, h 10 Cherry
 Prentiss Helen Miss, bds 10 Cherry
 Presbrey Luther C., milk dealer, h North Farms
 Preston Wm H., carpenter, h 78 Bridge
 Pretty Adam, laborer, h Prospect ab Massasoit
 Priest James, laborer, h Center
 Prince Bridget Mrs., h West, Florence
 Prince John, book keeper Northampton Nat'l Bank, bds 16 Bridge
 Prince Kate Miss, music teacher, bds 20 Bridge
 Prindle Josiah H., merchant tailor, (Smith & Prindle), bds 204 Main
P **PRINDLE WILLIAM F.**, stove dealer, plumber, steam and gas
 fitter, and drain pipe 149 Main, h 17 South c Clark av. [See p
 263.]
 Probate Court, Court House
 Proulx Philias, emp N Silk Co., h Water, Leeds
 Prouty Clifford H., emp N Street Railway, bds 167 Main
 Prouty Emerson F., harness maker, emp H. P. Smith 165 Main, h
 Cottage Place
 Prouty Waldo Mrs., bds 78 South
 Prue Joseph, brick maker, h Easthampton road
 Puffer Charles W., laborer, bds Massasoit
 Puffer Henry L., painter, h Franklin n Prospect
 Puffer Thomas, laborer, h Massasoit

Purseglove Thomas, cutler N Cutlery Co., h Hinckley, Bay State
 Purcell John, contractor C Mfg Co., h off Nonotuck n Main, Florence
 Purcell Patrick, h Spring, Florence
 Purcell Patrick, (Donovan & Purcell), h Main, Leeds
 Purcell Patrick Jr., rem to Unionville, Ct
 Purcell Peter, rem to Unionville, Ct
 Purcell Sarah L., widow William, h Water, Florence

QUIGLEY WILLIAM F., farmer, Florence, Leeds
 Quigley William H., farmer, bds Florence, Leeds
 Quinlan John, brush maker, bds 30 Maple, Florence
 Quinn Edmund, emp N Silk Co., h Spring, Florence
 Quinn Patrick E., cook Hampshire House, rooms 15 Gothic
 Quinn Patrick W., carpenter, h 57 Prospect
 Quinn Thomas, emp N H & N R, h Mill Yard
 Quinn Thomas, engineer Mt Holyoke, h 15 Gothic
 Quirk James, janitor Smith College, h Prospect
 Quich Kate Miss, housekeeper, 6 Hawley

RACKETT MARTIN, laborer, h West, Florence

RAFTRY THOMAS, meat market, 7 Pleasant, h North, opp
 Lincoln av. [See p 262.]

Rahar Richard, laborer, h Elm n N Elm
 Raino Joseph, emp W Mfg Co., bds 9 Market
 Raino William, emp Day Bros., h South ab Brick Yard
 Raleigh John J., painter emp W. L. Smith & Co., h Crafts av
 Ralston Margaret Miss, asst librarian N Public Library, bds 18 Maple
 Ramage James, farmer, h Smiths Ferry
 Rand Jessie A. Miss, night watchwoman, N L Hospital, bds do
 Randall Hiram M., truckman, h 7 River
 Randall Susan Mrs., rem to Hartford, Ct
 Randall William, rem to Hartford, Ct
 Rankin Jesse H., telegraph operator Conn R R depot, h Grant av
 Rankin Mrs., h Grant av
 Ranney David F., supt mach dept, F Mach Co., h Chestnut, Florence
 Ranney Lyman J., foreman N Silk Co., h 34 Pine, Florence
 Rathburn Charles, rem to Ilion, N. Y.
 Raubach Evan, rem to New York
 Rauch Henry, silk dyer, h Nonotuck, Florence
 Rawson Abby M. Miss, emp N Silk Co., bds Holyoke, Florence
 Rawson Clara E. Miss, bds Holyoke, Florence
 Rawson Rachel Mrs., h Holyoke, Florence
 Ray Eliza J. Miss, bds 33 Gothic
 Ray George H., book-keeper N Silk Co., h Front, Leeds
 Ray George K., carpenter N Silk Co., h Front, Leeds
 Ray Myron, machinist, h 5 Hawley
 Readio Charles, bds Chestnut ab High, Florence
 Readio Frank M., moulder F Mach Co., bds 19 Chestnut, Florence
 Readio Fred W., carpenter, h Myrtle, Florence
 Readio Mary E., widow George A., h 19 Chestnut, Florence

- Ready Frank, laborer, bds r 14 School
 Reardon Bridget Mrs., h Spring, Florence
 Reardon Cornelius, laborer, h River, Florence
 Reardon Daniel T., laborer, h West, Florence
 Reardon John, emp N Paper Co., h Main, Bay State
 Reardon Philip, emp F Mach Co., bds 30 Maple, Florence
 Reece Elizabeth Mrs., h Main, Florence
 Reece Emma W. Miss, clerk E. S. Ross, bds Front, Leeds
 Reece Henry, farmer, h Bridge road, Florence
 Reece James E., farmer, h W Farms
 Reece William A., h Main n Nonotuck, Florence
 Reece William H., machinist emp Emery Wheel Co., h Florence,
 Leeds
 Reed Sarah W., widow Franklin, h 17 West
 Reene Joseph, emp Albert King, h Nonotuck, Florence
 Registry of Deeds, County Court House
 Registry of Probate, County Court House
 Reid Andrew J., peddler, h Olive
 Remillard Homer, blacksmith emp R. B. Davis & Co., h r Masonic
 Remington Albert, laborer, h River Meadows
 Remington David T., produce, Center c Chestnut, Leeds
 Remington Heman, laborer, h off Bates
 Reock Phoebe C. Miss, bds 60 Elm
 Rhoads Leonard W., machinist, h 26 Market
 Rhodes Emma C. Miss, rooms Center av
 Rhoad Henry G., farmer, h Roberts Meadow
 Rhoad Willie D., teamster, bds 7 Main, Florence
 Rood Louise J. Mrs., h Fruit, Florence
 Rial Cecile, attendant N L Hospital
 Rial Nicholas, gardener N L Hospital, h Mill, Bay State
R **RICE BENJAMIN F.**, horse shoer and jobber, 10 Fruit, h do.
 [See p 276.]
 Rice Clark G., farmer, h Bridge n Chestnut, Florence
 Rice Clifford F., contractor F F Co., bds 56 N Maple, Florence
 Rice David A., emp W Mfg Co., h 6 Maple
 Rice Edward C., bds Loudville, W Hampton
 Rice Emeline Miss, bds Pine, Florence
 Rice F. Joseph, steward N. L Hospital, h 67 Elm
 Rice Francis N., bds Pine, Florence
 Rice George P., book-keeper E Paper Co., bds Loudville
 Rice Henry B., restaurant C R R R depot, h 5 Strong av
 Rice Lucius, painter, bds Lilly, Florence
 Rice Lyman, bds 10 Fruit
 Rice Mary F., widow J. H., clerk A. McCallum, 116 Main, h 10
 Hawley
 Rice Nicholas, night engineer N L Hospital, bds do
 Rice Sarah D., widow Stanford J., h Lilly, Florence
 Rice Samuel D., engineer F F Co., h High n Fruit, Florence
 Rice William H., farmer, h West Farms
 Richards Daniel, emp N Silk Co., h Water, Leeds
 Richards Edward E., clerk Clark & Parsons, bds Masonic

- Richards Frederick G., janitor and keeper Lock-up, Masonic, h do
 Richards Frederick G. Jr., emp W. L. Smith & Co., bds Masonic
 Richards George S., rem to Buffalo, N. Y
 Richards Joseph, emp W Mfg Co., h 62 Pleasant
 Richards Joseph L., emp N Silk Co., h Liberty, Leeds
 Richards Lewis, clerk post office, bds 10 Park
 Richards Lydia A., widow Louis P., h 10 Park
 Richards Mary Mrs., h 1 Warner's row, Leeds
RICHARDSON CHARLES L., blacksmith, Court r Smith's blk,
 R h 54 Elm. [See p 276.]
 Richardson E. Lewis, rem to Springfield
 Richardson Oscar, rem to Ludlow
 Richardson R. E., h 13 Market
 Richardson William H., painter Gothic n Court, bds 36 Market
 Richey David F., mason, h 46 Market
 Richmond Fred H., emp F Mach Co., h 52 Main, Florence
 Richmond James O., clerk 64 Main, bds 23 Pleasant
 Ridlon Josephine L. Miss, book-keeper F Tack Co., bds 46 Main, F
 Riley Ann Mrs., h West, Florence
 Riley Catharine, widow John, h Maple, Bay State
 Riley Daniel, machinist, h Hinckley, Bay State
 Riley Dennis, emp F. Tack Co., h Holyoke, Florence
 Riley John, emp F Tack Co., bds Maple, Bay State
 Riley John B., printer emp Metcalf & Co., h Prospect
 Riley John E., dry goods and millinery, Davis blk, Main, F, bds 9
 Main, Florence
 Riley Joseph (Shumway & Riley), h 54 N Maple, Florence
 Riley Mary, widow Hugh, h Fruit, Florence
 Riley William H., reporter Springfield Republican, office Opera House
 Block, 120 Main, h Beacon, Florence
 Riordan John, fireman N Paper Co.,
 Ritter John, emp B Bros & Co., bds 20 Market
 Roach John, emp N Cutlery Co., h Mill, Bay State
 Roach Mary Mrs., h Mill, Bay State
 Roasner Ernest Hugo, emp B Bros & Co., h 23 River
 Robbins Chandler G., emp N Silk Co., bds Grove c Center, Leeds
 Robbins Darwin, basket maker, h Olive
 Robbins Leroy T., teamster, h West, Leeds
 Robbins Mary J. Miss, bds Center n Grove, Leeds
 Robbins Roxana Mrs., bds High opp Fruit, Florence
 Robbins Roxana G. Mrs., h Grove c Center, Leeds
 Robbins William W., teamster C A. Maynard, h Factory
 Roberts Daniel, teamster, emp W. D. Clapp, h Chestnut
ROBERTS E. A., jeweler 54 Main, bds 6 River. [See p 254.]
 Roberts Henry Mrs., h North
 Roberts John, stone layer, h Perkins av
 Roberts John 2d, coachman Elm c Massasoit, h State c Chestnut
 Roberts O. O., physician, King, h do
 Roberts Sylvester, emp F Mach Co., h Chestnut c High, Florence
 Roberts William E., clerk R. H. Pease, h N Maple, Florence

- Robertson James, h 20 Prospect, Florence
 Robinson Charles, carpenter, bds Kirkland av
 Robinson George P., book-keeper W. F. Prindle, 149 Main, bds Round Hill Hotel
 Robinson John, fireman, h 10 Walnut
 Robinson John D., proprietor Round Hill Hotel, and dealer in pianos and organs
 Robinson Lyman C., foreman weaving dept G Mfg Co., h 2 Nonotuck, Florence
 Robinson Reuben, engineer Clarke Inst. Round Hill, bds do
 Robinson Samuel, clerk 121 Main, bds 31 South
 Robinson Silas, bds High, Florence
 Robinson William C., book-keeper, emp Mass. Mutual Ins Co., of Springfield, rooms 46 Main
 Roche Joseph, emp W Mfg Co., h 44 Williams
 Rocheleau Felix, rem to Holyoke
 Rock Alexander, emp C R L Co., h 23 River
 Rock Charles, driver N St R C., bds River
 Rockett Martin, laborer, h West, Florence
 Rocky Johanna, widow Charles, bds Paper Mill road
 Rockwell Benjamin R., laborer N L Hospital, bds do
 Rockwell Luther J., laborer, bds Smiths Ferry
 Rodimon Walter S., agt Conn R R R, bds Mansion House
 Rodimon W. S. Mrs., dressmaker, 137 Main, bds Mansion House
 Rogers Frank, emp N Cutlery Co., h High, Bay State
 Rogers Harry, rem to Haydenville
 Rogers H. B. Miss, Principal Clarke Inst, Round Hill, bds do
 Rogers James, emp Clement Mfg Co., bds Main, Bay State
 Rogers Lewis, joiner, h Federal, Bay State
 Rondeau Oliver, emp N Silk Co., h Water, Leeds
 Rood George E., rem to Conn
 Rood George H., laborer, h 16 Olive
 Rood Jerusha, widow Josiah T., h West Farms
 Rood Rosina B. Mrs., h 3 River
 Rood William D., teamster, bds 7 Main, Florence
 Root C. Fred., emp Casket Shop, bds 64 N Maple, Florence
 Root Erastus P., emp John C. Jager, h 64 N Maple, Florence
 Root Merton A., carpenter F Mach Co., h Grant av
ROSE SAMUEL C., carriage trimmer, 7 Masonic, rooms 117 Main. [See p 275.]
 Rosebush George, emp Gilbert Rosebush, bds Pleasant
ROSEBUSH GILBERT, carriage maker, Main, opp Masonic, h Pleasant. [See p 276.]
 Rosebush Joseph, emp Day Bros., h Pleasant c Williams
 Rosebush Peter D., hostler H. G. Holley, bds 206 Main
 Rosebush see Derosier
 Rosenbaum Simon, clerk 6 Main, h 14 Cherry
 Ross Austin, farmer and milk peddler, h Meadow, Florence
 Ross Dwight A., farmer and milk peddler, h Meadow, Florence
ROSS EDSON S., general merchandise, Nonotuck, h Front, Leeds. [See p 261.]

Rothberg Abraham, emp Tigerite Mfg Co., bds Court
 Rothwell Thomas W., shipping clerk F Mach Co., h 7 Chestnut, F
 Round Hill Hotel, J. D. Robinson, prop'r, Round Hill off Elm
 Rouse A., emp Button Co., bds River, Leeds
 Rouse Joseph, laborer, h River, Leeds
 Rowe John, blacksmith, Main n Nonotuck, h West, Leeds
 Rowe Thomas, farmer, h West, Leeds
 Rowland Harriet N. Miss, nurse, h 7 Fruit
 Rowland Juliette Miss, dressmaker, h 7 Fruit
 Rowland Olivia J. Miss, h 7 Fruit
 Rowley Chauncey W., contractor F Mach Co., h 28 Washington av
 Rowley Henry R., rem to Springfield
 Rowley Myron J., baker emp J. W. Madison, h 64 N Maple, Florence

RUDER BRUNO, saloon 4 King, h do. [See p 284.]

Rummell George I., mechanic, h 4 Center, Florence
 Rummell Phil B., traveling salesman, bds Hampshire House
 Rush M. Thomas, joiner, h Lake, Florence
 Rushford John, polisher, bds 98 State
 Rushford John J., lithographer, emp C. A. Snow, bds Bates
 Rushford Joseph, teamster J. A. Sullivan, bds Bates
 Rushford Lewis, farmer, h Bates
 Rushford Lewis M., granite and freestone worker, r C. E. Clapp's
 foundry, h Lincoln av
 Rushford Mitchell, emp J. Murray, h 98 State
 Rushlow Victor, book-keeper Joseph Hebert, h 40 Williams
 Russell Aurelia E., widow Samuel, h King
 Russell Charles H., farmer, bds Florence, Leeds
 Russell George H., rem to Worthington
 Russell George P., emp N E Wheel Co., bds West, Leeds
 Russell John G., farmer, h West, Leeds
 Russell Leroy C., clerk, bds 23 Pleasant
 Russell Walter, rem to Chicopee Falls
 Rust Alvin (T. Rust & Sons), bds 17 Maple
 Rust Charles (T. Rust & Sons), h 161 Main
 Rust Fannie K., teacher, bds 5 Myrtle
 Rust Fordyce A., h Myrtle
 Rust Harry, freight clerk N H & N R R, bds Maple
 Rust Lewis, dentist, h 17 Maple
 Rust Mary E. Mrs., h Loudville
 Rust Stephen, box manufacturer and planing mill, h Loudville
 Rust Theodore (T. Rust & Sons), h 17 Maple

RUST T. & SONS, (Theodore, Alvin and Charles Rust) grocers
 and crockery, (Northampton Ice Co.), 163 Main. [See p 260.]

Ryan Catherine Miss, h Loudville
 Ryan Daniel, cutler N Cutlery Co., h Union, Bay State
 Ryan George, agent, h Holyoke, Florence
 Ryan James, emp Clement Mfg Co., bds Warner, Bay State
 Ryan James, farmer, h Pine Grove n Florence
 Ryan James, emp N Cutlery Co., h Bay State
 Ryan Jerry, emp J. D. Norton & Son, h Loudville

Ryan John, carpenter, h West, Florence
 Ryan John, rem to Whately
 Ryan John, emp N Silk Co., h Bridge, Florence
 Ryan John, hod carrier, h off Water, Florence
 Ryan Lawrence, emp W & C Paper Co., h Loudville
 Ryan Lawrence, moulder, h 18 Olive
 Ryan Lawrence, laborer, h Nonotuck, Florence
 Ryan Mary, widow John, bds Hospital Hill
 Ryan Mary, widow William, h Nonotuck, Florence
 Ryan Matthew, emp Clement Mfg Co., bds Landy av, Florence
 Ryan Nicholas, laborer, h Kirkland av
 Ryan Patrick, emp G Mfg Co., h Landy av, Florence
 Ryan Patrick emp M R B Co., h 1 Warner's row, Leeds
 Ryan Richard, emp Watson & Chamberlin, bds Loudville
 Ryan Thomas, farmer, h Main c Spring, Leeds
 Ryan Thomas, gardener, h State ab Spring
 Ryan Thomas, laborer, h Main, Leeds
 Ryan Thomas, brush maker, bds West, Florence
 Ryan Thomas, emp N H & N R R, bds Florence, Leeds
 Ryan Thomas J., brass finisher, h r Masonic
 Ryan Thomas J., bar tender Nonotuck House

SACKETT ANN E. Miss, bds Washington av
 Sackett John R. (R. W. & J. R. Sackett), h 68 Pleasant
 Sackett Rufus W. (R. W. & J. R. Sackett), h Olive
SACKETT R. W. & J. R., (Rufus W., John R.), furniture
 dealers and undertakers, 2, 4 and 6 King. [See p 253.]
 Sackett William R., upholsterer emp R. W. & J. R. Sackett, h King
 c Myrtle

SALOIS JOSEPH, truckman, r 35 Pleasant, h do. [See p 273.]

Sampson Fred, emp B Bros & Co., bds 45 Pleasant
 Sampson Mary, widow Lorenzo, h r 5 Strong av
 Sampson Mary C., widow Isaac, h Holyoke c Hawley
 Sanders Frederick D., blacksmith emp Levi I Clark, bds 10 River
 Sanderson C. B., proprietor Northampton and N Hadley stage line,
 office 26 Main
 Sanderson Eli W. (Sanderson & Delano), h 4 Sanderson av
 Sanderson George E. Rev., rem to Easton, Mass
 Sanderson Lucy Mrs., h 17 West
 Sanderson & Delano (Eli W. Sanderson, Jesse L. Delano), furniture
 and crockery, 173 Main
 Sanford Henry W., carpenter F Mach Co., h 50 N Maple c Myrtle, F
 Saunders James, emp B Bros & Co., bds Holyoke c Williams
 Sauter Christian, cutler, h Cutlery blk, Bay State
 Sauter Jacob, cutler N Cutlery Co., h Maple, Bay State
 Sawin Andrew T., clerk C R R R, h 15 Hawley
 Sawtelle Henry O., mason, bds 77 Elm
 Sawyer Amos, soap manufacturer, Locust, Florence, h do
 Sawyer George W., rem to Springfield
 Sawyer Hiram E., carpenter emp C R R R, h 11 Williams

- Sawyer Sereno F., emp Amos Sawyer, h N Elm n Spring
 Scanlan James, emp F Mach Co., bds Bridge, Florence
 Scates D. W. C., insurance agt, h 62 King
 Schadee Ferdinand, photographer (Hardie & Schadee), h High, F
 Schadee Henry, ornamentor and painter, h Chestnut c High, Florence
 Schillare A. J., photographer, 108 Main, h Cherry c Pine
 Schillare David, emp N Silk Co., h High, Leeds
 Schillare David, Jr., carpenter, h High, Leeds
 Schmitter Ernest, emp B Bros & Co., bds 14 River
 Schmitter Moritz, emp B Bros & Co., h 14 River
 Schneider Fred., cutler N Cutlery Co., h Norwood av, Bay State
 Schneider Gustave, emp N Cutlery Co., h Paper Mill road
 Schuler Louis N., clerk William Gerhard, bds Maple, Florence
 Schultz Charles, emp B. Bros & Co., bds 33 Pleasant
 Schwille Frank J., overseer L. J. Warner's silk mill, bds Mill, B State
 Schwille John, farmer, h Mill, Bay State
 Scott Bell Miss, emp B Bros & Co., bds 20 Elm
 Scott David (Vernon Bros & Co.), res New York
 Scott James, emp W Mfg Co., bds Easthampton
 Scott Martin L., physician, Masonic n Center, h do
 Scully William, laborer, h Lake, Florence
 Scully William J., emp B Bros & Co., bds Kirkland av
 Searle Abner S., farmer, h Pine Grove
 Searle Charles M., farmer, h Pine Grove
 Searle Emerson, farmer, h Pine Grove
 Searle George E., farmer, Pine Grove
 Searle James H., (Searle & Edwards), h 45 Market
SEARLE & EDWARDS, (James H. Searle, Robert E. Edwards),
 furniture dealers and undertakers, Center r First church. See
 back cover
 Sears Herbert S., emp M. L. & M. W. Graves, bds 31 West
 Sears Laura E., widow Edwin, h 23 West
 Sears Nathaniel, h 25 Gothic
 Sears Patrick, emp H. Williams, bds 10 River
 Sears R. H. Mrs., h 21 Pleasant
 Sears Robert, laborer, h King
 Secor Peter D., barber, emp 97 Main, bds Cottage Place
 Seegar Augusta Miss, h College av
 Seegar Eliza Miss, h College av
 Seeley Sophia J. Miss, bds 19 West
 Seelye L. Clark, president Smith College, h Elm
 Seidell Charles, emp N Cutlery Co., h Main, Bay State
 Seidell Charles, rem to Springfield
 Seidell George, rem to Springfield
 Seidell John P., emp N Cutlery Co., h Main, Bay State
 Selectmen's office, Town Hall
 Semmiman Louis, brick maker, h Pine, Florence
 Sempter Charles, emp N Cutlery Co., bds Main, Bay State
 Sempter Kate Mrs., h Main, Bay State
 Sergeant George H., book keeper N E Wheel Co., h 20 Bridge
 Sessions Carrie A., widow Arthur L., h Crafts av

- Sessler Casper, rem to New York
 Seymour Christopher, physician 102 Main, h 25 Elm
 Seymour Mary A. Miss. clerk 72 Main, bds Center av
S HADY LAWN, MENTAL AND GENERAL SANITARIUM,
 Dr. Austin W. Thompson, prop, Gothic. [See contents.]
 Shaley Johanna Miss, bds Main n Nonotuck, Florence
 Shannon Catherine, widow, h Water, Leeds
 Shannon James, engineer N Silk Co., h South, Florence
 Shannon James A., tape mfr, Smiths Ferry, h do
 Shannon John, emp N Cutlery Co., bds Water, Florence
 Shannon Luke, watchman, Water, Florence
 Shannon Thomas, blacksmith W. S. Hartwell, bds South, Florence
 Sharkey Edward, emp E. N. Foote & Co
 Sharkey Thomas, engraver, emp E. N. Foote & Co
 Shaughnessey James, emp N Cutlery Co., h Federal, Bay State
 Shaughnessey Joseph, bds Maple, Bay State
 Shaughnessey Mary, widow Lawrence, h Maple, Bay State
 Shaw Anson, emp Casket Shop, h 72 N Maple, Florence
 Shaw Daniel N., rem to Springfield
 Shaw Francis, emp S. Parsons, bds 109 South
S HAW GEORGE W., veterinary surgeon at Dickinson & Pomeroy's stable, res South Amherst. [See p 281.]
 Shaw William, moulder B. M. Couch, h 24 Main, Florence
 Shay John J., rem to Warren, Mass
 Shea Bridget, widow Patrick, h River, Florence
 Shea Ellen, widow Dennis, h King ab Spring
 Shea James, cutler N Cutlery Co., h High, Bay State
 Shea James, h Hinckley, Bay State
 Shea John, laborer, h Hinckley, Bay State
 Shea John J., painter, emp John Tyler, h Center av
 Shea Kate Miss, emp N Silk Co., bds Bridge, Florence
 Shea Kate Mrs., h High, Bay State
 Shea Mary, widow Patrick, h Hospital Hill
 Shea Mary, widow Lawrence, h West, Florence
 Shea Michael, emp N Cutlery Co., h Cutlery blk, Bay State
 Shea Michael, laborer, h Franklin
 Shea Michael, laborer, h r N Elm
 Shea Michael, cutler N Cutlery Co., h Cutlery blk, Bay State
 Shea Patrick, bds 21 State
 Shea Peter, moulder F Mach Co., h Bridge, Florence
 Shea Thomas, laborer, h Mill Yard
 Shea Thomas, grocer, fish and oyster dealer, 195 Main, h State n Park
 Shea William laborer, h Bridge, Florence
 Shea William H., baker, emp Lyman & Shipman, h Mill, Bay State
 Shea William J., hostler Dickinson & Pomeroy, h 21 State
 Shearn Charles, foreman spinning dept B B & Co., h 22 Cherry
 Shearn Frederick C., overseer N Silk Co., bds Front, Leeds
 Shearn Joseph, supt sewing silk dept N Silk Co., h Roberts Meadow road, Leeds
 Sheehan Daniel, laborer, h 37 Williams
 Sheehan Mary, house keeper W Herrick, King

- Sheehy Robert, mechanic N Cutlery Co., h West, Florence
 Sheffield Emily K. Mrs., h High, Florence
 Shepard Albert A., h 2 Pine, Florence
 Shepardson Frank E., emp J. J. Hathaway, bds 83 South
 Shepardson Thomas J., carpenter, h 58 N Maple, Florence
 Shepherd Henry, h 16 Bridge
 Shepherd Thomas M., bds 16 Bridge
 Sheridan Edmund, emp N Cutlery Co., h Hinckley, Bay State
 Sheridan Thomas, emp N H & N Co., h Nonotuck, Florence
 Sherman Rachael, widow Austin, bds Fort
 Sherrette Esplain, emp E. N. Foote & Co
SHERWIN ABRAHAM, clothier, hats, caps, boots, and shoes, 18
 Main, h 16 do. [See front cover.]
 Sherwin Lillie Miss, bds 18 Nonotuck, Florence
 Sherwood Charles E., machinist N E Wheel Co., bds River road, L
 Shipman Charles E., (Lyman & Shipman), h Center
 Shumway Albert W., (Shumway & Riley), h Park, Florence
 Shumway Brainard, rem to New Britain
 Shumway E. M., rem to South Hadley
 Shumway Frank E., tinner Shumway & Riley, h Park opp W Center, F
 Shumway Fred S., painter, h Walnut
 Shumway Orrin B., foreman winding dept, B B & Co., bds 45 Pleasant
 Shumway & Riley, (A. W. Shumway, Joseph Riley), stove dealers,
 plumbers and pipers, Park c Meadow, Florence
 Siegler Jacob, silk dyer, h Main, Florence
 Sikes Jerome B., carpenter, h North opp Lincoln av
 Simonds Hannolina, widow Samuel, bds 5 Fruit
 Simonds Kittie Miss, teacher, rooms N Main, Florence
 Simonds Martha E. Mrs., bds W Center, Florence
 Simpson David, laborer, h Bates
SIMPSON J. B., concrete and asphalt paver, office Mansion House.
 Home office Newton, Mass. [See p 281.]
 Simpson Samuel, teamster M. L. & M. W. Graves, h Prospect
 Simpson William, rem to Philadelphia, Pa
 Singleton William, emp N Silk Co., h River road, Leeds
 Skiff George W., laborer, h r 36 South
SKIFF JAMES M., jeweler 119 Main, h 117 do. [See p 255.]
SKILTON A. M. MRS., crockery, paper hangings, &c., 15 Pleas-
 ant, h 28 King. [See p 251.]
 Skilton O. A., rem to Dakota
 Skinner James, painter, bds 11 River
 Slate Catherine, widow Erastus, h 3 Phillips Place
 Slattery Bridget Mrs., emp M R B Co., bds Main, Leeds
 Slattery John, emp E. N. Foote & Co., bds 1 Masonic
 Slattery John T., emp M R B Co., h Main, Leeds
 Slattery Rody, emp M R B Co., h Florence, Leeds
 Slattery Timothy J., cigar manufacturer 179 Main, h 177 do
 Slattery William, laborer, h Hinckley
 Sleuman Niles A., farmer Mrs. H. B. Hoxie, bds Roberts Meadow
 Smallshaw Sarah A., widow, bds High, Bay State

- Smith Abram, silk weaver, bds 33 Pleasant
 Smith Adeline P., widow Ebenezer, h Meadow, Florence
 Smith Alexander, rem to New York
 Smith Alvah T., h 11 Elm
 Smith Alfred, rem to Springfield
 Smith Ansel W., laborer, h Clement
 Smith Asa, pres Conn River Lumber Co., res Hartford
 Smith C. Butler, carpenter, h 17 N Main, Florence
 Smith Carrie S. Miss, seamstress, bds 35 Bridge
S MITH CHARITIES, Luther Bodman pres of trustees, Main n
 King
 Smith Charles, (Smith & Prindle), h 204 Main
 Smith Charles, rem to Minnesota
 Smith Charles, h 40 King
 Smith Charles H., vinegar mfr, Smiths Ferry, res Holyoke
 Smith Charles S., painter emp John Tyler, h Maple
 Smith Charles O., broom handles, h 8 Union
 Smith Clarence A., emp F Mach Co., rooms fire dep't building
 Smith College, junc Elm and West
 Smith Daniel, rem to Springfield
 Smith Edgar L., painter, h Main, Florence
 Smith Edward C., harness maker, emp H. P. Smith 165 Main, h 1
 Clark av
 Smith Edward M., baker S. Carr, bds 39 Prospect
 Smith Edward H., machinist, bds 8 North
 Smith Emerson J., farmer, h Smiths Ferry
 Smith Estelle, emp L. J. Warner, bds Elm n silk mill
 Smith Eveline S. Mrs., boarding house 10 River
 Smith Francis A., farmer, h West Farms
 Smith Frank E., machinist, h Center, Florence
 Smith Frank D., rem to Springfield
 Smith Frank H., bds 35 South
 Smith Fred P., emp W Mfg Co., h Lincoln av
 Smith Eliza, widow George, h 26 Center
 Smith George E., painter, h 55 Gothic
 Smith George F., laborer, h Olive
 Smith George H., (W. L. Smith & Co.), h 261 Main
 Smith George T., emp C Emery Wheel Co., h 27 Vernon
 Smith Henry B., laborer, h 109 South
 Smith Henry C., engineer emp M. L. & M. W. Graves, h 8 North
 Smith Henry E., broom manufacturer Strong av n Conn R R depot, h
 18 Pomeroy Terrace
 Smith Henry M., (Smith & Livermore) Center, h 12 Franklin av
 Smith Henry P., harness maker 165 Main, h 35 South
 Smith Herbert C., clerk 7 Pleasant, bds North head Lincoln av
 Smith Herman, h 10 Pine, Florence
 Smith Hervey J., printer emp HAMPSHIRE GAZETTE, h 39 Prospect
 Smith H. W., farmer, bds Summer c State
 Smith James E., clerk Cutler, Plimpton & Co., h Maple, Florence
 Smith Jennie D. Miss, clerk Register of Deeds office, bds 12 Bridge
 Smith John, laborer, bds Chestnut

- Smith John, emp N S Co., h Bridge Florence
 Smith Joseph L., emp B Bros & Co., h 26 Hawley c Holyoke
 Smith Josiah W. Mrs., h 12 Bridge
 Smith Levi W., lock corner packing boxes Pleasant, h Summer c State
 Smith Lizzie M. Miss, clerk, bds Crafts av
 Smith Louisa C., h 35 Bridge
 Smith Lucy B., widow Hervey, h Smiths Ferry
 Smith Lucy E. Miss, teacher Greek 17 Elm, bds do
 Smith Mabel Miss, clerk H. R. Staplin, bds 8 Maple
 Smith Mark, laborer, bds Roberts Meadow
 Smith Mary D., emp A. Kingsbury, bds 169 Main
 Smith Mary L., widow Hiram, h Crafts av
 Smith Mary R., widow R B., h N Main, Florence
 Smith Martin, carpenter, h Lincoln av
 Smith Marvin, physician Maple, Florence, rooms do
 Smith Milo J., farmer, h Smiths Ferry
 Smith Milo L., farmer, h Smiths Ferry
 Smith Milo W., farmer, h Smiths Ferry
 Smith Omer M., foreman finishing dept N S Co., h Meadow, Florence
 Smith Owen, laborer, h 5 Chestnut
 Smith Peter, emp B Bros & Co., bds Kirkland av
 Smith Rodolphus, broom mfr 22 Washington av, h do
 Smith Rosa Miss, h Beacon n Pine, Florence
 Smith Ruth M. Miss, bds Main n Holyoke, Florence
 Smith Samuel, emp Eames & Sprague, h 23 King
 Smith Silas M., h 6 Hawley
 Smith Sophia C. Miss, dress maker 169 Main, h do
 Smith Sylvanus, engineer Day Bros., Easthampton road
 Smith Thomas, barber 78 Main, rooms do
 Smith Thomas, brick mason, h Franklin n Prospect
 Smith Warner S., clerk, bds Haydenville
 Smith Watson L., (W. L. Smith & Co.), h 14 Phillips Place
 Smith Wilbur, farmer, h Smiths Ferry
 Smith William, hostler, rem to Springfield
 Smith William C., brakeman, bds 12 River
 Smith William D., carpenter, h 43 South
 Smith William E., canvasser, h Leonard c Front, Leeds
 Smith William M., jeweler Davis blk Main, h Meadow, Florence
 Smith Willie R., clerk Sam'l Wilder bds N Main, Florence
- S MITH W. L. & CO.**, (Watson L. Smith, George H. Smith), furniture dealers and undertakers, 8 to 11 Court. [See inside of front cover.]
- S MITH & LIVERMORE**, (Henry M. Smith, Orrin E. Livermore), carpenters, builders and lumber dealers, Center. [See p 270.]
- S MITH & PRINDLE**, (Charles Smith, Josiah H. Prindle), clothiers and merchant tailors 68 Main. [See p 252.]
- Snell Alden T., baggage master, h 5 River
 Snell Annie G. Miss, clerk 72 Main, bds 5 River
 Snell Frank W., brakeman, bds 5 River
- S NOW C. ASHLEY**, propr Star Printing House, Main c Hawley, rooms 78 Main. [See p 246.]

- Snow Belle F. Mrs., h Henshaw av
 Snow Charles W., surveyor C R L Co., bds 90 South
 Snow Edwin M., mechanic N E Wheel Co., h River road, Leeds
 Snyder Augustus, cutler, h Federal n Vernon
 Sobotky Peter, clothier 6 Main, h State c Bright
 Soucie William, teamster, h N Prospect
 Souter William, supt spun silk dept N S Co., h Center c Grove, Leeds
 Southwick Elbridge G., commercial traveler Belding Bros & Co., h
 Henshaw av
 Sparber Emil, rem to Greenfield
 Sparks Dwight, farmer, h W Farms
 Spat John, h Union, Bay State
 Spaulding Mark H., office 36 Main, h State c Spring
 Spaulding Susan Mrs., bds 9 Elm
S PAULDING TIMOTHY G., lawyer Main over N I for Savings,
 rooms 20 Elm. [See p 242.]
 Spear George L., emp F Mach Co., h Massasoit
 Spear Lizzie P. Mrs., h 39 Prospect
 Spear Louis J., clerk 101 Main, bds Summer c State
 Spelman Eugene, laborer, h Nonotuck, Florence
 Spencer William H. Rev., resident speaker Free Cong Society, h Lilly
 n Meadow, Florence
 Sperbeck William H., painter, h N King
 Sperling William H., painter, emp C. H. Jones, h North
 Spiro Ivan, traveling salesman N Pocket Book Co., bds Mansion House
 Spooner Charles E., rem to Springfield
 Sprague Elizabeth Mrs., bds 14 Bridge
 Sprague Stephen D., (Eames & Sprague), h 14 Bridge
 Spring Charles E., foreman finishing room W Mfg Co., h 29 South
 Springen John, emp Florence Tack Co., bds South, Florence
 Springer John, hardware, agricultural tools, &c., 30 Main, h Bright
 Squires Jerry W., laborer, h Locust, Florence
 Staab Jacob, emp B Bros & Co., h 40 Market
 Stack James, emp Clement Cutlery Co., h Hospital Hill
 Stack Patrick emp N H & N Co., bds Prospect c Lawn av
 Stadter John, farmer, bds Coles Meadow
 Stadter Peter, farmer, h Coles Meadow
 Stall Fred E., silk worker, h 12 Maple, Florence
 Stanley Francis W., clerk 60 Main, bds Round Hill Hotel
 Stannard David C., rem to Holyoke
 Stapleton James, gardener, h Winter
 Staplin Henry R., milliner, 157 Main, h 161 do
STAR PRINTING HOUSE, C. A. Snow prop, printer and lith-
 ographer Main c Hawley. [See p 246.]
 Starkweather Charles G., farmer, h 36 South
 Stebbins Hiram, farmer, h W Farms
 Stedman Rebecca N., widow William S., h 14 King
 Stedman William S., bds 14 King
STEELE ALFRED E., manager Tigerite Mfg Co., office 34 Main,
 h 37 Washington av.
 Steele Charles W., clerk Tigerite Mfg Co., h 14 Franklin

- Steete George, emp Clapp's saw mill, bds 78 South
 Steiner George, emp L. J. Warner, bds Elm n silk mill
 Stephenson Martha E., housekeeper 14 Maple, Florence
 Stevens Charles E., treas Crvstal Emery Wheel Co., h 9 North
 Stevens Clara Miss, rem to Hartford
 Stevens Edward A., machinist, h 32 Vernon
 Stevens Irene Mrs., bds Main, Bay State
 Stevens Josiah, mechanic, h 13 Park, Florence
 Stevens Nellie Miss, rem to Hartford
 Stevens William H., blacksmith Loudville, h do
 Stevens William J., rem to New York
 Stevenson George, mechanic F Mach Co., h Chestnut, Florence
 St. Germain Isaac, broom maker, h King
 Still William, rem to Holyoke
S **TIMPSON C. N.**, pianos and organs 52 Main, res Westfield. [See front cover.]
 Stimpson Sarah A., widow Charles, h 40 King
 St. Jacques Paul, broom maker, h King
 St. John Edmond, emp N Silk Co., h West, Florence
 St. John's Episcopal Church, Bridge n Market
 St. John E. Lee, clerk G. L. Loomis, h Bank av, r First Nat'l Bank
 Stockbridge Edwin A., engineer F Tack Co., h Locust n Holyoke, F
 Stockbridge Mary Mrs., bds 7 King
 Stockbridge Roderick B., tack maker F Tack Co., h Holyoke F
 Stocker Alfred H., (A. H. Stocker & Co.), bds 20 Bridge
S **STOCKER A. H. & CO.**, (Alfred H. Stocker, Albert H. Willis), gents furnishing goods, hats, caps, &c., 96 Main. [See p 251.]
 Stocking George, mechanic, h 23 Center, Florence
 Stockwell Austin H., painter, h N Farms
 Stockwell Calvin, farmer, h W Farms
 Stockwell David, farmer, h W Farms
 Stockwell Erastus Mrs., h W Farms
 Stockwell Frederick A., clerk Edwards Bros., h 26 King
 Stockwell Frederick A. 2d, farmer, h W Farms
 Stockwell Hamlin W., farmer, h W Farms
 Stockwell John, farmer, h W Farms
 Stockwell Lewis, farmer, h W Farms
 Stockwell Oren, farmer, W Farms
 Stoddard Francis H., sec G Mfg Co., h 24 Elm
 Stoddard F. H. & Co., mfrs of marking pens, r 7 King
 Stoddard John T., professor of chemistry, Smith College, h 18 King
 Stoddard Peter, farmer, h Coles Meadow
 Stoddard William H., h 14 Elm
 Stone Bradshaw H., supt highways, h 72 State
 Stone Frank H., clerk Maine Bros., h Maple, Florence
 Stone Harriet Mrs., h Union c Pine
 Stone Isaac, lawyer, office 112 Main, h 74 Elm
 Stone James, emp F Mach Co., h 45 Main
 Stone Jane Mrs., h Elm n Brick Yard
S **STONE JOHN Q.**, dentist 3 Union blk 38 Main, bds 59 South.
 [See p 244.]

Stone Kirk H., book keeper G. L. Loomis & Co., bds 72 State
 Stone Tillis, barber, emp basement Mansion House, h Perkins av
 Storer Oran, selectman, bds Florence House, Florence
 Story Edwin B., music teacher, h 18 Elm
 Stowell A. Mrs., h Fruit, Florence
 Stowell Edward C., h Grant av
 Strang James, emp Clement Cutlery Co., bds Hinckley, Bay State
 Strang Patrick, emp F Mach Co., bds Hinckley, Bay State
 Straw Frank, silk worker N Silk Co., bds High, Bay State
 Straw Henry, silk worker, N S Co., bds High, Bay State
 Straw William, silk worker N S Co., bds High, Bay State
 Stredo Clifford, emp Day Bros., h 100 South
 Street William, prop Eyrie House, Mt. Tom
 Streeter Philander A., carpenter, h Smiths Ferry
 Strickland William P., attorney-at-law and judge Dist Court 46 Main,
 h 11 Phillips Place
 Strong Alanson L., laborer, h West n South
 Strong Allen L., farmer, bds 92 South
 Strong Andrew J., moulder, emp C. E. Clapp, h 89 South
 Strong Arthur P., machinist B. M. Couch, bds 10 Williams
 Strong Bela, gardener, h College av
 Strong Calvin, farmer, h 56 South
 Strong Cephas, farmer, h 16 North
 Strong Daniel, farmer, h 29 Vernon
 Strong Delia A. Miss, bds Elm c Massasoit
 Strong Dwight D., carpenter, bds West n South
 Strong Ebenezer, farmer, h Center c Masonic
 Strong Edward B., farmer, h 16 North
 Strong Edward P., farmer, bds 92 South
 Strong Elisha, farmer, h 38 South
 Strong Ernest E., foreman finishing dept Damon Narrow Fabric Co.,
 h College av
 Strong Elihu, h r 7 Park
 Strong E. S., widow David, h 41 Market
 Strong Albertnah M., widow E. W., h Hospital Hill
 Strong Francis, grist mill Loudville, h do
 Strong George, farmer, h 92 South
 Strong Henry, rem to Hartford
 Strong Jennie Miss, dressmaker, bds 33 South
 Strong Jonathan, farmer, h 54 South
 Strong Jonathan, Jr., farmer, bds 54 South
 Strong Julius, farmer, h Hospital Hill
 Strong Morris, h 10 North
 Strong Melissa, widow Harvey, bds 33 South
 Strong Patrick, h Hinckley, Bay State
 Strong Samuel B., farmer, bds 56 South
 Strong Sarah L. H., widow Charles, h Nonotuck, Florence
 Strong Sidney, h Elm n silk mill
 Strong William, farmer, h 10 Williams
 Strong Wm. H., farmer, bds 10 Williams
 Strong William H., truckman, h Grant av

- Strong William L., laborer, bds 45 South
 Sullivan Bridget, widow Patrick, h 62 Pleasant
 Sullivan Bridget Miss, emp G. Mfg Co., bds 30 Maple, Florence
 Sullivan Charles M., clerk 15 Pleasant, bds 34 King
 Sullivan Daniel, miller, emp M. L & M. W. Graves, h King
 Sullivan Dennis, emp W Mfg Co., h 37 Williams
 Sullivan Edward, laborer, h Haydenville road, Leeds
 Sullivan Ellen, widow John, h Hospital Hill
 Sullivan Eugene, farmer N L Hospital, h Hospital Hill
 Sullivan James, h Main, Leeds
 Sullivan James P. Jr., emp N Emery Wheel Co., h Main, Leeds
 Sullivan Jerry, laborer, h Cemetery road
 Sullivan John, laborer, h Prospect
 Sullivan John rem to Holyoke
 Sullivan John, laborer, h Mill Yard
 Sullivan John, bds Hospital Hill
SULLIVAN JOHN A., town clerk, flour and grain dealer, ferti-
 zers, agricultural tools &c., Main opp N H & N Co depot, h 34
 King. [See outside back cover.]
 Sullivan John C., laborer, h Chestnut
 Sullivan John D., emp W Mfg Co., h Front
 Sullivan Joseph M., rem to Easthampton
 Sullivan Julia, widow John H., h Front
 Sullivan Mary, widow Daniel, h Hospital Hill
 Sullivan Mary, widow Cornelius, h Front n Williams
 Sullivan Matthew, emp W Mfg Co., h Fort
 Sullivan Michael, laborer, h 41 Williams
 Sullivan Michael, mason, North Prospect at R R crossing
 Sullivan Patrick, ice peddler, h Hospital Hill
 Sullivan Patrick, laborer, bds Main, Leeds
 Sullivan Patrick, painter, State ab Spring, h do
 Sullivan Patrick W., painter, office 90 Main, h Walnut c Pine
 Sullivan Peter, laborer, emp W. D. Clapp, h Pleasant
 Sullivan Peter Mrs., h Mill Yard
 Sullivan Sol., laborer, h N Elm
 Sullivan Timothy, emp N Cutlery Co., h Spring, Florence
 Sullivan Timothy, laborer, h Mill Yard
 Sutton Hannah M. Miss, teacher Kindergarten, bds Maple, Florence
 Sweeney Charles, carpenter, h Meadow n Bridge
 Sweeney Mary, widow Dennis, h River, Florence
 Sweet A. H., emp casket shop, bds High n Fruit, Florence
 Sweet Joseph, rem to Indian Orchard
 Sweet Joseph, Jr., cotton worker, h Nonotuck, Florence
 Swift Henry, (Henry Swift & Son), h Myrtle, Florence
 Swift Henry & Son, masons and builders, Myrtle, Florence
 Swift James I., emp F Mach Co., bds Myrtle, Florence
 Swift John A., (Henry Swift & Son), bds Myrtle, Florence
 Swift Parentha, widow William, bds South c Clark
 Swift William H., clerk E. S. Ross, bds River road, Leeds
 Sydell Andrew G., emp N Silk Co., h Water, Leeds,
 Sylvester Arthur K., farmer, bds Roberts Meadow

Sylvester Eli A., farmer, h Roberts Meadow
 Sylvester Frank A., farmer, bds Roberts Meadow
 Sylvester Holland D., foreman M R B Co., h Chesterfield road, Leeds

TACY ABRAM, carpenter, h Chesterfield road, Leeds
 Tacy Edward, emp N Silk Co., h Water, Leeds
 Tacy Eldrich, emp N Silk Co., h Water, Leeds
 Tacy Henry, emp N Silk Co., h Reservoir road, Leeds
 Tacy Joseph, shoemaker Water, Leeds, h do
 Tacy Lewis, emp N Silk Co., h Grove av, Leeds
 Tandy James, bds Amos Sawyer, N Elm
 Tardiff Felix, carpenter, h 32 Market
 Tardiff Joseph, emp W Mfg Co., bds 32 Market
 Tardiff Peter, emp W Mfg Co., h 10 Market
 Tardy John, laborer, h Ox Bow
 Tardie William, emp C R L Co., h Mt. Tom
 Tate James, gardener E. H. R. Lyman, h South
 Tatro E., carpenter, bds Kirkland av
 Tatro Waldro, carpenter, h West n iron bridge
 Taynton Thurza Mrs., widow, h Park n Main, Florence
 Taylor Clarence E., peddler, bds 61 South
 Taylor Frank H., student, rooms 114 Main
 Taylor George W., farmer, Bridge n Water
 Taylor Hiram, railroad contractor, h 26 Maple
TAYLOR ISAAC N., livery and sale stable, 15 Masonic, h do.
 [See p 282.]
 Taylor Isaac N. Jr., bds Masonic
 Taylor James, h Water, Florence
 Taylor Jane Mrs., h Florence, Leeds
 Taylor John T., emp N Cutlery Co., h Water, Florence
 Taylor Lucy B., widow J. S. D., h 55 Elm
 Taylor Matilda, widow Frank, bds South n Brick Yard
 Temple Edward L., emp N Paper mill, h Mill, Bay State
 Temple Susan P., widow Henry D., h King
 Templeton John, emp B Bros & Co., h Holyoke c Hawley
 Tenney M. S., widow Lionel, h 11 Elm
 Terrill Almon B., emp N Silk Co., h 21 Chestnut, Florence
 Terrill Bridget Miss, h Nonotuck, Florence
 Tetrault Augustine, laborer, h Water, Leeds
 Teweles Louis, machinist B B & Co., h 20 Market
 Thayer Alfred M., carpenter, h High n Chestnut, Florence
 Thayer Arthur L., clerk post office, h Kirkland av
 Thayer A. W. Mrs., h 2 West
 Thayer Caleb L., tobacco dealer, h 10 Franklin av
 Thayer Caroline Miss, seamstress, rooms 13 Maple
 Thayer Ebenezer W., butcher, h Myrtle c State
 Thayer Fred., laborer, bds Hospital Hill
 Thayer George D., physician 92 Main, rooms do
 Thayer Henry M., clerk D. J. Wright, h Summer c State
 Thayer John, laborer, h 16 Walnut
 Thayer Justin, machinist W. Herrick, bds Summer

Thayer Morris P., milk peddler, h 10 Washington Place
 Thayer Samuel M., carpenter, emp C. S. Crouch, bds 30 Maple, F
 Thayer Julia A., widow S. H., h 20 Summer
 Thayer Warren W., rem to Chicopee
 Thayer Wellington R., clerk M. W. Jackson, h 19 Vernon
 Thibodeau Gregory, emp N Silk C., h Water, Leeds
 Thibodeau Joseph, emp W Mfg Co., h 13 State
 Thomas E. G., rem to Detroit, Mich
 Thomas Peter, farmer, h West Farms
 Thompson Arthur, emp L. J. Warner, bds Elm n silk mill
T **THOMPSON AUSTIN W., DR.**, proprietor and supt Shady Lawn
 Mental and General Sanitarium, Gothic, h do.
 Thompson Ellen E. Miss, teacher French and German 17 Elm, bds do
 Thompson Frank B., plumber W. F. Prindle, h Bates
 Thompson Frank L., wire drawer, h Kirkland av
 Thompson George F., farmer, bds W Farms
 Thompson John P., superintendent C R L Co., h 16 Hawley
 Thompson Mary S. B., widow Daniel, h Round Hill
 Thompson Nathaniel, blacksmith, emp Laframboise & Dragon, h
 State n R R track
 Thompson Rhoda Mrs., h W Farms
 Thorne Anna O. Mrs., h 5 Maple
 Thorpe John C., farmer, Smiths Ferry
 Thorpe J. Rodney, farmer, Smiths Ferry
 Thorrington A. N., turnkey at jail, bds do
 Thurston Kirk J., book keeper, rem to Easthampton
 Tierney Michael, laborer, h 5 Holyoke
T **TIGERITE MFG. CO.**, A. E. Steele, manager, jobbers of jewelry
 and fancy goods, 34 Main. [See p 238.]
 Till Edward, hostler J. L. Draper, rooms r Carr's block
 Tillotson William, clerk D. J. Wright, h North
 Timothy Thomas, gardener, h West n iron bridge
 Timothy William, driver Wm. McCandless, bds West
 Tisch A., clothier 42 Main, h 27 Pleasant
 Tisch Morris, clothier 42 Main, h 27 Pleasant
 Tisdell Thomas, carpenter, h 20 River
 Titcomb Sarah E. Miss, h 28 N Main, Florence
 Titcomb William H., carpenter, h 28 N Main, Florence
 Tobin John, laborer, h Bridge road
 Tobin Josie Miss, waiter Mrs. M. K. Olney, bds 145 Main
 Tobin Mary, widow Edward, h College av
 Tobin Michael, night watchman G Mfg Co., h Landy av, Florence
 Tobin Michael, emp N Cutlery Co., h off West, Florence
 Todd J., widow Iru, h Roberts Meadow
 Todd John R., farmer, h Roberts Meadow
 Todd Julia Miss, bds 1 Hawley
 Todd Sarah Miss, bds 1 Hawley
 Toohey James Mrs., cook Hampshire House
 Toohey John, laborer, h Mill Yard
 Toohey Patrick, laborer, h 48 Williams
 Toohig Jerry, laborer, h Nonotuck, Florence

Toomey James, hostler, emp J. L. Draper, rooms over stable
 Torpey Maurice, mechanic, h Oak, Florence
 Torrey Calvin, shoe maker, Main, h Front, Leeds
 Torrey Emerson M., carpenter, h 58 N Maple, Florence
 Torrey Harlan W., rem to Hartford, Ct
 Torrey Job, farmer, h 74 N Maple, Florence
 Torrey Philena, widow Henry, bds Factory
 Torrey Rose, emp L. J. Warner, bds Elm n silk mill
 Tourney James, hostler J. L. Draper, rooms do
 Tower Clinton B., farmer, h Haydenville road, Leeds
 Tower Fred L., machinist, bds Hockanum road
 Tower Jetson A., rem to Cummington, Mass
 Tower Walter M., carpenter N. L. Hospital, h Hospital Hill
 Tower Wesley W., emp M R B Co., h Main, Leeds
 Tower Willis F., emp N Silk Co., bds Center n Chestnut, Leeds
 Towhill Jerry, brick layer, h Hinckley
 Towhill Patrick, laborer, h Warner, Bay State
 Town Hall, Main c Crafts av
 Towne Byron L., (J. M. Towne & Sons), h 28 Main
 Towne Edgar J., (J. M. Towne & Sons), h Washington av n Elm
 Towne Jacob W., h Pine
 Towne Joseph M., (J. M. Towne & Sons), h 11 Franklin
TOWNE J. M. & SONS, (Joseph M., Edgar J., Byron L. Towne,)
 I grocers 201 Main. [See p 259.]
 Townend Arthur, rem to Haydenville
 Townend Emma B. Miss, bds 10 Center, Florence
 Townend Harry G., clerk Smith Charities, bds 10 Center, Florence
 Townend Henry, engineer F Mach Co., h Center, Florence
 Townend Shelley K., teacher, bds 10 Center, Florence
 Tracy Carlos C., book keeper Amos Sawyer, h Paradise road
 Tracy Fanny Mrs., bds High, Florence
 Train Elva A. Miss, emp J. J. Hathaway, bds 83 South
 Train Orson E., emp J. J. Hathaway, h 83 South
 Trask George E., rem to Orange, Mass
 Trask William H., clerk 42 Main, bds Nonotuck House
 Treat Charles, emp B Bros & Co., bds 8 Hawley
 Treat Osborn, emp B Bros & Co., bds 8 Hawley
 Trickey Maggie Miss, domestic, Mansion House
 Trost Frank, painter h Meadow n Bridge
 Trotter Leander, laborer, h Lincoln av
 Troup Thomas, laborer, bds Smiths Ferry
 Trow William M., physician, 104 Main, h 29 Pleasant
 Troy Edward, emp N Cutlery Co., bds Cutlery blk, Bay State
 Truehard Joseph, h Hospital Hill
 Truehard Paul, laborer, h Hospital Hill
 Trumbull James R., h Prospect c Park
 Tucker George (Graves & Tucker), h Main c West
 Tucker Lydia M., Mrs., h 26 Elm
 Tunncliffe Eliza, widow William, intelligence office Myrtle c State,
 Tunncliffe Mary, widow John, h Florence, Leeds
 Tunncliffe William C., machinist, bds Florence c Critchlow, Leeds
 h do

Turner Lydia M., widow Elisha, h West
 Turner John M., ins and real estate agent and broker, 112 Main, h 5
 Phillips Place
 Turner Walter A., cutler N Cutlery Co., h Maple, Bay State
 Turney Michael, teamster, h Holyoke
 Tuttle Charles, mechanic, bds 74 Pleasant
 Twiss Edward W., foreman foundry F Mach Co., h Chestnut ab R R,
 Florence
 Twiss Frank W., contractor F Mach Co., h Hockanum road
 Twiss Horace, Mrs., h Hockanum road
 Twiss Marion E. Mrs., dress maker 62 Main, h Hockanum road
 Twitchell George A., emp F Mach Co., h High n Chestnut, Florence
 Tyler Frederick, bds 21 Pomeroy Terrace
 Tyler Henry M., professor of Greek, Smith College, h Prospect n Park
TYLER JOHN, painter and doors, sash and blinds, 134 Main, h
 South n Main. [See p 278.]
 Tyler Kate Miss, h King
 Tyler Luther E., engineer N Silk Co., h Main, Leeds

UNION COAL YARD, L. A. Clark, propr, 39 Pleasant and 131 Main
 United States and Canada Express, H. W. Dewey agt 26 Main, W. L.
 Wilcox agt N H & N depot, Florence, S. L. Bolter agt Leeds
 Usher Sarah, emp B Bros & Co., bds Center

VALENTINE EDWARD, mechanic, h N Main, Florence
 Valley Fruit Evaporator Co., fruit evaporators, R R Steam Mill, Main
 Vanslet Alfred, building mover. h 36 Williams
 Vanslike Cornelius S., emp F F Co., h 62 N Maple, Florence
 Vanslike Nicholas S., mechanic F Mach Co., h 8 Chestnut, Florence
 Vanslike Sepall, emp F Mfg Co., h 15 Prospect, Florence
 Ventor August, lithographer, bds Florence House, Florence
 Vernon Bros & Co., (Thomas Vernon, George R. Vernon, David Scott),
 proprs Northampton Paper Co., Paper Mill Village
 Vernon George R., (Vernon Bros. & Co.), res New York
 Vernon Thomas (Vernon Bros. & Co.) res New York
 Verselle Joseph, emp N Silk Co., h Water, Leeds
 Versew Henry, silk worker, h Water, Leeds
 Versew James, emp N Silk Co., h River Leeds
 Versew Joseph, spool turner N Silk Co., h Water, Leeds
 Versew Robert, rem to New York
 Vessie Robert, rem to Westfield
 Videtto John L., upholsterer, rooms 2 River
 Village Improvement Association 102 Main
 Vining Fred, carpenter, bds 10 River
 Vogel Arthur, designer M R B Co., h Florence n School House, Leeds
 Vogel John, farmer, h N Elm
 Vogel John Jr., teamster, h Paper Mill road
 Vogler John A., painter, emp John Tyler, h 113
 Volenger George, laborer, bds 48 Bridge
 Volenger Lawrence, emp H. W. Clapp, bds 78 South

Volker Louis H., emp E. N. Foote & Co., bds 32 Market
 Volle John, pocket book maker, h Summer

WACKFORD ALBERT E., telegraph operator C R R depot bds 4 Walnut
 Wackford John, cigar maker, emp C. N. Gabb, h 4 Walnut
 Wackford William, cigar maker, h 4 Walnut
 Wade Alfred, emp E. H. R. Lyman, h 81 South
 Wade Edward H., (Wade, Warner & Co.), h 4 North
 Wade Ellen N. Miss, compositor Hampshire County Journal, bds 4
 North

Wade George, wire drawer, h Cottage Place
 Wade John, silk dyer, h Pleasant n Williams
 Wade John, rem to Holyoke
 Wade Michael, dyer B Bros & Co., bds 23 Hawley
 Wade Thomas, laborer, bds Main, Leeds

WADE, WARNER & CO., (Edward H. Wade, Charles F. W ar-
 ner), publishers Hampshire County Journal and job printers,
 Jones block, Court. [See p 231.]

Wagner Henry, rem to Newark, N J

Wainwright J. Arthur, lawyer, (Hill & Wainwright), bds Prospect,
 Easthampton

Wainwright Robert, silk weaver, h 58 Bridge
 Waite Austin A., painter John Tyler, h Bridge n Water
 Waite Dennis, joiner, h N Main, Florence
 Waite George E., ice peddler, h Hospital Hill
 Waite George M., mason, h N Elm
 Waite M. A. Mrs., h 12 River

Waite Spencer, farmer, h North c Pine
 Waite S. C., carpenter, bds 8 River
 Walbridge Calvin C., carpenter, emp N Silk Co., h 3 West, Leeds

Walbridge Charles D., emp Clement Mfg Co., h 59 Elm
 Waldron Mary, widow Patrick, h South ab covered bridge
 Walker Charles H., laborer, h 76 South

Walker George H., (George H. Walker & Co.), h 23 Market

WALKER GEORGE H. & CO., (George H. Walker, Henry J.
 Walker), druggists, paints, oils, groceries, &c., 90 Main. [See
 p 256.]

Walker Henry J., (George H. Walker & Co.), h 1 Cherry

Walker Mary M. Miss, teacher English 17 Elm bds do

WALKER OLIVER, secretary and treasurer Hampshire Mutual
 Fire Insurance Co., insurance and real estate agent, 52 Main, h
 31 Pleasant. [See p 245.]

Walker Robert M., dyer, bds Hospital Hill

Wall John, emp N Cutlery Co., h Bridge, Florence

Wall Patrick, emp N Cutlery Co., h South, Florence

Wallace Bart, laborer, h Water, Florence

Wallace Christopher, h Lilly n Meadow, Florence

Wallace Edward F., barber and bath rooms 181 Main, rooms 20 King

Wallace Gideon S., joiner, h 56 Elm

Wallace Merritt, emp Casket shop, bds N Main, Florence

Wallace Merritt O., emp F Furniture Co., bds Lilly, Florence

- Wallace Michael, laborer, bds Water, Florence
 Wallace Thomas, h Water, Florence
 Walpole Frank, teamster M R B Co., h Main n Spring, Leeds
 Walpole Mary N., emp M R B Co., bds Main n Spring, Leeds
 Walpole Thomas, h Main n Spring, Leeds
 Walsh William, overseer N S Co., h Critchlow, Leeds
 Walsh William E., overseer N S Co., h Florence, Leeds
 Waltz Godfred, teamster P. Nutting, h Elm n Brick Yard
 Ward James, painter, h 15 Gothic
 Ward John G., laborer, h Bridge n Water
 Ward Margaret D., widow James C., h 44 Elm c Paradise road
 Ward Mary E., seamstress N L Hospital, bds do
 Ward Thomas, laborer, h Pine Grove
 Ware Arthur M., clerk M. H. Ware, h 24 Maple, Florence
 Ware Carrie Miss, waiter Mansion House
 Ware Moses H., meat market Maple, h 8 Center, Florence
 Ware Sylvester M., chair seater, h 5 Pleasant
 Warner A., widow John, bds 2 River
 Warner Allen C., ca. penter, emp Wm. J. Warner, h N Main, Florence
 Warner Charles F., (Wade, Warner & Co.), h 2 River
 Warner Edward, book keeper, bds Williams c Front
 Warner Edwin W., farmer, h Bridge road, Florence
 Warner Emeline R., widow Joseph, bds Elm opp silk mill
 Warner Frank D., wire drawer, bds 5 Clark av
 Warner George P., treasurer M R B Co., h Front, Leeds
 Warner Henry W., meat peddler, bds Florence, Leeds
 Warner John F., farmer, h N Main, Florence
 Warner John L., book keeper L. J. Warner, bds Elm
 Warner Lewis, cashier Hampshire County Bank and treas Hampshire Savings Bank, h 19 Pomeroy Terrace
 Warner Luther, carpenter, h N Main, Florence
WARNER LUTHER J., silk manufacturer, Elm near Florence line, h opp the mill. [See p 237.]
 Warner Moses, farmer, h Florence, Leeds
 Warner Seth S., agent, h N Main, Florence
 Warner Sheldon, h 13 N Main, Florence
 Warner William A., traveling salesman, h 5 Washington av
 Warner William J., carpenter and builder, h N Main, Florence
 Warnock Robert, emp Amos Sawyer, h Slaughter road
 Warren Charles H., emp R. M. Guilford & Co., bds Holyoke c Hawley
 Warren Charles L., farmer, h 5 Main, Florence
 Warren Ellen, widow Thomas, rem to Holyoke
 Warren E. M. & Co., (Miss Eva Warren, John M. Warren), milliners 56 Main
 Warren Eva M. Miss, (E. M. Warren & Co.), bds Hawley
 Warren Frank H., (R. M. Guilford & Co.), bds Holyoke c Hawley
 Warren John M., h 16 Hawley
 Warriner James L., vice president Northampton National Bank, bds Mansion House
 Washburn Frank I., h 1 Hawley
 Washburn Hattil, carpenter, h 22 Spring

- Washburn M. C. Mrs., h 1 Hawley
 Washington T. Mrs., h South, Florence
 Water Commissioners, office Town Hall
 Waters Albert, farmer, h Smiths Ferry
 Waters Jerry, salesman C R L Co., h 61 South
 Watson Arthur, lawyer 102 Main, bds Prospect ab Massasoit
 Watson Eben L., emp G. Mfg Co., h Maple, Florence
 Watson Henry, h Prospect ab Massasoit
 Watson John, (Watson & Chamberlin), h Loudville
 Watson Joseph L., joiner, h 14 Main, Florence
 Watson Rebecca I. Miss, bds 14 Main, Florence
 Watson & Chamberlin (John Watson, Albert Chamberlin), paper manufacturers, Loudville
 Watts John H., blacksmith, State c Main, res town of Hadley
 Weaver William O., painter, h 6 Summer
 Weaver William O. Mrs, dressmaker, 6 Summer, h do
 Webber James, emp B Bros & Co., h 1 Valley
 Webber John, clerk Donovan & Purcell, bds Florence, Leeds
 Webster William, cutler, h Vernon c Paper Mill road
 Welch Harriet Miss, h 67 South
 Welch John, emp Belding Bros bds 22 Market
 Welch John, gardener, h 78 King
 Welch John W., switchman Conn River R. R., bds 78 King
 Welch Michael, emp Cotton Mill, bds 9 Nonotuck, Florence
 Welch Patrick, moulder F Mach Co., h Spring, Florence
WELCH ROBERT M., eating saloon, Todd's blk, Main, rooms Opera House blk, 120 Main. [See p 282.]
 Welch Thomas, laborer, h Nonotuck, Florence
 Welch William, moulder B. M. Couch, h West, Florence
 Weldon Anne, widow Joseph, h Holyoke, Florence
 Weller Martha Miss, h Park
 Weller Roland, h Park
 Wellington Enos, rem to Holyoke
 Wells Clifton, engineer, bds 23 King
 Wells E. B. Mrs., h 23 King
 Wells Fred W., rem to Springfield
 Wells John L., h 29 South
 Welton Walter B., clerk N L Hospital, h 75 Elm
 Wentworth Henry, machinist, h 3 Clark av
 Wenzel Charles, baker, bds 23 Pleasant
 Wenzel George, coachman, bds 10 Bridge
 West Helen Mrs., emp Mrs. M. K. Olney, bds 145 Main
 Western Union Telegraph Co., Conn R R R depot, and R R Depot, F
 Weston Nathaniel, laborer C. H. Brewster, h South n Main
 Wetherbee Charles W., emp B Bros & Co., h 9 Holyoke
 Wetherbee Helen M. Mrs., (Wetherbee & Pomeroy), h 9 Holyoke
 Wetherbee & Pomeroy, (Mrs. Helen M. Wetherbee, Miss Elvira C. Pomeroy), fancy goods, 50 Main
 Wetherell Samuel E., sawyer, h Bank av n King
 Wetherell see Witherell
 Whalen Ann, widow James, h Water, Florence

- Whalen Bridget, widow John, h off Green n College av
 Whalen Daniel, emp hoe shop, h Hinckley
 Whalen James, mason, h 11 State
 Whalen James, paper maker, emp W & C., h Loudville
 Whalen Mary, widow John, h off Green
 Whalen Mary Mrs., bds South, Florence
 Whalen Mary A. Miss, rem to Springfield, Mass
 Whalen Michael, cutler N Cutlery Co., h N Elm, opp Spring
 Whalen Patrick, laborer, emp 11 Bridge, bds do
 Wheaten Elisha J., clerk 15 Pleasant, bds 7 River
 Wheeler Harriet Mrs., inquire Main n Pine, Florence
 Wheeler Lena Miss, domestic Mrs. S. C. Parsons, Henshaw av
 Wheeler Winslow, yeast peddler, h Masonic
 Wheeler & Wilson Mfg.Co., D. L. Fuller agent, 13 Pleasant
 Whipple Charles L., clerk Hampshire House
WHIPPLE GEORGE R., propr Hampshire House, Main c
 Strong av. See p 277.]
 Whitbeck George S., (George S. Whitbeck & Co., h Union c Pine
WHITBECK GEORGE S. & CO., (George S. Whitbeck, Louis
 B. Graves), pianos and organs, and Opera House ticket agency.
 [See p 247.]
 Whitcomb David B., painter Gothic n Court, h Park n State
WHITCOMB HORACE, livery stable Main c State, h Masonic.
 See p 282.]
 Whitcomb Waldo H., painter, h 11 Park c State
 White August, emp E. N. Foote & Co., h 7 Market
 White Catherine, widow Michael, h 2 Cherry
 White Charles N., emp F Mach Co., h 17 Center, Florence
 White Clarence H., clerk, rem to Easthampton
 White John, laborer, emp 6 Hawley, bds do
 White John, boss grinder C Cutlery, h Main, Bay State
 White John H., emp B Bros & Co., h 52 South
 White Joseph, laborer, h 22 Hawley
 White L. M. Mrs., dress maker 17 Center, Florence, h do
 White Luke B., clerk E. E Hart, bds Main, Bay State
 White Orpha, widow James, h 6 River
 White Sylvester, laborer, h 66 N Maple, Florence
 Whitehouse J. Percy, machinist Knapp Dovetailing Mach Co., h 14
 Franklin
 Whitelock Samuel F., cigar maker, h r Masonic
WHITELOCK THOMAS G., cigar mfr and tobacconist Mansion
 House blk 127 Main, h 24 State. [See p 283.]
 Whitelock Winfield S., cigar maker, bds 24 State
 Whitman Henry M., farmer, h Haydenville road, Leeds
 Whitmarsh Jacob S., carpenter, h 61 N Maple, Florence
 Whitmarsh Sarah Miss, teacher, bds Loudville
 Whitmore Edwin Mrs., h Hospital Hill
 Whitney Alice L., bds 15 Elm
 Whitney Edward compositor Hampshire Herald
 Whittelsey John, cashier Northampton Nat'l Bank, h 52 Elm
 Whitter Ruth Miss, instructor C I D Mutes Round Hill, bds do

- Whittelsey Julia P. Miss, clerk 72 Main, bds 13 South
 Whittelsey M. B., widow John R., h 13 South
 Wilbur Fred T., teamster H. A. Wright, h 13 Holyoke
 Wilbur Fred W., rem to Amherst
 Wilcox Watson L., agt Express Co., agt American Express Co. and U.
 S. & Canada Express Co., freight agt, h 44 N Maple, Florence
 Wilder Henry A., clerk S. Wilder, bds Park
WILDER SAMUEL, stoves, hardware and plumbing, Maple,
 Florence, h Park, do. [See p 264.]
 Willey Adda E., widow Chauncey C., bds 13 Park, Florence
 Wilhelmi Edward M., emp B Bros & Co., h 1 Hancock
 Wilhelmi Ralph L., emp in Springfield, h 1 Hancock
 Willard Francis B., laborer, h Hospital Hill
 Willard Samuel, laborer, h West
 Willcutt Elizabeth S. Miss, clerk 88 Main, h 11 Hawley
 Willcutt George, mason, h 7 Fruit
 Willcutt George W., mason, bds 7 Fruit
 Willcutt Mary E. Miss, clerk Lincoln & Bell, bds 7 Fruit
 Willcutt Mary J. Miss, h 11 Hawley
 Willcutt Sarah S., widow Daniel, h 2 Maple
 Willey George A., physician Pine c Maple, Florence, h do
 Williams Charles, liveryman, King, h 46 Market
 Williams Charles A., h Market
 Williams Charles E., rooms 17 South
 Williams Elisha, book keeper Northampton Beef Co., h 87 Elm
 Williams Emeline, widow Michael, h 2 Bridge
 Williams Eugene, driver, emp M. W. Jackson, bds North
 Williams Eliphalet P., h 70 King
 Williams Fannie Miss, h King
 Williams Henry F., treas Williams Mfg Co., h 21 Pomeroy Terrace
 Williams Henry L., bds South opp School
 Williams Joseph C., bds 2 Bridge c Market
 Williams Lucien B., prest Williams Mfg Co., h South opp School
WILLIAMS MAN'F'G CO., basket manufacturers, foot Smith.
 [See p 233.]
 Williams Nathan, emp E. N. Foote & Co., bds 32 Market
 Williams Sarah D., widow Harlow, bds Prospect n Park
 Williams Willis, emp Mansion House, bds do
 Willis Albert H., (A. H. Stocker & Co.), res Palmer
 Williston A. Lyman, treasurer and agent Greenville Mfg Co., h Round
 Hill
 Williston C. L. widow J. P., h 7 King
 Williston John M., tinner, emp W. F. Prindle, h Prospect c Summer
 Wilmot John, blacksmith, h West, Florence
 Wilson Agnes S., widow James, h Hospital Hill
 Wilson Charles H., rem to Holyoke
 Wilson Harry, rem to Newark, N J
 Wilson Henry M., farmer N L Hospital, h West n iron bridge
 Wilson James, farmer, h Pine Grove
 Wilson Joseph, farmer, h Pine Grove
 Wilson Lizzie A. Miss, domestic 32 Elm

- Wilson Mary Miss, Hospital Hill
 Winchell Nathaniel P., book keeper F Mfg Co., bds 5 Main, Florence
 Wing Charles N., rem to Deerfield
 Wing Sing, laundry 138 Main, h do
 Winslow Alice Miss, artist emp Hardie & Schadee, bds 2 Maple
 Winter E. Mrs., rem to Haydenville
 Witherell Alphonso, grocer, h 22 Olive
 Witherell Charles, emp B Bros & Co., bds 8 Hawley
 Witherell Charles R., carpenter F Mach Co., h Oak, Florence
 Witherell Edward, emp Clement Mfg Co., bds Main, Bay State
 Witherell Elisha L., joiner, h Chestnut ab High, Florence
 Witherell Harriet, widow James, h 55 Gothic
 Witherell John, emp B. M. Couch, bds Oak, Florence
 Witherell Phoebe Mrs., bds 20 Olive
 Witherell William, carpenter F Mach Co., h 72 N Maple, Florence
 Witherell William J., clerk, bds 55 Gothic
 Wolfskiel William, emp O. R. Maynard, bds do
 Wood Andrew S. Mrs., h Elm c Massasoit
 Wood Eben T., veterinary surgeon, Strong av opp C R R depot, h River
WOOD EBEN T. JR., livery stable Strong av, opp C R R depot,
 h Pearl. [See p 280.]
 Wood Edward E., supt and treas N Cutlery Co., h 89 Elm
 Wood Edward E. Jr., shipping clerk N Cutlery Co., bds 89 Elm
 Wood George W., emp Dr. Roberts, h Center av
 Wood James T., emp Eames & Sprague, bds River
 Wood Lewis H., rem to Hartford
 Wood Susan Mrs., h 26 Market
 Woodruff Jerusha A., widow William C., h 21 West
 Woodruff John, engineer N Cutlery Co., h Main, Bay State
 Woodruff William G., sewing machine canvasser, bds Nonotuck House
 Woodward Frank W., clerk E. A. Brooks, bds 10 River
 Woodward John E., teamster, h 19 Cherry
 Woodward Marcus M., emp N Cutlery Co., h 31 Vernon
 Woodward Orion L., h Maple c Center, Florence
 Woodworth James E., sewing machine agent, bds Nonotuck House
 Worcester Alice E. Miss, special teacher of articulation C I D Mutes,
 Round Hill, bds do
 Worcester Catherine E. Miss, teacher Latin 17 Elm, bds do
 Worsley William, emp B Bros & Co., h Williams
 Works Lillian M. Miss, attendant N L Hospital
 Worth Nannie M. Miss, dress maker, bds 26 N Main, Florence
 Worth Sarah, widow Charles P., h 26 N Main, Florence
 Worthen Charles H., pattern maker, h 22 Main
 Worthen Edwin J., rem to Worthington
 Worthen George, emp N. Cutlery Co., bds 22 Main
 Wotton Samuel W., truckman, h 8 West blk, River
 Wright Anna Miss, bds 14 Bridge
WRIGHT ANSEL, deputy sheriff and manager Norwood Ice Co.
 120 Main, h 19 Maple
 Wright Burr, bds 6 River
 Wright Charles A., machinist, bds Lincoln av

Wright Charles E., emp E. A. Brooks, bds 6 North
 Wright Charles M., farmer, bds 42 South
WRIGHT DAVID J., agricultural tools and grocer, Union blk,
 36 Main, h 19 West. [See p 255.]
 Wright F. Hunt, h 14 Bridge
 Wright Fred, book keeper Ansel Wright, bds 19 Maple
 Wright Fred E., traveling salesman, bds River
 Wright George L., farmer, h 41 South
 Wright Georgiana Mrs., h Crafts av
 Wright Harriet M., widow Asa, h 19 West
WRIGHT HENRY A., wood dealer, (Mt. Tom), bds 41 South.
 [See p 266.]
WRIGHT HENRY A., lumber dealer opp N H & N freight de-
 pot, h 29 Pleasant. [See p 267.]
 Wright Hervey J., emp Crystal Emery Wheel Co., h Lincoln av
 Wright Isaac L., farmer, h 13 High
 Wright James G., farmer, h 24 Bridge
 Wright Luther C., farmer, bds 2 Fruit
 Wright Martin H., farmer, bds 13 High
 Wright Ozro C., farmer, h 2 Fruit
 Wright Silas A., janitor high school, h River
 Wright Silas M., farmer, h 2 Fruit
 Wright Seth B., bds Mansion House
 Wright Willian K., piano tuner, h Prospect
 Wisley Edgar J., emp Clapp Bros., h 60 South c Fort
 Wuensch Emil, emp M R B Co., h Warner's row, Leeds
 Wyman J. A. R., carpenter, h Smiths Ferry

YALE CAROLINE A. MISS, assist principal C I D Mutes, Round Hill,
 bds do
 Yale Harriet O., Miss matron C I D Mutes, Round Hill, bds do
 Yeateman Fred, carpenter, h Leonard, Leeds
 Yost Charles E., tack maker, h Holyoke n Main, Florence
 Yost Emma L., emp N Silk Co., bds Holyoke, Florence
 Yost Susan, widow John, h Holyoke, Florence
 Young Antony, emp N Silk Co., h Water, Leeds
 Young Francis, emp W Mfg Co, h 22 Pleasant
 Young Henry Mrs., h Hawley, opp silk mill
 Young John Mrs., h North
 Young Joseph, emp W Mfg Co., h Kirkland av
 Young Joseph, carpenter, h Holyoke c Williams
 Young Joseph H., emp B Bros & Co., h 21 Hawley
 Young Joseph S., emp N Silk Co., h Meadow c Lilly
 Young William H., engraver E. N. Foote & Co., h 19 Summer

ZIEHLKE CHARLES, h Hinckley, Bay State
 Zinsser Henry, barber Maynard & Kimball, bds 37 Center

Northampton Business Directory.

Acids.

KING ALBERT, office Myrtle, Florence. (See p 241.)

Agricultural Implements.

Branch R. M., Main, Florence

Springer John, 30 Main

SULLIVAN J. A., opp Canal R R Depot. (See outside back cover.)

WRIGHT D. J., Union Block, 36 Main. (See p 255.)

Agricultural Tool Manufacturer.

MAYNARD C. A., foot Green. (See inside back cover.)

Apothecaries.

BARNES F. A. & W. E., 20 Main, Florence. (See p 256.)

CLARK & PARSONS, 125 Main. (See inside front cover.)

Davis N. A., Main, Florence

EDWARDS O. & CO., 100 Main. (See p 256.)

Kingsley C. B., 106 Main

WALKER GEORGE H. & CO., 90 Main. (See p 256.)

Architects.

PRATT W. F. & SON, 105 Main. (See p 268.)

Art Rooms.

LINCOLN & BELL, 70 Main. (See p 248.)

Artists.

CLARK EDSON P., 56 Bridge. (See p 246.)

HOTCHKISS WALES, Union Block, 38 Main. (See p. 246.)

Asphalt Paver.

SIMPSON J. B., office Mansion House, home office, Newton, Mass.
(See p 281.)

Attorneys at Law.

Bassett William G., 74 Main
Bond Daniel W., Jones' blk, Court
Bottum John B., 66 Main
Clapp William H., County Court House, Main
CLARK CHARLES N., over Northampton Nat'l Bank, 101 Main.
(See p 243.)
Chilson H. H., over First National Bank, Main
Delano Charles G., 113 Main
Field Henry P., with J. C. Hammond, over First Nat'l Bank, Main
Field George D., Jones' blk, Court
HAMMOND JOHN C., over First Nat'l Bank, Main. (See p 242.)
HILL & WAINWRIGHT, over N. I. for Savings. (See p 243.)
O'DONNELL JOHN B., Opera House blk, 120 Main. (See p 243.)
PARSONS & CROSSLEY, Kirkland's blk. 52 Main. (See p 242.)
SPAULDING T. G., over N. I. for Savings, Main. (See p 242.)
Stone Isaac, 112 Main
Strickland William P., 46 Main
Watson Arthur, 102 Main

Auctioneers.

Longley H. A., Union
PARSONS ENOS, 52 Main. (See p 242.)
Potter Henry M., Opera House blk, 120 Main.

Bakers.

Carr Smith, Carr's blk, 153 Main
COUTURE E., 10 Market. (See p 262.)
LYMAN & SHIPMAN, 153 Main. (See p 258.)
MADISON JOHN W., Main c Maple, Florence. (See p 258.)
Olney M. K. Mrs., 143 and 145 Main

Bands.

Belding Bros. Brass Band
Florence Military Brass Band, A. W. Chase, leader, Florence
Leeds Brass Band, Andrew Sydell, leader, Leeds
Opera House Orchestra, 124 Main

Banks.

FIRST NATIONAL BANK OF NORTHAMPTON, Wm. L.
Pres. H. F. Williams, V Pres. Frederick N. Kneeland
ier. Capital \$500,000. Cor Main and King. (See p 25)

Cheney Bigelow Wire Works,

MANUFACTURERS OF

Improved Wove and Laid Dandy Rolls.



Fourdrinier Wires of Best Quality.

OFFICE AND FACTORY,
TAYLOR STREET,
SPRINGFIELD, MASS.

ESTABLISHED 1842.

Cheney Bigelow Wire Works.

Manufacturers
of
all kinds of



FOR
Manufacturing
and other
Purposes.

Wire Guards and Wire Railing

FOR OFFICES, BANKS AND PUBLIC BUILDINGS.

*Improved Door and Window Screens,
COAL and SAND SCREENS.*

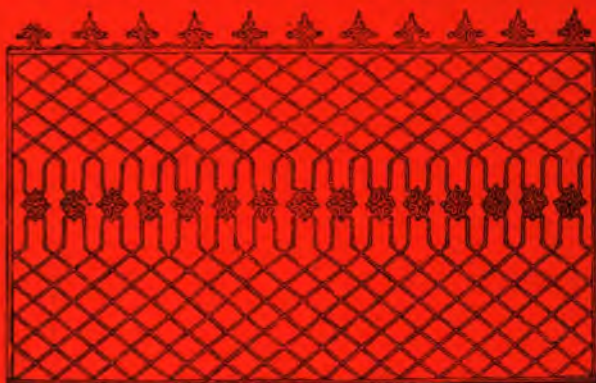

*FOUNDRY RIDDLERS,
CASTING BRUSHES.*



**SIEVES,
GALVANIZED WIRE NETTING**
For Poultry Yards.

Trellises, &c.

Wire Work.



CORRESPONDENCE SOLICITED.

Office and Factory, Taylor Street,

— — — SPRINGFIELD, MASS.

HAMPSHIRE COUNTY NATIONAL BANK, Luther Bodman, Pres. Lewis Warner, Cashier. Capital \$250,000. 112 Main, n South. (See p 229.)

NORTHAMPTON NATIONAL BANK, Oscar Edwards, Pres. J. L. Warriner, Vice Pres. J. Whittelsey, Cash'r. Capital, \$400,000. 99 Main c Center. (See p 227.)

Banks—Savings.

FLORENCE SAVINGS BANK, A. T. Lilly, Pres. M. W. Bond, Secretary and Treasurer. Davis' blk, Main, Florence. (See p 226.)

HAMPSHIRE SAVINGS BANK, Luther Bodman, Pres. Lewis Warner, Treasurer. Established 1869. 112 Main. (See p 226.)

NORTHAMPTON INSTITUTION FOR SAVINGS, H. G. Knight, Pres. L. Maltby, Treasurer. T. G. Spaulding, Secretary. Main. (See p 225.)

Barber Shops.

Dragon Louis, 111 Main

Fanion Octavia, 197 Main

Forand Albert, basement Mansion House, Main

Furth Rudolphus, 29 Maple, Florence

Maynard & Kimball, 3 Pleasant

Murphy Patrick, Florence Hotel, Maple, Florence

Smith Thomas, 78 Main

Wallace Edward F., 181 Main

Basket Manufactory.

WILLIAMS MFG CO., L. B. Williams, Pres. H. F. Williams, Treas., foot Smith. (See p 233.)

Bath Rooms.

Wallace Edward F., 181 Main

Beef—wholesale.

Northampton Beef Co., Market n Main

Bill Poster.

Coakley James, Opera House

Billiard Halls.

W'N RODNEY, Mansion House, Main. (See p 277.)

nce House, M. Cooney, Main c Maple, Florence

WELL JAMES, 11 Pleasant. (See p 284.)

Blacksmiths and Horseshoers.

Bachus Gurdin, Nonotuck, Florence
 Bryant Allen, Maple n R R crossing, Florence
 Clark Levi I., Center
 DAVIS R. B. & CO. (blacksmiths), 11 South. (See p 275)
 Deane Thomas, junc Nonotuck and Main, Florence
 Francis Vetile, Main nearly opp Edwards Church
 Hartwell W. S., r 27 Maple, Florence
 HERRICK W. (machine), Pleasant. (See p 239.)
 Laframboise & Dragon, r 7 Masonic
 RICE B. F., 19 Fruit c Smith. (See p 276.)
 RICHARDSON C. L., Court r Smith's blk. (See p 276.)
 Rowe John, Main n Nonotuck, Leeds
 Stevens W. H., Loudville
 Watts John, State c Main

Blank Book Manufacturer.

CHILDS HENRY, 74 Main. (See inside back cover.)

Boarding Houses.

Eldredge Geo. L. (Belding Bros & Co.), Williams
 GERMANIA SINGING SOCIETY CLUB HOUSE, John Bern-
 hardt, manager, Court c King. (See p 284.)
 Griffin James C., 33 Pleasant
 Horton E., Mt Tom
 Houston Samuel R., 30 Maple, Florence
 Maynard H. E., Center
 Nichols W. M., Bay State
 Smith E. S. Mrs., 10 River
 Sydell A. G., Water, Leeds

Book Binders.

CHILDS HENRY, 74 Main. (See inside back cover.)
 Cornwell E. J., Union blk, 34 Main

Books and Stationery.

Bird J. W., Main c Maple, Florence
 BRIDGMAN S. E. & CO., 76 Main. (See opp inside back cover.)
 CARLEY A. G., 115 Main. (See p 255.)
 MARSH JOSEPH, 48 Main. (See p 255.)

Boot and Shoe Dealers.

Baker H. H., 60 Main
 Branch R. M., Main, Florence
 Cohn S., 44 Main

Cutler, Plimpton & Co., Maple c W Center, Florence
 DONOVAN & PURCELL, Main, Leeds. (See p 261.)
 HADLEY S. D. & CO., 98 Main. (See p 257.)
 Hart E. E., Main, Bay State
 HOSMER PHINEAS P., 189 Main. (See p 257.)
 KNOWLTON JOSHUA, Todd's blk, 119 Main. (See p 257.)
 NADEAU F., Bridge c Water, Leeds. (See p 261.)
 O'Donnell & Herlihy, Water, Florence
 Pease R. H., Maple, Florence
 PHELPS J. C., 54 Main. (See p 254.)
 ROSS E. S., Nonotuck, Leeds. (See p 261.)
 SHERWIN A., 18 Main. (See front cover.)

Boot and Shoe Makers and Repairers.

Anderson James, Davis' blk, Main, Florence
 Brown Lyman, Main, Bay State
 Coigan Thomas, Nonotuck n Silk Mill, Florence
 DONOVAN & PURCELL, Main, Leeds. (See p 261.)
 Frary Dexter, 54 Main
 Giebenheim G., 16 Main, Florence
 Hanley John, 5 Pleasant
 Hebert A., 140 Main
 HOSMER PHINEAS P., 189 Main. (See p 257.)
 Humphrey Carlos, 45 Main, Florence
 KNOWLTON JOSHUA, Todd's blk, 119 Main. (See p 257.)
 Menard F. X., basement Mansion House, Main
 Tacy J., Water, Leeds
 Torrey C., Main, Leeds

Bottlers.

Boynton W. W., River
 DÉWEY P. H., 141 Main. (See p 283.)
 McCANDLESS WM., Masonic n Main. (See p 283.)
 Parnell John, 6 Pleasant

Box Makers.

Goodwin Walter C., 48 N Maple, Florence
 KINGSBURY A. & SON, (paper,) Union blk, 38 Main. (See p 240.)
 Rust Stephen A., Loudville
 Smith Levi W., (lock corner packing), Pleasant

Brick Manufacturers.

Day N. & Bros., South opp Hospital Hill
 Nutting Porter, Elm, foot of hill towards Florence

Brokers.

ARNOLD J. W. (paper), 90 Main. (See p 232.)
 Crafts Josephus, 29 Market
 Dawson L. A., Round Hill
 Edwards Henry L. (loan), 108 Main
 PARSONS ENOS, Kirkland's blk, 52 Main. (See p 242.)
 Turner J. M., Hamp Co. Nat'l Bank bldg, 112 Main
 WALKER OLIVER, 52 Main. (See p 245)

Broom Manufacturers.

Smith H. E., Strong av, n C R R, depot
 Smith Rodolphus, Washington av

Broom Handle Dealers.

Graves Robert B., 93 Bridge
 Smith Charles O., Union

Brush Manufactory.

FLORENCE MFG. CO., junc Nonotuck and Pine, F. (See p 236.)

Building Movers.

FIELD ZENAS, house lower end Pleasant. (See p 275.)
 MURRAY JOSEPH, house King. (See p 274.)

Butchers.

Clapp & Johnson, 109 Main
 JACKSON M. W., 126 Main. (See p 262.)

Button Manufactories.

Ayres A. W., 28 Main
 Clapp Charles E. & Co., Pleasant c Holyoke
 FOOTE E. N & CO., Masonic c Masonic av. (See p 236.)
 Mill River Button Co., Geo. P. Warner, treas., Leeds
 TIGERITE MFG CO. (jobbers), 34 Main. (See p 238.)

Cabinet Makers.

FISH F. W., Court r Jones' blk. (See p 263.)
 Orcutt T. A., Maple, Florence

Candle Manufacturer.

Sawyer Amos, Locust

Carpenters and Builders.

Bartlett Oliver, West Farms
 Brown William E., 16 Market
 Clapp & Brewer, N Maple, Florence
 Connelley Stephen, Gothic n Court
 CROUCH C. S., 26 Pleasant. (See p 270.)
 Dietrich Peter, N Elm
 Edwards L. H., Union
 GEROU HENRY, Water, Leeds. (See p 269.)
 Goodwin Walter C., 48 N Maple, Florence
 HARLOW CHARLES N. & CO., Kirkland av. (See p 268.)
 HEBERT B. & SON, Bridge opp the cemetery. (See p 270.)
 HEBERT JOSEPH, Gothic n Court. (See p 268.)
 HUXLEY JOHN, 5 Arlington. (See p 269.)
 Marcotte Frank, High, Leeds
 Orcutt T. A., Maple, Florence
 Pratt Charles S., 11 North
 Smith C. Butler, 17 N Main, Florence
 SMITH & LIVERMORE, Center. (See p 270.)
 Warner William J., Main, Florence

Carpet Dealers.

Cutler, Plimpton & Co., Maple c W Center, Florence
 FEARING & EVERETT, 86 Main. (See p 249.)
 LINCOLN & BELL, 70 Main. (See p 248.)
 ROSS E. S., Nonotuck, Leeds. (See p 261.)
 Currier E. B. (oil cloths only), 15 Pleasant.

Carpet Washing.

CRYSTAL EMERY WHEEL CO., Hawley N Main. (See p 235.)

Carriage and Wagon Makers.

DAVIS R. B. & CO., 11 South. (See p 275.)
 JAGER JOHN C., Maple, Florence. (See p 276.)
 Orcutt T. A., Maple, Florence
 PHELPS G. S., 7 Masonic. (See p 275.)
 ROSEBUSH GILBERT, Main opp Masonic. (See p 276.)

Carriage Painters.

Clark I. R., 3 Court c King
 DAVIS R. B. & CO., 11 South. (See p 275.)
 Hazen James O., 7 Masonic
 Hamilton L. W., Court c King
 JAGER JOHN C., Maple, Florence. (See p 276.)

Carriage Repositories.

JAGER JOHN C., Maple, Florence. (See p 276.)

LOOMIS G. L. & Co., 8 Pleasant. (See p 259.)

Carriage Trimmers.

DAVIS R. B. & CO., 11 South. (See p 275.)

ROSE S. C., 7 Masonic. (See p 275.)

Chair Seating and Repairing.

Ware S. M., 3 Pleasant

Chemists.

CLARK & PARSONS, Mansion House Block, 125 Main. (See inside front cover.)

WALKER GEORGE H. & CO., 90 Main. (See p 256.)

Chiropodist.

Morton L. P., 5 Union Block, 38 Main.

Cigar Manufactories.

GABB CHARLES N., Todd's block, 121 Main. (See p 283.)

Slattery T. J., 179 Main

WHITELOCK THOMAS G., 127 Main, Mansion House block. (See p 283.)

Cigar Stores.

Dewey John T., 159 Main

GABB CHARLES N., Todd's block, 121 Main. (See p 283.)

McCANDLESS WILLIAM, Masonic n Main. (See p 283.)

RUDER BRUNO, 4 King. (See p 284.)

Slattery T. J., 179 Main

WHITELOCK THOMAS G., 127 Main, Mansion House block. (See p 283.)

Civil Engineer and Surveyor.

Davis E. C., McCallum's block, 114 Main

Clothiers.

Clark Merritt & Co., 110 Main

Cohn S., 44 Main

FRENCH M. M. & CO., 82 Main. (See p 253.)

Jacobson L. E. & Co., 118 Main
 PARSONS H. K., Maple c Main, Florence. (See p 253.)
 SHERWIN A., 18 Main. (See outside front cover.)
 SMITH & PRINDLE, 68 Main. (See p 252.)
 Sobotky P., 6 Main
 Tisch A., 42 Main

Coal and Wood.

CLAPP WILLIAM D., Strong av n C R R depot. (See p 265.)
 Goodwin E. B. & W. C., 48 N Maple, Florence
 KIMBALL & CARY, Main c Hawley. (See p 265.)
 MAYNARD C. A., 130 and 132 Main. (See inside back cover.)
 Orcutt T. A. (wood), Maple, Florence
 PARSONS H. K., Maple c Main, Florence. (See p 253.)
 Pease R. H., Maple, Florence
 Union Coal Yard, L. A. Clark, proprietor, 39 Pleasant
 WRIGHT H. A. (wood), Mt Tom, res 4i South. (See p 266.)

Coffin and Casket Manufacturers.

Florence Furniture Company, Myrtle, Florence

Concrete Paver.

SIMPSON J. B., office, Mansion House, home office, Newton, Mass.
 (See p 281.)

Confectioners.

(See Fruit and Confectionery.)

Confectionery Manufacturers.

LYMAN & SHIPMAN, 153 Main. (See p 258.)

Cotton Goods Manufacturers.

DAMON NARROW FABRIC COMPANY (tape), Pleasant c Strong
 av. (See p 237.)
 GREENVILLE MANUFACTURING COMPANY, junc Nonotuck
 and River, Florence. (See p 240.)

Cracker Manufacturer.

Carr Smith, Carr's blk, 153 Main

Crockery, Glass and Earthen Ware.

Branch R. M., Main, Florence
 Cutler, Plimpton & Co., Maple, Florence
 DEARDEN WILLIAM, 32 Main. (See p 250.)
 DONOVAN & PURCELL, Main, Leeds. (See p 261.)
 Hart E. E., Main, Bay State
 NADEAU FELIX, Bridge, Leeds. (See p 261.)
 O'Donnell & Herlihy, Water, Florence
 ROSS E S., Nonotuck, Leeds. (See p 261.)
 RUST T. & SONS, Rust blk, 163 Main. (See p 260.)
 Sanderson & Delano, 173 Main
 SACKETT R. W. & J. R., 2, 4 and 6 King. (See p 253.)
 Currier E. B., 15 Pleasant

Cutlery Manufactories.

Clement Manufacturing Company, Bay State.
 NORTHAMPTON CUTLERY COMPANY, Main, Bay State.
 (See p 235.)

Dentists.

BROWN R. D., Davis' blk, Main, Florence. (See p 244.)
 CRITTENDEN G. W., McCallum's blk, 114 Main. (See p 244.)
 Davenport J. N., 62 Main
 JONES W. H., Clarke blk, 58 Main. (See p 244.)
 Meekins Thomas W., 108 Main
 Rust Lewis, 17 Maple
 STONE J. Q., room 3, Union blk, 38 Main. (See p 244.)

Deputy Sheriffs.

(See County Officers.)

Dining Rooms.

Dakin & Lee, N H & N R R Depot
 Edwards H. O., 135 Main
 Hart L. R., 203 Main
 Olney M. K. Mrs., 143 and 145 Main
 Pittsinger J. W., 20 Main
 WELCH R. M., Todd's blk, Main. (See p 282.)

Doors, Sash and Blinds.

Clark I. R., 3 Court c King
 TYLER JOHN, 134 Main. (See p 278.)

Dovetail Machine Manufacturer.

Knapp Dovetailing Machine Co., Florence

Drain and Sewer Pipe.

PRINDLE W. F., 149 Main. (See p 263.)

Dress and Cloak Making.

Barrett Etta G. Miss, 12 South
 Brackett A. M. Mrs., 8 Center, Florence
 Childs M. D. Mrs., 58 Main
 Clark Helen Miss, 8 Maple
 Dickinson Mary E. Mrs., Cook's marble blk, 74 Main
 Eggleston Hannah Mrs., Lilly, Florence
 Fiske F. Miss, 5 Market
 Harrington C. H. Mrs., 11 Main, Leeds
 Hays M. A. Miss 22 Main
 Knapp Lida C. Miss, 8 Main
 Knight E. P. Mrs., Henshaw av
 Loud Lucy, 33 South
 O'Grady Mary A., Nonotuck, Florence
 Rodimon W. S. Mrs., Mansion House
 Rowland J., 7 Fruit
 Smith Sophia C., 169 Main
 Tunnicliffe Wm. Mrs., Myrtle c State
 Twiss M. E. Mrs., 62 Main
 Weaver William Mrs., 6 Summer
 White L. M. Mrs., 17 Center, Florence

Dress Scale.

Crouch C. S. Mrs., 26 Pleasant

Drugs and Medicines.

(See also Apothecaries.)

BARNES F. A. & W. E., 20 Main, Florence. (See p 256.)
 CLARK & PARSONS, 125 Main. (See inside front cover.)
 EDWARDS O. & CO., 100 Main. (See p 256.)
 WALKER GEORGE H. & CO., 90 Main. (See p 256.)

Dry Goods.

Branch R. M., Main, Florence
 Clapp E. I., 10 Main
 Cutler, Plimpton & Co., Maple, Florence
 Daley P. J., Water, Florence
 FEARING & EVERETT, 86 Main. (See p 249.)
 Hart E. E., Main, Bay State
 LAMBIE J. E. & CO., 64 Main. (See p 249.)

LINCOLN & BELL 71 Main. (See p 248.)
 McCALLUM A. 116 Main. (See p 248.)
 NADEAU FELIX, Bridge & Water, Leeds. (See p 241.)
 Key John E., Davol St., Main, Florence
 ROSS E. S., Nonotuck, Leeds. (See p 241.)

Dyeing.

HAMPSHIRE STEAM DYE HOUSE, F. W. Kiser, 7 State. (See p 275.)

Eating Houses.

(See Restaurants.)

Emery Wheel Machinery Manufacturers.

CRYSTAL EMERY WHEEL COMPANY, Hawley n Main. (See p 235.)
 NORTHAMPTON EMERY WHEEL COMPANY, Nonotuck, Leeds (See p 234.)

Emery Wheel Manufacturers.

CRYSTAL EMERY WHEEL COMPANY, Hawley n Main. (See p 235.)
 NORTHAMPTON EMERY WHEEL COMPANY, Nonotuck, Leeds (See p 234.)

Expressmen and Teamsters.

Abercrombie Joel, house 7 Main, Florence
 Bradford Ansel, house Main, Florence
 BUCKNAM H. S., 124 Main. (See p 274.)
 Chapman H. S. (Northampton, Florence, Leeds, Haydenville and Williamsburg), 100 Main
 Curran Michael J., Leonard, Leeds
 Cushing A. M., 6 Maple
 DICKINSON GEO. F., 90 and 125 Main. (See p 274.)
 HOWES E. B., Maple, Florence. (See p 273.)
 Kellogg Charles, Maple
 LANDY BROS & CO. (heavy trucking) Nonotuck, F. (See p 272.)
 Moore L. B., office I. A. Graves, Maple, Florence
 MURRAY JOSEPH, King. (See p 274.)
 PARSONS S. L. & SON (heavy trucking), 12 West. (See p 273.)
 Pretty Adam, house King c Edwards
 Randall H. M., house 7 River
 Robbins L. T., Florence, Leeds
 SALOIS JOSEPH, r 35 Pleasant. (See p 273.)
 Sunderson C. B. (Northampton, Hadley and South Hadley), 26 Main
 Strong W. H., house Grant av
 Wotton S. W., 8 River

Express Offices.

American Express Company, H. W. Dewey, agent, 26 Main ; W. L. Wilcox, agent, N H & N R R depot, Florence ; S. L. Bolter, agent, office at depot, Leeds
 United States and Canada Express, H. W. Dewey, agent, 26 Main ; W. L. Wilcox, agent, N H & N R R depot, Florence ; S. L. Bolter, Leeds

Fancy Goods.

Brackett A. Mrs. ; 8 Center, Florence
 Clapp E. I., 10 Main
 COPELAND E. P., 72 Main. (See p 252.)
 DICKINSON CHARLES H., 88 Main. (See p 251.)
 Ensign Henry N., 94 Main
 FEARING & EVERETT, 86 Main. (See p 249.)
 LAMBIE J. E. & CO., 64 Main. (See p 249.)
 LINCOLN & BELL, 70 Main. (See p 248.)
 Mann E. A. Mrs., 10 Maple, Florence
 McCALLUM A., 116 Main. (See p 248.)
 TIGERITE MFG. CO. (jobbers), 34 Main. (See p 238.)
 Wetherbee & Pomeroy, 50 Main

Fertilizers.

Brown Charles T., Main c Hawley
 Clapp E. C. & Bro., South
 Horton D. A., R R Steam Mill, Main
 Phelps H. L., Strong av n C R R R depot
 SULLIVAN J. A., Main opp Canal R R depot. (See outside back cover)
 WRIGHT D. J., Union blk, 36 Main. (See p 255.)

Fire Brick.

GRAVES M. L. & M. W., R R Steam Mills, Main c Market. (See p 258.)
 SULLIVAN J. A., Main opp Canal R R depot. (See back cover.)

Fish Markets.

Hyde C. L., 20 Main, Florence
 Law Wm., Center, Florence
 LOOMIS G. L. & CO., 8 Pleasant. (See p 259.)
 Shea Thomas, 195 Main

Florists.

Brainard E. A., Elm c Vernon
 Brewster Charles H., South n Main

Flour and Feed.

Branch R. M., Main, Florence
 Clapp W. W., 5 Union
 GRAVES M. L. & M. W., R R Steam Mills, Main. (See p 258.)
 Hager Isaac N., Main c Hawley
 Hart E. E., Main, Bay State
 MAYNARD C. A., 130 and 132 Main. (See inside back cover.)
 NADEAU F., Bridge c Water, Leeds. (See p 261.)
 PARSONS H. K., Maple c Main, Florence. (See p 253.)
 Pease R. H., Maple, Florence
 ROSS E. S., Nonotuck, Leeds. (See p 261.)
 SULLIVAN J. A., Main opp N H & N depot. (See outside back
 • cover.)

Fruit at Wholesale.

LOOMIS G. L. & CO., 8 Pleasant. (See p 259.)

Fruit and Confectionery.

Hart L. R. 203 Main
 Hyde C. L., 20 Main Florence
 LEWIS R. & SON, 193 Main. (See p 261.)
 LYMAN & SHIPMAN, 153 Main. (See p 258.)
 MADISON J. W., Main c Maple, Florence. (See p 258.)
 Olney M. K. Mrs., 143 & 145 Main
 Pittsinger J. W., 20 Main

Fruit Evaporator Manufacturers.

Valley Fruit Evaporator Company, R. R. Steam Mill, Main c Market

Furniture Dealers.

SACKETT R. W., & J. R., 2, 4, and 6 King. (See p 253.)
 Sanderson & Delano, 173 Main
 SEARLE & EDWARDS, Center r First Church. (See back cover.)
 SMITH W. L. & CO., 8, 9, 10, and 11 Court. (See inside front
 cover.)

Furniture Repairers.

FISH F. W., r Jones block, Court. (See p 263.)
 Morton L. P., 38 Main

Furs.

STOCKER A. H. & CO., 96 Main. (See p 251.)

Gas Fitters.

(See Steam and Gas Fitters.)

Gas Light Company.

Northampton Gas Light Company, M. M. French, Pres. ; W. B. Hale,
Treas. ; D. W. Crafts, Supt. Office, Granite Row, 105 Main

Gents' Furnishing Goods.

Cohn S., 44 Main
Clark Merritt & Co., 110 Main
Cutler, Plimpton & Co., Maple, Florence
FRENCH M. M. & CO., 82 Main. (See p 253.)
Jacobson L. E. & Co., 118 Main
O'Donnell & Herlihy, Water, Florence
PARSONS H. K., Maple c Main, Florence. (See p 253.)
Riley John E., Davis block, Main, Florence
SHERWIN A., 18 Main. (See outside front cover.)
SMITH & PRINDLE, 68 Main. (See p 252.)
STOCKER A. H. & CO., 96 Main. (See p 251.)

Grading.

PARSONS S. L. & SON, 12 West. (See p 273.)

Granite Workers.

KINNEY C. W. Court c King. (See p 272.)
Rushford Lewis M., Pleasant, rear C. E. Clapp's foundry

Grain and Grist Mills.

GRAVES M. L. & M. W., R. R. Steam Mills, Main. (See p 258).
Strong Francis, Loudville

Groceries and Provisions.

Bernhardt John, 2 King
Branch R. M., Main, Florence
BROOKS, E. A., 14 Main. (See p 260.)
Carroll Matthew, 1 Masonic
CLARK & PARSONS, 125 Main. (See inside front cover.)
COUTURE E., 10 Market. (See p 262.)
Cutler, Plimpton & Co., Maple, Florence
DONOVAN & PURCELL, Main, Leeds. (See p 261.)
EDWARDS O. & CO., 100 Main. (See p 256.)
EDWARDS BROS., Mansion House block, 133 Main. (See p 260.)
Hart E. E., Main, Bay State
Hyde C. L., 20 Main, Florence

Kingsley Charles B., 106 Main
 Laurion & Landry, Masonic
 LEWIS R. & SON, 193 Main. (See p 261.)
 LOOMIS G. L. & CO., 8 Pleasant. (See p 259.)
 NADEAU F., Bridge c Water, Leeds. (See p 261.)
 O'Donnell & Herlihy, Water, Florence
 Pease R. H., Maple, Florence
 ROSS E. S., Nonotuck, Leeds. (See p 261.)
 RUST T. & SONS, Rust's block, 163 Main. (See p 260.)
 Shea Thomas, 195 Main
 TOWNE J. M. & SONS, 201 Main. (See p 259.)
 WALKER G. H. & CO, 90 Main. (See p 256.)
 Watson & Chamberlin, Loudville
 WRIGHT D. J., Union block, 36 Main. (See p 255.)

Hardware and Cutlery.

Currier E. B., 15 Pleasant
 Springer John, 30 Main
 WILDER SAMUEL, Maple, Florence. (See p 264.)

Harness Makers and Dealers.

Abercrombie E. L., Main c Maple, Florence
 Hayes & Burby, 193 Main
 Smith H. P., 165 Main

Hair Dressers.

(See barbers.)

Hats and Caps.

Branch R. M., Main, Florence
 Cutler, Plimpton & Co., Maple, Florence
 FRENCH M. M. & CO., 82 Main. (See p 253.)
 Jacobson L. E. & Co., 118 Main
 O'Donnell & Herlihy, Water, Florence
 PARSONS H. K., Maple c Main, Florence. (See p 253.)
 Riley John E., Main, Florence
 ROSS E. S., Nonotuck, Leeds. (See p 261.)
 SHERWIN A., 18 Main. (See outside front cover.)
 Sobotky P., 6 Main
 STOCKER A. H. & CO., 96 Main. (See p 251.)

Hat Bleaching.

Ayres A. W., 28 Main.

Hay and Straw.

GRAVES M. L. & M. W., Railroad Steam Mills, Main. (See p 258.)
 Pease R. H., Maple, Florence
 SULLIVAN J. A., opp NH & N R R depot. (See outside back cover.)

Hides and Tallow.

Clapp & Johnson 109 Main
 JACKSON MERRILL W., 126 Main. (See p 262.)
 RAFTRY THOMAS, 9 Pleasant. (See p 262.)

Hoe, Shovel and Trowel Manufacturer.

MAYNARD C. A., foot Green. (See inside back cover.)

Homeopathic Pharmacy.

WALKER GEORGE H. & CO., 90 Main. (See p 256.)

Hotels.

Eyrie House, William Street propr., Mt. Tom
 Florence Hotel, Michael Cooney, propr., Main c Maple, Florence
 GERMANIA SINGING SOCIETY CLUB HOUSE, John Bernhardt,
 manager, Court c King. (See p 284.)
 HAMPSHIRE HOUSE, George R. Whipple, propr., Main c Strong
 av. (See p 277.)
 MANSION HOUSE, Rodney Brown, propr., 129 Main. (See p 277.)
 NONOTUCK HOUSE, E. O. Dalrymple, propr., Pearl c Pleasant.
 (See p 266.)
 Round Hill Hotel, J. D. Robinson, propr, Round Hill off Elm.

Ice Cream Manufacturers.

Hart L. R., 203 Main
 Olney M. K. Mrs., 143 and 145 Main

Ice Cream Saloon.

Jackson George, Elm n Brick Yard

Ice Dealers.

NORTHAMPTON ICE COMPANY, T. Rust & Sons, proprietors,
 163 Main. (See p 260.)
 NORWOOD ICE COMPANY, Ansel Wright manager, Opera House
 block, 120 Main. (See p 266.)

Ink, Indelible.

CLARK INDELIBLE PENCIL CO., 6 Strong av (See p 246.)
 Williston A. L., 7 King

Insurance Company—Fire.

HAMPSHIRE MUTUAL FIRE INS. CO., Kirkland's blk 52 Main
Geo. W. Hubbard, Pres. ; Oliver Walker, Secretary and Treasurer. (See p 267.)

Intelligence Office.

Tunncliffe William Mrs., Myrtle c State

Internal Revenue Collector.

Abbott Hubbard M., Hampshire and Franklin Counties, County Court House

Insurance Agents.

Fuller S. B., (fire, life and accident), N Main, Florence
Nutting Arthur F., 112 Main
PIERCE C. H., over N Inst for Savings, Main. (See p 245.)
Turner John M., Hampshire Co. Nat'l Bank bldg, 112 Main
WALKER OLIVER, 52 Main. (See p 245.)
Clarke Christopher, 3 Hawley

Iron Founders.

CLAPP CHARLES E., Pleasant c Holyoke. (See p 239.)
Couch B. M., opp Freight depot, Florence
Florence Machine Co., Main c Chestnut, Florence

Iron and Steel.

Springer John, 30 Main

Jewelers.

(See Watches, Jewelry and Clocks.)

Laundries.

ARMS GILBERT W., Bridge c Lincoln, office 72 Main. (See p 278.)
Wing Sing, 138 Main

Ladders.

Norton J. D. & Son, Loudville

Lead Pencil Manufacturers.

CLARK INDELIBLE PENCIL CO., 6 Strong av. (See p 246.)
HATHAWAY J. J., 83 South. (See p 239.)

Leather.

Baker H. H., (leather and findings), 60 Main.
 Hayes & Burby, 103 Main
 Smith H. P., 165 Main

Libraries.

Florence Public Library, Maple, Florence
 Northampton Public Library, Memorial Hall, Main
 Hampshire Law Library, County Court House

Lime and Cement.

(See Masons Materials.)

Liquors—Wholesale.

DEWEY P. H., 141 Main. (See p 283.)
 McCANDLESS WILLIAM, Masonic. (See p 283.)
 Parnell John, 6 Pleasant

Lithographer.

STAR PRINTING HOUSE, C. A. Snow, proprietor, Main c Hawley. (See p 246.)

Livery and Feed Stables.

Clapp E. C. & Bro. (sale), South
 Cooney M., Florence Hotel, Florence.
 DICKINSON & POMEROY, Center n Main. (See p 279.)
 DRAPER J. L., Mansion House Livery Stable, rear Carr's blk, Main
 (See p 279.)
 Graves Bros., Maple, Florence. (See p 259.)
 Graves Israel A., Maple, Florence
 GUILFORD R. M. & CO., Pearl c Strong av. (See p 280.)
 HOLLEY H. G. rear 206 Main, opp Masonic. (See p 282.)
 TAYLOR I. N., 15 Masonic. (See p 288.)
 Knight E. P., Henshaw av
 WHITCOMB H., Main c State. (See p 282.)
 WOOD E. T. JR., Strong av. opp Conn R R depot. (See p 280.)

Locksmith.

Bridgman O. C., 52 Main

Lumber.

- Clapp H. W., off South
 CONNECTICUT RIVER LUMBER COMPANY (manufacturers),
 Mt. Tom. (See p 241.)
 HALL E. P. & Co., Gothic. (See p 267.)
 JEWETT GEORGE D., wholesale, 90 Main. (See p 269.)
 NONOTUCK SILK COMPANY, Leeds, L. B. Field, supt. (See
 outside back cover.)
 SMITH AND LIVERMORE, Center. (See p 270.)
 WRIGHT H. A., n N H & N freight depot. (See p 267.)

Machinists and Machine Manufacturers.

- CLAPP CHARLES E., Pleasant c Holyoke. (See p 239.)
 Clement Nathan S., Florence M Co., Florence
 Couch B. M., opp freight depot, Florence
 CRYSTAL EMERY WHEEL COMPANY (emery wheel machinery),
 Hawley n Main. (See p 235.)
 HERRICK WEBSTER, bet Pleasant and R. R. av. (See p 239.)
 Knapp Dovetailing Machine Company (dovetailing machinery), Main
 c Chestnut, Florence
 MAYNARD C. A., foot Green. (See inside back cover.)
 NORTHAMPTON EMERY WHEEL COMPANY (emery wheel
 machinery), Nonotuck, Leeds. (See p 234.)

Mantels and Grates.

- KINNEY C. W., Court c King. (See p 272.)
 PRINDLE W. F., 149 Main. (See p 263.)

Marble and Granite Workers and Dealers.

- KINNEY C. W., Court c King. (See p 272.)
 Miles George N., Holyoke n R R crossing

Market Gardeners.

- Hubbard J. W., 90 Bridge
 Learned J. B., Main, Florence

Masons and Builders.

- Baker George G., 80 South
 Braman Curtis W. (stone), Hospital Hill
 BROWN & BAILEY, Gothic c Allen. (See p 271.)
 Chase Elijah & Son, Maple, Florence
 Hannum Geo. H., Franklin

Hannum John F., N Elm
 Laidley David, Fruit
 Leduc Joseph T., Water, Leeds
 MATHER JOHN L., 77 Elm. (See p 271.)
 Swift Henry & Son, Myrtle, Florence
 Willcutt George, Fruit

Masons' Materials.

BROWN & BAILEY, Gothic c Allen. (See p 271.)
 GRAVES M. L. & M. W., R R Steam Mills, Main. (See p 258.)
 SULLIVAN J. A., opp N H & N depot, Main. (See outside back cover.)

Mattress Manufacturer and Renovator.

LORD J. L., 134½ Main. (See p 278.)

Meat Markets.

Clapp & Johnson, Granite row, 109 Main
 Hebert N. Jr., Main, Leeds
 JACKSON M. W., 126 Main. (See p 262.)
 Lloyd S., 17 High, Florence
 Maine Bros., Main n Maple, Florence
 RAFTRY THOMAS, 7 Pleasant. (See p 262.)
 Ware M. H., Maple, Florence

Merchant Tailors.

(See Tailors.)

Clark Merritt & Co., 116 Main
 Jacobson L. E. & Co., Opera House blk, 118 Main
 SMITH & PRINDLE, 68 Main. (See p 252.)

Millinery.

Bon Marche, 139 Main
 Cooney & Larkin, 107 Main
 Brackett E. M. Mrs., Center, Florence
 DICKINSON C. H., 88 Main. (See p 251.)
 Harrington C. H. Mrs., Main, Leeds
 Riley John E., Davis' blk, Main, Florence
 Staplin H. R., 157 Main
 Warren E. M. & Co., 56 Main

Milk Dealers.

Meehan Dennis, South, Florence
 Phelps Albert, 90 South
 Ross Austin, Meadow, Florence

Millwright.

Couch B. M., opp freight depot, Florence

Mirror Manufacturer.

FLORENCE MFG. COMPANY, junc Nonotuck and Pine, Florence
(See p 236.)

Music and Musical Instruments.

MARSH JOSEPH (sheet music), 48 Main. (See p 255.)
STIMPSON C. N., 52 Main. (See front cover.)
WHITBECK GEO. S. & CO., 124 Main c South. (See p 247.)

Music Teachers.

Banks Kate Miss, River
Bannister Edwin Mrs., 24 Gothic
Blodgett B. C., Prospect
Burleigh Kate Mrs., Park, Florence
Clark Alice B., Clark av
Dickinson Miss, Pomeroy av
Jones Henry, teacher in Public Schools
Kenney E. M. Miss, Fruit, Florence
Mockler Kate Miss, West, Florence
Podgorski C. M., violin, 155 Main
Prince Kate Miss, Bridge
Story Edwin B., 18 Elm

News Depots.

Bird J. W., Main c Maple, Florence
CARLEY A. G., 115 Main. (See p 255.)
MARSH JOSEPH, 48 Main. (See p 255.)

Newspapers.

HAMPSHIRE COUNTY JOURNAL, Wade, Warner & Co., proprietors, Jones' blk, Court. (See p 231.)
HAMPSHIRE GAZETTE (weekly), H. S. Gere, proprietor, Gothic. (See p 230.)
HAMPSHIRE DAILY AND WEEKLY HERALD, Bridgman & Gay, proprietors, Jones' blk, Court. (See p 232.)
LE JEAN BAPTISTE, Menard, Belisle & Co., 98 Main. (See p 246.)

Nitrate of Iron Manufacturer.

KING ALBERT, office Myrtle, Florence. (See p 241.)

Notaries Public.

(See County Officers.)

Nickel Plater.

BROWN CLARENCE E., 41 Center. (See p 240.)

Nurses.

Backum John C., P. O. Box 114
 Douglass Mary A., 19 Summer
 Hutchins Sarah L., 21 Summer
 Jewell Sarah, Prospect c Spring
 Mather Sarah, 11 Clark av
 Rowland Harriet N. Miss, 7 Fruit

Nurserymen.

HOXIE D. E., office 60 Main. (See p 254.)
 Kinney C. M., Prospect

Oil Stove Manufactory.

Florence Machine Company, Main c Chestnut, Florence

Optician.

Cowing Z. D., 6 Cherry

Paints, Oils and Glass.

Branch R. M., Main, Florence
 Clark I. R., 3 Court c King
 EDWARDS O. & CO., 10v Main. (See p 256.)
 HOWARD M. C., W Center, Florence. (See p 250.)
 Jones C. H., Jones' blk, Court
 Kingsley C. B., 106 Main
 TYLER JOHN, 134 Main. (See p 278.)
 WALKER G. H. & CO. (paints and oils), 90 Main. (See p 256.)

Painters and Paper Hangers.

Bigelow Charles, Spring
 Boynton George F., N Maple, Florence
 Clark I. R., 3 Court c King
 HOWARD M. C., W Center, Florence (See p 250.)
 Jones C. H., Jones' block, Court
 Londergan John W., King
 Partridge J. H., Grant av
 Richardson W. H., Gothic

Smith George E., (grainer), 55 Gothic
 Stockwell A. H., North Farms
 Sullivan Patrick W., State ab Spring
 Sullivan P. W., 90 Main
 TYLER JOHN, 134 Main. (See p 278.)
 Whitcomb David B., Gothic n Court

Paper Dealer.

ARNOLD J. W., 90 Main. (See p 232.)

Paper Hangings.

Cutler, Plimpton & Co., Maple, Florence.
 DEARDEN WILLIAM, 32 Main. (See p 250.)
 HOWARD M. C., W Center, Florence. (See p 250.)
 Currier E. B., 15 Pleasant

Paper Box Manufactory.

KINGSBURY A. & SON, Union blk 38 Main. (See p 240.)

Packing Box Manufactories.

Smith Levi W., (lock corner), Pleasant
 Goodwin W. C., 48 N Maple c Myrtle, Florence

Paper Manufacturers.

Loud Caleb, Loudville.
 Northampton Paper Co., Vernon Bros & Co., proprietors, Paper Mill
 Village, Bay State
 Watson & Chamberlin, Loudville

Paper Mill Machinery Manufacturer.

Couch B. M., opp freight depot, Florence

Pattern Makers.

Couch B. M., opp freight depot, Florence
 CLAPP C. E., Pleasant c Holyoke. (See p 239.)
 HERRICK W., bet Pleasant and R R av. (See p 239.)
 POMEROY W. C., Center. (See p 269.)

Patturus—Ladies.

COPELAND E. P., (Harper's Bazar), 72 Main. (See p 252.)
 Ensign Henry N., (Domestic), 94 Main
 McCALLUM A., (Butterick's), 116 Main. (See p 248.)

Pen Holder Manufacturer.

CLARK EDSON P., 6 Strong av. (See p 246.)

Pencil Manufactory.

CLARK INDELIBLE PENCIL CO., 6 Strong av. (See p 246.)

Pens—Marking.

Stoddard F. H. & Co., 7 King.

Photographers.

Hardie & Schadee, 105 Main

Knowlton Brothers, Dickinson's block, 22 Main

Schillare A. J., 108 Main

Physicians and Surgeons.

Cooper Charles W., 78 Main

Cutler C. S., Main, Florence

Dunlap James, 92 Main

Fiske Samuel A., King

Gaylord E. E., Maple, Florence

Gilfillan Thomas, 104 Main

Higbee E. W., 112 Main, up stairs

Knowlton C. L., Todd's blk, 117 Main

Learned J. B., Main c Chestnut, Florence

Niquette L. B., 136 Main

PARKHURST L. B. (homeopathist), 20 Pleasant. (See p 243.)

Peet H. G., magnetic physician, 84 Main

Roberts O. O., King

Scott M. L. (homeopathist), Masonic n Center.

Seymour Christopher, 102 Main

Smith Marvin, Maple, Florence

THOMPSON A. W., Shady Lawn, Gothic. (See contents.)

Thayer George D., 92 Main

Trow Wm. M., 104 Main

Willey George A., Pine c Maple, Florence

Pianos and Organs.

Robinson J. D., Round Hill House

STIMPSON C. N., 52 Main. (See front cover.)

WHITBECK GEO. S. & CO., 124 Main. (See p 247.)

Piano Tuners and Repairers.

Kidder M. L., 124 Main

Wright Wm. K., house Prospect

Pictures, Picture Frames, &c.

Bird John W., Main c Maple, Florence
 BRIDGMAN S. E. & Co., 76 Main. (See opp inside back cover.)
 CARLEY A. G., 115 Main. (See p 255.)
 LINCOLN & BELL, 70 Main. (See p 248.)
 MARSH JOSEPH, 48 Main. (See p 255.)
 Morton L. P., (framing), 5 Union blk, 38 Main

Planing and Moulding Mills.

Clapp Henry W., off South
 Couch B. M., opp freight depot, Florence
 Florence Furniture Co., Myrtle, Florence
 Goodwin W. C., 48 N Maple, Florence
 Norton J. D. & Son, Loudville
 POMEROY W. C., Center. (See p 269.)
 Rust Stephen (planing), Loudville
 Smith Levi W., Pleasant

Plumbing.

EAMES & SPRAGUE, 24 Main. (See p 264.)
 LEE & DAY, 171 Main. (See p 263.)
 PRINDLE W. F., 149 Main. (See p 263.)
 Shumway & Riley, Park c Meadow, Florence
 WILDER SAMUEL, Maple, Florence. (See p 264.)

Pocket Book Manufactories.

Nonotuck Pocket Book Co., 9 Pleasant
 TIGERITE MFG CO., (jobbers), 34 Main. (See p 238.)

Post Offices.

Coggswell C. C., Smiths Ferry
 Cutler H. F., Postmaster, Post Office, Maple, c W Center, Florence.
 Joy L. W., Postmaster, Post Office, 123 Main
 ROSS E. S., Postmaster, Post Office, Nonotuck, Leeds.
 Watson John, Postmaster, Post Office, Loudville

Printers—Book and Job.

Bryant L. P., Main, Florence
 GAZETTE PRINTING CO., Gothic rear Savings Bank. (See opp p 49.)
 Metcalf & Co., First Nat'l Bank Bdg, Main
 STAR PRINTING HOUSE, C. A. Snow propr, Main c Hawley.
 (See p 246.)
 WADE, WARNER & CO., (Hampshire County Journal), Jones' blk Court. (See p 231.)

Publishers.

BRIDGMAN S. E. & CO., 76 Main. (See inside back cover.)
 GAZETTE PRINTING CO., Gothic rear Savings Bank. (See
 opp p 49.)
 Pearce J. S. Rev., Car Window, 74 Main
 PRICE, LEE & CO., Northampton and Easthampton Directories,
 Gazette Office

Quarry.

LANDY BROS. & CO., head of Chestnut, Florence. (See p 272.)

Railroads and Depots.

Connecticut River Railroad, steam. Passenger Station, Strong av.
 Freight Depot Strong av. N. A. Leonard, Pres. Seth Hunt,
 Treas. J. Mulligan, Supt. Walter S. Rodimon, Agent. Geo.
 E. Frink, Cashier. Wm. G. McIntyre, gen accountant. H. E.
 Howard Gen Freight Agent, Charles H. Cram, Gen Ticket
 Agent. Wm. E. Hill, Gen Baggage Agent
 New Haven and Northampton Railroad, steam. Passenger Station,
 Main c Strong av. Freight Depot, north of Main st crossing.
 E. A. Ray, Gen Ticket Agent and Treas. S. B. Opdyke, Super-
 intendent. C. H. Dakin, Station Agent. Harry Rust, freight
 clerk. A. B. Lee, ticket agent
 Northampton Street Railway, horse. Office Pearl c Strong av. E. C.
 Clark, Treasurer and Superintendent

Real Estate Agents.

PIERCE C. H., over N Institution for Savings, Main. (See p 245.)
 KELLOGG J. M., 149 Main. (See p 245.)
 Turner John M., Hamp Co. Nat'l Bank bldg, 112 Main
 WALKER OLIVER, 52 Main. (See p 245.)

Restaurants.

BERNHARDT JOHN, Court c King. (See p 284.)
 Dakin & Lee, N H & N Depot
 Edwards H. O., 135 Main
 Olney M. K. Mrs., 143 and 145 Main
 Hart L. R., 203 Main
 Pittsinger J. W., 20 Main
 Rice Henry B., Conn River Railroad Depot
 WELCH R. M., Todd's blk, Main. (See p 282.)

Saloons.

Carroll James, Hinckley, Bay State
 Carroll Matthew, 1 Masonic
 Daley P. J., Water, Florence

Dewey John T., 159 Main
 DEWEY P. H., 141 Main. (See p 283.)
 Edwards H. O., 135 Main
 Elm Street House, F. E. Dietrich, Elm junc N Elm
 GABB CHARLES N., 121 Main. (See p 283.)
 Gerhard William, Maple, Florence
 Lynch John J., Water, Florence
 McCANDLESS WILLIAM, Masonic n Main. (See p 283.)
 Parnell John, 6 Pleasant
 RUDER BRUNO, 4 King. (See p 284.)
 WELCH R. M., Todd's block, Main. (See p 282.)

Sand Dealers.

LANDY BROS, Prospect N. (See p 272.)
 PARSONS S. L. & SON, 12 West. (See p 273.)

Saw Filers.

Bridgman Oliver C., 52 Main
 Morton L. P., 5 Union block, 38 Main

Saw Mills, Circular, Mfg.

HERRICK W., bet Pleasant and R R av. (See p 239.)

Saw Mills.

Bartlett Henshaw, West Farms
 Clapp H. W., off South
 CONN. RIVER LUMBER CO., Mt. Tom. (See p 241.)
 Day N. & Bros., South opp Hospital Hill
 NONOTUCK SILK CO., L. B. Field supt., Leeds. (See outside
 back cover.)

Seed Stores.

Bartlett E. H., Clark av
 EDWARDS O. & CO., 100 Main. (See p 256)
 ROSS E. S., Nonotuck, Leeds. (See p 261.)
 SULLIVAN J. A., opp N H & N depot, Main. (See outside back
 cover
 WRIGHT D. J., Union block, 36 Main. (See p 255.)

Schools—Private.

Burnham Mary A. Miss, 17 Elm. Prepares young ladies for Smith
 College
 Clark Lizzie and Mary K., (kindergarten), Opera House blk, 120 Main
 Clark I. G. and H. M. Misses, 58 Elm
 Florence Kindergarten, Miss Carrie T. Haven, Pine, Florence

Sewing Machine Agents.

Barrett E. T., 107 Main
 Bartley P., South, Florence
 COPELAND E. P., general agency for all kinds of sewing machines,
 72 Main. (See p 252.)
 Day F. B., Wheeler & Wilson, Arlington
 Ensign Henry N., 94 Main, Domestic
 Fuller D. L., agt W & W Mfg Co., 13 Pleasant
 McCormick E. R., Household, 113 Main

Sewing Machine Manufacturers.

Florence Machine Co., Main c Chestnut, Florence

Silk Manufacturers.

BELDING BROS & CO., 27 Hawley. (See outside front cover.)
 NONOTUCK SILK CO., Nonotuck, Florence and Leeds. (See outside back cover.)
 WARNER LUTHER J., Elm n Florence line. (See p 237.)

Silver and Silver Plated Ware.

BROWN CLARENCE, 41 Center. (See p 240.)
 Cook B. E. & Son, 80 Main
 DEARDEN WILLIAM, 32 Main. (See p 250.)
 Hathaway A. E., 131 Main.
 HOXIE D. E., 60 Main. (See p 254.)
 SKIFF J. M., 119 Main. (See p 255.)

Silver Plater.

BROWN CLARENCE E., 41 Center. (See p 240.)

Soap Manufacturers.

Barrett E. S., off Bates
 Sawyer Amos, Locust, towards Florence

Soda Water Manufacturer.

Boynton W. W., River

Spool and Bobbin Manufacturers.

NONOTUCK SILK CO., Leeds. (See outside back cover.)

Stage Lines.

Amherst, Hadley and Northampton, E. F. Cook, office Mansion House
 Northampton, Florence, Leeds, Haydenville and Williamsburg stage,
 H. S. Chapman, 100 Main
 Northampton, Hadley and N Hadley stage, C. B. Sanderson, 26 Main
 Northampton, Huntington, Westhampton and Loudville stage, H. S.
 Rhodes, office Clark & Parsons' drug store, 125 Main

Stair Builder.

POMEROY W. C., Center. (See p 269.)

Steam and Gas Fitters.

EAMES & SPRAGUE, 24 Main. (See p 264.)
 LEE & DAY, 171 Main. (See p 263.)
 PRINDLE W. F., 149 Main. (See p 263.)
 Shumway & Riley, Park c Meadow, Florence
 WILDER SAMUEL, Maple, Florence. (See p 264.)

Steamship Ticket Agents.

Cardinal John B., Nonotuck, Leeds
 Carroll Matthew, 1 Masonic,
 Clapp E. I., 10 Main
 Dewey H. W., (White Star), 26 Main
 Drury S. Dwight, N Inst for Savings, Main
 McCANDLESS WILLIAM, Masonic n Main. (See p 283.)
 MENARD ADOLPHE, (Allen Line), 98 Main. (See p 246.)
 O'Donnell & Herlihy, Water, Florence
 Rodimon W. S., Conn R R Depot
 SULLIVAN JOHN A., Main opp N H & N Depot. (See outside
 back cover.)
 WALKER OLIVER, Kirkland's block, 52 Main. (See 245.)

Stoves and Tin Ware.

EAMES & SPRAGUE, 24 Main. (See p 264.)
 LEE & DAY, 171 Main. (See p 263.)
 PRINDLE W. F., 149 Main. (See p 263.)
 Shumway & Riley, Park c Meadow, Florence
 WILDER SAMUEL, Maple, Florence. (See p 264.)

Stucco Workers.

BROWN & BAILEY, Gothic c Allen. (See p 271.)
 Hannum George H., Franklin
 MATHER JOHN L., Elm n Massasoit. (See p 271.)

Surveyor.

Davis E. C., 114 Main

Tack Manufacturers.

Florence Tack Co., Locust c Holyoke, Florence

Tailors—Repairing.

Assing August, Maple, Florence
KAISER F. W., State. (See p 278.)
Nichols E. W., 117 Main
Paquin N., 82 Main

Tape Manufacturers.

DAMON NARROW FABRIC CO., Pleasant c Strong av. (See p 237.)
Shannon James H., Smiths Ferry

Telegraph Offices.

Western Union Telegraph Co., Conn R R R Passenger Station, J. H.
Rankin, operator
Western Union Telegraph Co., W. L. Wilcox, operator, depot, F

Telephone Office.

Bay State Telephone Co., A. E. Cross, Manager, 92 Main

Telephone Pay Stations.

Bird J. W., Main c Maple, Florence
WALKER GEORGE H. & CO., 90 Main. (See p 256.)

Tin Peddler.

Ladd Harlow, Union, Bay State

Tobacco Warehouses.

Graves & Cooley, Strong av n Conn R R R depot
Graves & Tucker, Main, next to railroad.
Thayer C. L., Franklin av

Tripe Manufacturer.

Sawyer Amos, Locust, Florence

Truckmen.

(See Expressmen.)

Trunks, Valises and Traveling Bags.

Cohn S., 44 Main
 Clark Merritt & Co., 110 Main
 Cutler, Plimpton & Co., Maple, Florence
 FRENCH M. M. & CO., 82 Main. (See p 253.)
 Hayes & Burby, 103 Main
 Moore Lincoln B., Maple, Florence
 PARSONS H. K., Maple c Main, Florence. (See p 253.)
 SHERWIN A., 18 Main. (See outside front cover.)
 STOCKER A. H. & CO., 96 Main. (See p 251.)

Undertakers.

Orcutt T. A., Maple, Florence
 PARNELL JOHN, Walter J. Forestall manager, Strong av opp N H
 & N R R depot. (See p 247.)
 SACKETT R. W. & J. R., 2, 4 & 6 King. (See p 253.)
 SEARLE & EDWARDS, Center, rear First Church. (See back cover.)
 SMITH W. L. & CO., 8 to 11 Court. (See inside front cover.)

Vinegar Manufacturer.

Smith Charles H., Smiths Ferry

Veterinary Surgeons.

Pollard Wm. H., 90 Main, Northampton, bds Florence Hotel, F
 Wood E. T., Strong av, opp R R depot

Watches, Jewelry and Clocks.

Cook B. E. & Son, 80 Main
 Hathaway A. E., 131 Main
 HOXIE D. E., 60 Main. (See p 254.)
 ROBERTS E. A., 54 Main. (See p 254.)
 SKIFF J. M., 119 Main. (See p 255.)
 Smith Wm. M., Davis blk, Main, Florence

Water Wheels—Turbine.

Couch B. M., near freight depot, Florence

Wire Manufacturers—Iron and Tinned.

LAMB HORACE & CO., Clark av. (See p 238.)

Western Loan Funds.

Edwards H. L., 108 Main

Wood Dealers.

(See Coal and Wood.)

Wood Turning.

Couch B. M., opp Freight depot, Florence
Goodwin W. C., 48 N Maple, Florence
Norton J. D. & Son, Loudville
POMEROY W. C., Center. (See p 269.)
Smith Levi W., Pleasant

Wood Working Machinery.

Knapp Dovetailing Machine Co., Main c Chestnut, Florence
Couch B. M., opp freight depot, Florence

Yeast Peddler.

Wheeler W., 11 Masonic

Town Government.

TOWN OFFICERS,

Selectmen, Assessors and Overseers of the Poor, Oran Storer, Chauncey H. Pierce, Mark H. Spaulding.

Clerk, J. A. Sullivan.

Collector and Treasurer, Hiram Day.

Elector, Lewis Warner.

School Committee, Rev. A. C. Hussey, Rev. E. G. Cobb.

Constables, Ansel Wright, Edward Bridgman, James Quirk, Eleazer Bryant, R. Gilbert, F. G. Richards, Luke Day, Thomas Shea, Chas. Loomis.

Police, H. E. Maynard, M. W. Powers, J. J. Raleigh, Wm. E. Partridge, Felix Laframboise, George F. Boynton.

Special Police, Wm. A. Bailey, W. S. Rodimon, T. A. Orcutt, Chas. W. Loomis, Daniel Sheehan, Calvin Kingsley, Sylvester C. Wait, H. E. Maynard, O. J. Damon, E. J. Wrisley.

Railroad Police, J. R. Hillman, Thos. Kiley, W. S. Rodimon, W. J. Landry, James W. Hillman.

Keeper of Lock-up, F. G. Richards.

Commissioners of Sinking Fund, Henry F. Williams, William Allen, W. M. Gaylord.

Library Committee, Wm. M. Gaylord, A. L. Williston, H. F. Williams.

Almoners of Whiting Street Poor Fund, George H. Ray, Chiara A. Plimpton, Mary Lyman, J. R. Trumbull.

Surveyors of Lumber, Roland S. Bartlett, Levi W. Smith, B. M. Couch, Lemuel B. Field, Henry W. Clapp, Walter C. Goodwin, Walter M. Tower.

Field Driver, E. C. Bosworth.

Tything-men, John A. Prentiss, George P. Campbell.

Fence Viewer, Julius Phelps.

Surveyor of Highways, B. H. Stone.

Weighers of Hay, Coal &c., Wm. M. Robbins, W. C. Goodwin, John P. Joy, L. B. Field, H. K. Parsons, J. W. Bird, S. W. Lee, Jr.

Auditors, J. M. Kellogg, B. E. Cook, Jr., Geo. W. Clark.

Committee on Trust Funds and Trust Property, J. L. Warriner, Luther Bodman, H. F. Williams,

Measurers of Wood, &c., S. J. Bosworth, W. C. Goodwin, S. W. Lee, Jr., Ira O. Lamson, L. B. Field, John P. Joy, J. A. Sullivan, Albert E. Marsh.

Committee on Cemetery, M. M. French, S. M. Smith, W. F. Prindle.

Committee to Lease Town Lands, Enos Parsons.

Day Police, Edward Bridgman.

Truant Officer, Edward Bridgman.

Probation Officer, Edward Bridgman.

Board of Health, T. G. Spaulding, George P. Warner, Charles W. Cooper.

FIRE DEPARTMENT.

BOARD OF ENGINEERS.

Chief Engineer, Lewis Warner ; *1st Assistant*, Levi I. Clark ; *2d Assistant*, George H. Smith ; *Vetile Francis*, C. C. Walbridge, E. E. Wood ; *Secretary*, W. C. Robinson.

JOHN TAPPAN STEAMER, No. 1.—Frank L. Clapp, *Engineer*.

HOOK AND LADDER CO. No. 1.—Charles A. Kellogg, *Foreman* ; Wm. F. Knapp, *Clerk*.

HOSE COMPANY, No. 1.—Wm. A. Bailey, *Foreman* ; George H. Daniels, *Clerk*.

HOSE COMPANY, No. 2.—Felix Barry, *Foreman* ; Oliver Dragon, *Clerk*.

HOSE COMPANY, No. 4.—M. H. Kiley, *Foreman* ; M. D. Shea, *Clerk*.

HOSE COMPANY, No. 5.—J. J. Raleigh, *Foreman* ; Herbert Kellogg, *Clerk*.

HOSE COMPANY, No. 6.—Wm. H. Riley, *Foreman* ; W. H. Titcomb, *Clerk*.

HOSE COMPANY, No. 7.—Fred E. Chase, *Foreman* ; John W. Bird, *Clerk*.

TORRENT ENGINE COMPANY, No. 8.—C. G. Robbins, *Foreman* ; John Q. Adams, *Clerk*.

HOSE COMPANY, No. 3.—Spare reel, I. N. Taylor, *Driver*.

NORTHAMPTON WATER WORKS.

The construction of these works was commenced in May, 1871, and completed the following fall. The water is taken from Roberts Meadow, one-half mile west of Leeds. There is a fall of 90 feet in Florence, 220 feet at the Old Church in the Center, and 240 feet at the Conn. R. R. depot. There is now laid $25\frac{1}{2}$ miles and 1,456 feet of pipe, at a cost of \$210,751.10. In 1880, there were 1186 takers; in 1881, 1278. *Commissioners*, J. S. Lathrop, term expires 1886; Benj. E. Cook, Jr., 1886; Daniel W. Bond, 1884; Oscar Edwards, 1884; Lucius Dimock, 1885; H. F. Williams, 1885. D. W. Bond, *Prest*; H. F. Williams, *Clerk*; Jonas M. Clark, *Supt.*, office, Town Hall; Oscar Edwards, *Treas.*

PUBLIC SCHOOLS.

SCHOOL COMMITTEE.—William D. Clapp, term expires, 1885; T. G. Spaulding, 1885; Charles N. Clark, 1884; Miss Mary W. Bond, 1884; Rev. A. C. Hussey, 1886; Rev. E. G. Cobb, 1886.

SUPERINTENDENT.—George B. Drury; office in Town Hall. Office hours in school session from 8 to 9 A. M.; Saturdays, 9 to 12.

TEACHER OF MUSIC.—Prof. Henry Jones; residence, Elm street.

SCHOOLS AND TEACHERS.

HIGH SCHOOL.—D. D. Gorham, *Principal*; Isaac M. Agard, *1st Assistant*; Ida C. Bannister, *2d Assistant*; Laura E. Love, *3d Assistant*; Delia Cook, *Teacher of French*.

FLORENCE HIGH SCHOOL.—George A. Hoadley, *Principal*; Julia A. Kelley, *Assistant*.

GRAMMAR SCHOOLS.—Sarah M. Burt, *Center*, No. 1; L. C. Patterson, No. 2; Sarah E. Watkins, No. 3; Emma L. Hamilton, No. 4; M. H. Whipple, No. 5; Ella Payne, No. 6; Emma C. Kellogg, No. 7. Mary E. Dean, *Bay State*. Lizzie M. Ingram, *Florence*, No. 2; Sarah E. Martin, No. $2\frac{1}{2}$; Sarah M. Ewing, No. 3; Miss E. A. Burtch, ungraded. Albert L. Dyer, *Leeds*. Lizzie H. Clark, Bridge Street Grammar, No. 1; Anna H. Doolittle, No. 2

GRADED PRIMARY.—Sarah C. Strong, *Center*, No. 1; Helen E. Woodward, No. 2; Lizzie L. Kingsley, No. 3; Alice E. Spear, No. 4; Emma S. Dowie, Elm street; Mary E. Cobb, assistant, Elm Street;

Agnes S. Freeman, Prospect street ; Sarah E. Owen, King Street ; Mary J. Strong, Bridge Street Primary, No. 1 ; Lizzie M. Irwin, No. 2 ; Abbie A. Irwin, No. 3 ; Stella C. Elwell, Williams, No. 1 ; Hattie H. Pratt, No. 2 ; Clara A. Lewis, South street, No. 1 ; Lottie A. Kellogg, No. 2 ; Hattie E. Strong, South street South ; Lizzie H. Taylor, Hospital Hill ; Nellie M. Guilford, Paper Mill ; Myra E. Kingsley, *Bay State*, No. 1 ; Clara R. Dean, No. 2 ; Annie Hill, No. 3 ; Anna E. Estabrook, *Florence*, No. 1 ; Fanny K. Rust, No. 2 ; Mary L. Taylor, No. 3 ; Alice E. Warner, No. 4 ; Lizzie M. Warren, No. 5 ; Nellie K. Warner, No. 6 ; Carrie J. Partenheimer, *Leeds*, No. 1 ; Mary E. Robbins, No. 2 ; Mary A. Clark, No. 3 ; Mattie Warren, No. 4.

UNGRADED SCHOOLS.—Kate A. Deady, Catholic Cemetery ; Hattie Warner, North Farms ; Hattie B. Allen, Roberts Meadow ; Esther M. Carver, West Farms ; Sarah A. Whitmarsh, Loudville ; Effa Fiske, Pine Grove ; Anna R. Edwards, Smiths Ferry.

JANITORS.—Silas A. Wright, Center High School ; A. P. Bridgman, Florence High School.

CHURCHES.

FIRST CONGREGATIONAL CHURCH.

Corner Main and Center Streets.

Pastor, Rev. Herbert W. Lathe, 18 Bridge Street ; *Deacons*, Chas. B. Kingsley, Daniel D. Gorham, Silas M. Smith, George L. Wright, A. Lyman Williston, Wm. P. Strickland, John B. Clark, Enos Clark ; *Church Clerk*, H. K. Dickinson ; *Church Treasurer*, C. B. Kingsley ; *Superintendent of Sabbath School*, S. D. Hadley ; *Assistant Superintendent*, Miss Sarah Burt ; *Librarian*, E. P. Copeland ; *Assistant Librarian*, A. H. Stocker ; *Society Committee*, George L. Wright, Oscar Edwards, Henry F. Williams ; *Society Clerk*, H. M. Abbott ; *Society Treasurer*, Jos. M. Kellogg ; *Collector*, Jos. M. Kellogg ; *Musical Director*, John Prince ; *Organist*, S. W. Lee, Jr. ; *Sexton*, John A. Prentiss. Preaching at 10.30 A. M., and 7.30 P. M. Sabbath School after morning service.

EDWARDS CHURCH.

Corner Main and State Streets.

Pastor, Rev. Isaac Clark ; *Deacons*, William H. Stoddard, Addison J. Lincoln, William H. Jones, Sidney E. Bridgman, George Tucker ; *Church Clerk*, William H. Stoddard ; *Church Treasurer*, William H.

Stoddard ; *Superintendent of Sabbath School*, Sidney E. Bridgman ; *Assistant Superintendent*, F. N. Kneeland ; *Librarian*, John Mather ; *Society Committee*, J. C. Hammond, Henry M. Tyler, John Sullivan, Henry S. Gere, H. G. Mavnard ; *Society Clerk*, S. Dwight Drury ; *Society Treasurer*, Edward H. Bell ; *Collector*, Edward H. Bell ; *Organist*, E. B. Story ; *Sexton*, Augustus Graves. Preaching at 10.30 A. M., and 7.30 P. M. Sabbath School at 12 M.

FIRST CONGREGATIONAL CHURCH.

Florence.

Pastor, Rev. Elisha G. Cobb ; *Deacons*, A. C. Estabrook, W. L. Wilcox, W. M. Smith, E. W. Barnard, George A. Ray ; *Clerk of Church*, W. L. Wilcox ; *Superintendent of Sabbath School*, W. H. Riley ; *Librarian*, Arthur M. Ware ; *Society Committee*, A. C. Estabrook, William H. Riley, William Fulton, Ezra Brackett, Samuel Wilder ; *Society Clerk*, Thomas A. Orcutt ; *Treasurer*, E. H. Barnard ; *Collector*, Theo. E. Hough ; *Organist*, Miss Kate Ranney ; *Leader of Choir*, Mrs. T. E. Hough.

FREE CONGREGATIONAL CHURCH.

Cosmian Hall, Florence.

Resident Speakers, W. H. Spencer, Anna Garlin Spencer ; *Treasurer*, A. T. Lilly ; *Clerk*, H. G. Thompson ; *Superintendent of Sabbath School*, W. H. Spencer ; *Executive Committee*, Seth Hunt, A. T. Lilly, Joseph Marsh. Lecture at 2 P. M. Sabbath School at 10.30 A. M.

BAPTIST CHURCH.

Main Street, opp. Elm Street.

Pastor, Rev. A. C. Hussey, 214 Main ; *Deacons*, C. T. Lee, E. J. Cornwell, J. R. Clemons, A. S. Ballou, O. E. Livermore ; *Society Treasurer*, M. L. Graves ; *Society Clerk*, G. L. Loomis ; *Church Treasurer*, B. H. Stone ; *Clerk*, J. A. Woodruff ; *Superintendent of Sabbath School*, O. E. Livermore ; *Organist*, J. E. Clemons ; *Sexton*, Charles H. Bigelow. Preaching at 10.30 A. M. Sabbath School at close of morning service.

METHODIST CHURCH.

Center Street, opp. Masonic.

Pastor, Rev. W. H. Meredith, Washington av ; *Treasurer*, Chauncey W. Rowley ; *Trustees*, Henry N. Ensign, Edward S. Barrett, Harry A. Kimball ; *Superintendent of Sabbath School*, C. W. Rowley ; *Sexton*, Frank Rowley. Preaching at 10.30 A. M. Sabbath School after morning service.

M. E. CHURCH.

Florence, Corner Main and Park Streets.

Pastor, Rev. Allen J. Hall ; *Trustees*, H. K. Parsons, G. F. Miller, C. Humphrey, D. W. Goodell, C. Damon, J. A. Bray, F. W. Moore, Martin Chapin ; *Clerk*, C. Humphrey ; *Treasurer*, A. Back ; *Superintendent of Sabbath School*, Rev. Allen J. Hall ; *Sexton*, W. H. Lanphear. Sabbath School at 10.30 A. M. Preaching at 2 P. M.

UNITARIAN CHURCH.

Main Street.

Pastor, ———— ; *Treasurer*, W. H. Clapp ; *Superintendent of Sabbath School*, Frank I. Washburn ; *Clerk*, E. H. Banister ; *Standing Committee*, Stephen Barker, Ansel Wright, Miss Mary Lyman ; *Music Committee*, Frank I. Washburn ; *Librarian*, Thomas Shepherd ; *Sexton*, F. G. Richards. Preaching at 10.30 A. M. Sabbath School at close of morning service.

EPISCOPAL CHURCH.

Bridge Street, opp. Hawley.

Rector, Rev. J. Sturgis Pearce, Bridge street ; *Wardens*, W. C. Robinson, D. W. Crafts ; *Treasurer*, Lewis Warner ; *Superintendent of Sabbath School*, W. C. Robinson ; *Vestry*, Lewis Warner, Edwin C. Clapp, E. I. Clapp, S. W. French, E. E. Gaylord.

HOSPITAL HILL MISSION SABBATH SCHOOL.

Meetings at 3 P. M.

BAY STATE SABBATH SCHOOL.

Superintendent, W. R. Holliday. Meeting at 5 P. M.

LEEDS CONGREGATIONAL CHAPEL SABBATH SCHOOL.

Superintendent, George H. Ray. Meeting at 1.15. Preaching at 2.30 P. M. by Rev. E. G. Cobb.

ST. MARY'S R. C. CHURCH

King Street.

Pastor. Rev. M. E. Barry, Hawley street. *Assistant,* Rev. M. J. Carroll, Hawley street.

CHURCH OF THE IMMACULATE CONCEPTION, R. C.

Florence.

Pastor, Rev. P. F. Callery; *Assistant,* Rev. John McMahon.

MASONIC.

JERUSALEM LODGE, F. & A. M.

Regular Communications Tuesdays preceding full moon in each month.

Officers.—Frank L. Clapp, *W. M.*; Henry Jones, *S. W.*; Charles H. Boyden, *J. W.*; J. H. Prindle, *Treas.*; John A. Prentiss, *Secretary*; Carlos Humphrey, *Chaplain*; Samuel A. Phelps, *Marshal*; Edward E. Gaylord, *S. D.*; Frank I. Washburn, *J. D.*; William A. Coburn, *S. S.*; Wallace A. Mann, *J. S.*; John R. Hillman, *Tyler.*

NORTHAMPTON R. A. CHAPTER

Regular Convocations on the first Wednesday in each month.

Officers.—Lemuel B. Field, *M. E. H. P.*; Carlos Humphrey, *E. K.*; James Ellsworth, *E. S.*; Ansel Wright, *Treasurer*; William C. Robinson, *Secretary*; Samuel A. Phelps, *C. H.*; Frank L. Clapp, *P. S.*; Geo F. Crittenden, *R. A. C.*; Wm. B. Morgan, *M. 3d V.*; D. A. Hemenway, *M. 2d V.*; W. L. Clark, *M. 1st V.*; Stephen B. Fuller, *Chaplain*; D. W. Crafts, *S. S.*; S. W. Lee, *J. S.*; John R. Hillman, *Tyler.*

NORTHAMPTON COMMANDRY OF KNIGHTS TEMPLAR.

Regular Conclaves Second Monday in each month.

Officers.—John L. Otis, *E. C.*; Wm. B. Morgan, *G.*; James Ellsworth, *C. G.*; Carlos Humphrey, *Prelate*; John Strong, Jr., *S. W.*; Wm. C. Robinson, *J. W.*; Ansel Wright, *Treasurer*; Louis B. Graves, *Rec.*; E. A. Brooks, *Sw. B.*; John A. Prentiss, *St. B.*; Frank L. Clapp, *War.*; L. B. Field, *Musical Dir.*; A. Witherell, *D. A. Hemenway*, *W. S. Rodimon*, *Guards*; John R. Hillman, *Sent. and Arm.*

I. O. O. F.

NONOTUCK LODGE, NO. 61.

Meets every Thursday evening at Odd Fellows' Hall.

Orrin E. Livermore, *N. G.* ; Frank W. Woodward, *V. G.* ; E. H. Wade, *Rec. Sec'y* ; E. B. Strong, *Per. Sec'y* ; E. P. Hall, *Treasurer* ; A. P. Hancock, *W.* ; J. W. Palmer, *C.* ; Myron Ray, *R. S. N. G.* ; Wm. P. Childs, *L. S. N. G.* ; John W. Draper, *R. S. V. G.* ; Fred. Radio, *L. S. V. G.* ; C. B. Macomber, *R. S. S.* ; Charles R. Farr, *L. S. S.* ; G. L. Harris, *Chaplain.*

MT. HOLYOKE ENCAMPMENT.

Meets 2d and 4th Monday evening of each month, at Odd Fellows' Hall.

Myron Ray, *C. P.* ; D. F. Cutting, *H. P.* ; Emerson Bates, *S. W.* ; D. A. Graves, *J. W.* ; Edward H. Wade, *Scribe* ; Thomas Bridgman, *Treas* ; F. W. Woodward, *Guide* ; C. B. Macomber, *I. S.* ; A. S. Goodell, *O. S.* ; R. B. Davis, Jr., *1st W.* ; A. H. Stocker, *2d W.* ; J. W. Palmer, *3d W.* ; R. L. Wilhelmi, *4th W.* ; D. C. Robbins, *1st G. of T.* ; A. M. Locke, *2d G. of T.*

KNIGHTS OF HONOR.**FLORENCE LODGE K. OF H., NO. 1207, FLORENCE.**

Meets 2d and 4th Wednesday evenings of each month.

W. M. Smith, *Past Dictator* ; Dr. E. E. Gaylord, *Dictator* ; W. P. Abbott, *V. Dictator* ; O. M. Smith, *Reporter* ; C. A. Huxley, *Fin. Reporter* ; George H. Olds, *Treasurer* ; L. J. Ranney, *Guide* ; H. W. Sanford, *Chaplain.*

GRAND ARMY OF THE REPUBLIC.**W. L. BAKER POST, NO. 86, G. A. R.**

Meets at Southwick Hall, 1st and 3d Fridays of each month.

W. C. Pomeroy, *Commander* ; John Keach, *S. V. Commander* ; Wm. H. Pepper, *J. V. Commander* ; E. I. Clapp, *Q. M.* ; Charles H. Heald, *Sergt. Major* ; N. S. Cornwell, *Adjutant* ; W. B. Welton, *Chaplain* ; Jere Brown, *Q. M. S.* ; William R. Bardwell, *O. D.* ; Thomas Gilfillan, *Surgeon.*

CATHOLIC KNIGHTS OF AMERICA.

Florence.

President, Martin L. Hunt ; *Vice President*, Frank O'Connell ; *Rec. Secretary*, Daniel D. O'Donnell ; *Fin. Secretary*, Joseph Bethune ; *Treasurer*, Thomas Herlihy ; *Sergt. at Arms*, Patrick W. Crotty ; *Trustees*, Charles E. Lovett, Michael Tobin, John Shannon.

MISCELLANEOUS SOCIETIES.

HAMPSHIRE, HAMPDEN AND FRANKLIN AGRICULTURAL SOCIETY.

Organized 1818 ; *President*, Jonathan D. Porter, of Hatfield ; *Secretary*, L. C. Ferry, of Northampton ; *Treasurer*, David J. Wright, of Northampton ; *Executive Committee*, Samuel B. Parsons, of Northampton ; F. K. Sheldon, of Southampton ; E. M. Smith, of Deerfield ; *Delegate to State Board of Agriculture*, H. C. Haskell, of Deerfield.

NORTHAMPTON CLUB.

Rooms, First National Bank Building.

John L. Otis, *Pres* ; Lucien B. Williams, Wm. P. Strickland, Henry L. James, Timothy G. Spaulding, *Vice Presidents* ; E. M. Meekins, *Sec'y* ; Lewis Warner, *Treas.* ; H. F. Williams, J. M. Turner, L. J. Warner, Wm. H. Clapp, Lucius Dimock, C. H. Pierce, E. H. Banister, George G. Baker, *Executive Committee* ; H. P. Billings, Daniel Pickard, Frank E. Clark, H. M. Abbott, John F. Stoddard, *Election Committee*.

FRENCH DRAMATIC CLUB.

Meets in St. John Baptiste Society Hall, first Sunday of each month.

Acting President, G. Marcille ; *Sec'y and Treas.*, A. Menard.

ST. JOHN BAPTISTE SOCIETY.

Meets at St. John Baptiste Society Hall, first Wednesday of each month.

President, O. Dragon ; *Vice President*, A. Bisailon ; *Secretary*, L. B. Niquette ; *Treasurer*, A. Menard.

L'UNION LITTERAIRE DES OUVRIERS.

Society Rooms over E. A. Brooks' store, Main Street.

President, F. X. Duchesne ; *Cor. Sec'y*, F. X. Menard ; *Treasurer*, Louis Hebert.

NORTHAMPTON COUNCIL, NO. 202.—A. L. of H.

Meets at Southwick Hall first and third Mondays of each month.

Commander, George H. Smith ; *Vice Com.*, Alfred E. Steele ; *Sec'y*, C. C. Tracy ; *Collector*, Geo. S. Gere ; *Treas.*, M. L. Graves.

FIRST DIVISION OF NORTHAMPTON.—A. O. of H.

Meets at Maloney's Hall first Thursday of each month.

President, Wm. Godfrey ; *Vice Pres.*, Stephen Connolly ; *Financial Sec'y*, John White ; *Recording Sec'y*, Andrew Green ; *Treas.*, Matthew Carroll.

FLORENCE DRAMATIC CLUB.

President, G. A. Jencks ; *Sec. and Treas.*, E. S. Bottum ; *Manager*, A. G. Hill.

THE LEEDS READING CLUB.

President, William Souter ; *Treasurer*, William Singleton ; *Committee*, William Walsh, John Burk, Anthony Young, Chandler Robbins, Luke Tyler, Frank Baker.

FLORENCE TOTAL ABSTINENCE SOCIETY.

President, Arthur G. Hill ; *Vice President*, Frank H. Grover ; *Secretary*, Ernest Porter.

FATHER MATTHEW T. A. B. SOCIETY.

Meets first and third Tuesday evenings of each month, at Temperance Hall, Williams' Block.

President, R. P. Dalton ; *Vice Pres.*, James Ahearn ; *Treas.*, Wm. Kiley ; *Sec'y*, John Wade.

FATHER MATTHEW T. A. B. SOCIETY.

Florence.

President, James T. Hickey; *Vice Pres.*, Michael Tobin, West street; *Secretary*, James O'Brien; *Asst. Sec'y*, Michael Hall; *Treasurer*, Thomas Colgan.

VILLAGE IMPROVEMENT SOCIETY.

President, Benjamin S. Lyman; *Vice Presidents*, Prof. H. M. Tyler, Rev. J. S. Pearce, S. L. Parsons, Rev. C. B. Ferry; *Recording Secretary*, C. F. Warner; *Corresponding Secretary*, Miss Sarah B. Thayer; *Treasurer*, S. D. Drury; *Executive Committee*, H. K. Dickinson, Charles N. Clark, Prof. B. C. Blodgett, Dr. O. O. Roberts, Joseph Marsh, D. J. Wright, C. F. Warner, J. H. Demond, A. L. Williston, Mrs. Henry Lathrop, Miss L. O. Damon, Mrs. J. H. Butler, Miss Mary Lyman, Miss Fanny Brewer, Mrs. Oscar Edwards, Mrs. L. E. Washburn.

STEBUBEN LODGE, D. O. H.

Meets second Tuesday of each month at Southwick Hall.

O. B., Charles Ziehlke; *U.*, Fred Schneider; *Secretary*, Richard Forster; *Treasurer*, Jacob Sauter.

PUBLIC INSTITUTIONS.
NORTHAMPTON FREE PUBLIC LIBRARY.

Established, 1860; Whole No. Vols., 17,161. In 1868, the lot on which the present building is located, was purchased, and in 1872-3 the building was constructed, at a total cost of \$77,249. On the 30th of March, 1874, the library was opened to the public. The Reading Room is supplied with all the leading papers and magazines. *Chairman*, Wm. P. Strickland; *Sec'y*, J. R. Trumbull; *Treas.*, H. M. Abbott; *Library Committee*, W. P. Strickland, D. W. Bond, J. R. Trumbull; *Executive and Finance Committee*, J. R. Trumbull, W. P. Strickland, W. M. Gaylord, C. Clarke; *Com. on Building and Grounds*, A. L. Williston, W. M. Gaylord, C. Clarke, H. M. Abbott,

H. F. Williams ; *Com. on Donations*, A. T. Lilly, A. L. Williston, C. Clarke ; *Com. on Florence Branch*, A. T. Lilly, W. P. Strickland, D. W. Bond ; *Librarian*, Miss Caroline S. Laidley ; *First Asst.*, Miss Margaret Ralston ; *Second Asst.*, Miss Julia M. Laidley ; *Janitor*, Norman S. Cornwell. Library hours, every week-day, except holidays, from 9 o'clock A. M. to 8 o'clock, P. M. Saturday evening to 9 o'clock. On Sundays, from 1 o'clock to 8 o'clock, P. M. Reading Room Hours, every week-day, except holidays, from 9 o'clock, A. M. to 9 o'clock, P. M. On Sundays, from 1 o'clock to 9 o'clock, P. M.

FLORENCE BRANCH.

Librarian, Miss Mary Fuller. Hours, every week-day, except holidays, from 2 to 5 o'clock, P. M. Reading Room in connection.

SMITH COLLEGE

The Smith Female College was founded and endowed by Miss Sophia Smith, of Hatfield, who died in 1870, bequeathing for that purpose an estate valued at \$386,608 ; to which, by the terms of the Will, the town added \$25,000. The property now amounts to over \$500,000. The College was dedicated July 14, 1875. It stands on the site of the Judge Lyman homestead, on Elm street, facing Main street. An Art Gallery has recently been added, and Winthrop Hillyer, of this town, donated the handsome sum of \$30,000 for the erection of an Art Building, and also left a bequest of \$50,000 for its permanent endowment.

FACULTY AND INSTRUCTORS.

Rev. L. Clark Seelye, D. D., President.
 Rev. Henry M. Tyler, M. A., Professor of Greek.
 Rev. Geo. N. Webber, D. D., Prof. of Mental and Moral Philosophy.
 John T. Stoddard, Ph. D., Prof. of Chemistry and Physics.
 John B. Clark, M. A., Prof. of History and Political Science.
 Benj. K. Emerson, Ph. D., Prof. of Geology and Mineralogy.
 David P. Todd, M. A., Teacher of Astronomy.
 Benj. C. Blodgett, Mus D., Prof. of Music.
 John H. Niemeyer, M. A., of Yale Art School, Teacher of Drawing and Painting.
 Miss Heloise E. Hersey, Teacher of Rhetoric and Anglo-Saxon.
 Miss Harriet J. Williams, Teacher of Latin.
 Mlle. Louise Both-Hendriksen, Teacher of French.
 Frau Marie F. Kapp, Teacher of German
 Miss Mary E. Ellis, Teacher of English Literature.
 Miss Eleanor P. Cushing, teacher of Mathematics.
 Miss Ruth Hoppin, Teacher of Biology and Botany.
 Miss Ludella L. Peck, Teacher of Elocution and Gymnastics.

Miss Essie J. Watson, Assistant in English.
 Miss Ella E. Eaton, Assistant in Physics and Chemistry.
 Mrs. Elizabeth J. Hopkins, in charge of the Dewey House.
 Miss Fanny A. Dart, in charge of the Hubbard House.
 Miss Fanny C. Hesse, in charge of the Hatfield House.
 Miss Louise Ostram, in charge of the Washburn House.

BOARD OF TRUSTEES.

Rev. L. Clark Seelye, D. D., President.
 Rev. John M. Greene, D. D., of Lowell.
 Rev. William S. Tyler, D. D., LL. D., Professor at Amherst.
 Rev. Julius H. Seelye, D. D., LL. D., President at Amherst.
 Hon. William B. Washburn, LL. D., of Greenfield.
 Rev. Edwards A. Park, D. D., Professor at Andover.
 Hon. Joseph White LL. D., of Williamstown.
 Hon. Birdsey G. Northrop, LL. D., of New Haven.
 Hon. Edward B. Gillett, of Westfield.
 Hon. George W. Hubbard, of Northampton.
 A. Lyman Williston, Esq., of Northampton.
 Rev. Robert M. Woods, of Hatfield.
 Rev. William R. Huntington, D. D., of Worcester.
 Hon. Rodney Wallace of Fitchburg.
 Hon. George W. Hubbard, of Northampton, *Treasurer*.

NORTHAMPTON LUNATIC HOSPITAL.

Is located one mile west of the town, on the right bank of Mill river. The farm and grounds embrace about 340 acres. The construction of the building was commenced in March, 1856, and on the 15th of August, 1858, it was opened for the reception of patients. The building is four stories high, 190 feet deep, and a range of wings on each side three stories high, giving a front line of 512 feet. The floors cover an area of four acres. The first cost was \$315,000.

Trustees, Silas M. Smith, Esq., Northampton; Adams C. Deane, M. D., Greenfield; Henry W. Taft, Esq., Pittsfield; Lyman D. James, Esq., Williamsburg; Christopher C. Merritt, Springfield.

NORTHAMPTON DIKE

Commences at the southerly end of South street bridge and ends at the base of Fort hill; is 2,130 feet in length, and cost \$19,100. The following are the present officers of the Dike Company:

President, Roland Bartlett; *Collector and Treasurer*, Geo. D. Clark; *Clerk*, Henry S. Gere; *Directors*, L. B. Williams, O. S. Clark, Roland S. Bartlett, Joshua Knowlton, D. A. Rice; *Assessors*, Henry S. Gere, Joshua Knowlton, D. A. Rice.

FORBES LIBRARY.

Judge Charles E. Forbes, of this town, who died Feb. 13, 1881, bequeathed an estate valued at about \$300,000, to the inhabitants of the town of Northampton, to establish a Public Library. In May, the Legislature authorized the town to adopt and execute the provisions of the Will, and by a further act incorporated the library. George W. Hubbard and Oscar Edwards were made a corporation by the name of the "Trustees of the Forbes Library Fund," to hold office until their substitutes and successors are elected in the manner provided by the Will. At a special town meeting held May 31st, it was voted to accept the provisions of the Will; and it was

Voted Further, That the trustees under the Will of the late Charles E. Forbes, appointed by the Probate Court, are hereby directed to permit the whole sum of two hundred and twenty thousand dollars or upwards, which by the provisions of said Will is available for library purposes, to accumulate until the first day of January A. D. 1891, or for such shorter period as the Town by its vote shall at any future meeting limit and direct; to the end that whenever the said period of accumulation shall expire or be terminated, the income and accumulations from said sum may be divided into equal moieties, one moiety to be added to the Building Fund and the other to the Book Fund, as prescribed in said Will

In July, the Trustees purchased the Turner estate, on West Street, at a cost of \$20,000, as a site; \$5,000 of the purchase money was, however, donated by a citizen.

CLARKE INSTITUTION.

The Clarke Institution for Deaf Mutes was incorporated July 15, 1867, and John Clarke, of Northampton, donated \$50,000 for the establishment of the school, which was at once commenced, and the system of teaching articulation adopted. Miss Harriet B. Rogers was chosen Principal. On the 5th of July, 1869, John Clarke died, bequeathing to the Institution the bulk of his estate, which, with the donations made previous to his death, amounted to \$273,500, the income only of which can be used. In 1870, the trustees purchased the present site on Round Hill, and erected suitable buildings at a cost, including land and furnishing, of \$98,825. Additional buildings have since been erected to meet the increasing demands of the Institution.

Members of the Corporation, L. J. Dudley, Northampton, *Pres.*; Thos. Talbot, Billerica, *Vice-Pres.*; Julius H. Seelye, Amherst, *Vice-Pres.*; William P. Strickland, Northampton, *Clerk*; Gardiner G. Hubbard, Boston; William Allen, Northampton; Wm. P. Strickland, Northampton; Horatio G. Knight, Easthampton; William P. Strickland, Northampton, *Auditor*; Henry Watson, Northampton; Edward Hitchcock, M. D., Amherst; Lafayette Maltby, Northampton, *Treas.*; Harriet B. Rogers, *Principal*; Caroline A. Yale, *Associate Prin.*; Alice E. Worcester, *Special Teacher of Articulation*; Anna R. Leonard, *Assistant Teacher of Articulation*; Clara W. Lathrop.

Instructors, Ruth Witter, Katherine Fletcher, Mary A. Kathan, Fanny W. Gawith, Katherine H. Fish, Abby J. Gannett, Rebecca E. Sparrow, Fanny K. Young; *Steward,* Freeman C. Carver; *Matron,* Harriet O. Yale.

SMITH CHARITIES.

This Institution was founded by Oliver Smith, of Hatfield, who died Dec 22, 1845, leaving an estate valued at \$370,000. In his will, he directed that a board of trustees should be constituted in the following manner: The towns of Northampton, Hadley, Hatfield, Amherst and Williamsburg, in Hampshire county, and Deerfield, Greenfield and Whately, in Franklin county, shall choose at each annual meeting a person who shall be called an elector. The electors were to choose three persons who should constitute a board of trustees, who were to have the control and management of all the funds. He then set apart the sum of \$200,000, which was to be managed by the trustees as an accumulating fund, till it should amount to the sum of \$400,000. This accumulated fund was then to be divided into three distinct funds: One, of \$30,000, to found the "Smith Agricultural School," at Northampton; the second, of \$10,000, the income to be paid to the American Colonization Society, under certain restrictions. This society failing to comply with the terms of the Will, this fund was incorporated with the Agricultural fund. The third of \$360,000, for indigent boys, indigent female children, indigent young women and indigent widows. The remaining portion of his property was constituted a contingent fund, to defray expenses and keep the principal funds entire.

Since the Will went into effect, in October, 1848, to May 1, 1883, there has been paid to the people of the eight towns named, for

Taxes,	\$316,701.94
Annuities,	24,686.84
Indigent Female Children,	90,837.75
Indigent Boys,	176,500.00
Indigent Widows,	183,750.00
Indigent Young Women,	90,500.00
Total,	\$882,976.53.

The total amount of the several funds May 1, 1883, was \$1,110,-015.10.

PRESIDENT OF TRUSTEES.—Luther Bodman, Northampton.

TRUSTEES.—Luther Bodman, Northampton; F. G. Fessenden, Greenfield; Burr W. Banks, Haydenville.

Office Main, near First National Bank.

PRIVATE INSTITUTION.

Shady Lawn Mental and General Sanitarium.

GOTHIC



STREET.

Superintendent and Proprietor,

A. W. THOMPSON, A. B., (Harv. 1854);

M. D. and A. M., (Harv. 1857);

Ex-President Hampshire Medical Society, 1867.

In our first edition, we announced the opening and successful establishment of this elegant and now veteran institution, then two years old. In the second, and now again in this, we have the pleasure to chronicle its continuance, complete success, enlargement, improvement and interior and exterior decoration. Its career, initiated with enterprise and conservatively carried on, has been honorable and useful. And as we then congratulated its proprietor and the public upon its promise, we are glad to-day to find our auspication made good, and to renew our expressions to the latter and the former.

Shady Lawn has restored the boon of health to many sufferers, brought here from various quarters, some from great distances and some from our own State and the neighborhood; has contributed to the local industries and traffic of our community; and furnished employment and a home to its own officers of various grades.

A cottage with wide covered piazzas has been placed near Shady Lawn House; steam heat has been put in use, and the whole establishment made more and more in its appointments a well-equipped "medical home for invalids" of the private class; capable of satisfying the requirements of science, of comfort, and of luxury. Its patrons have been mainly from well-to-do circles; but economy can be consulted for its guests with equal attention to the medical indications of their treatment. Its present and its contemplated speedy further enlargement, will enable it to admit more than hitherto of patients to whom high fees would be an inconvenience.

In like manner, the practice of the house, while it derives its reputation from that specialty, is not confined to lunacy and nervous diseases, but equally includes those peculiar to women and chronic and surgical cases in general. It has appeared from results under its roof that the air of Northampton, even in hot weather, is, under good management, favorable to recovery from grave surgical operations, such as abdominal sections for example.

The throat and chest ailments of the seaboard and of bleaker localities are also well affected, according to the experience of Shady Lawn, by its soft, inland air, and its sheltered site.

As the years go by, this establishment, in addition to its long range patronage, has been favored with a growing increase of cases from the neighboring towns and counties, representing many forms of disease, both medical and surgical. It thus maintains its advanced position as a "Cottage Hospital," in which new departure—now held in great esteem—it was an early pioneer.

COURT RECORD.

SUPREME JUDICIAL COURT.

William Allen, Resident Judge.

Sittings, At Northampton, 3d Tuesday in April; Law Term, first Monday after second Tuesday in September; odd years in Greenfield.

SUPERIOR COURT.

Sittings, At Northampton; Civil Term, 3d Monday in February and October, and 1st Monday in June. Criminal Term, 2d Monday in June and 3d Monday in December.

DISTRICT COURT OF HAMPSHIRE CO.

William P. Strickland, Judge. Arthur G. Hamlin, Clerk.
Special Justices, A. J. Fargo, Easthampton, R. W. Lyman, Belchertown.

Sittings, At Northampton, Monday, Tuesday, Thursday and Saturday of each week. At Amherst, 1st and 3d Wednesday of each month. At Cummington, at option of Judge. At Belchertown, 1st and 3d Thursday of each month. At Huntington, 2d and 4th Thursday of each month. At Ware, 1st, 2d and 3d Fridays of each month. At Easthampton, 2d and 4th Saturdays of each month.

PROBATE COURT.

William G. Bassett, Judge. Joseph B. Parsons, Register.

Sittings, At Northampton, on the 1st Tuesday of every month. At Belchertown, on the 2d Tuesday of May and October. At Williamsburg, on the 3d Tuesday of May and October. At Amherst, on the 2d Tuesday of January, March, June, August and November.

COUNTY OFFICERS.

County Commissioners, E. A. Edwards, Southampton; Flavel Gaylord, Amherst; Elnathan Graves, Williamsburg. Meet at Northampton on the 1st Tuesday in March, September and December, and on the Tuesday next after 2d Monday in June.

Special Commissioners, Samuel L. Parsons, Northampton; Charles E. Blood, Ware.

Court Messenger, E. T. Hervey.

Notaries Public, John B. Bottum, C. N. Clark, John C. Hammond, F. N. Kneeland, E. Parsons, C. H. Pierce, T. G. Spaulding, Oliver Walker, Henry L. Edwards, Daniel W. Bond, W. H. Clapp, Horace K. Parsons, David Hill, Northampton.

Commissioners to qualify Civil Officers, H. H. Chilson, Wm. H. Clapp, Harvey Kirkland, Wm. P. Strickland, H. P. Billings, H. A. Longley, Elisha A. Edwards.

Medical Examiner, C. Seymour, M. D.

Jailor and Master of House of Correction, Henry A. Longley.

Judge of Probate and Insolvency, W. G. Bassett.

Clerk of the Courts, Wm. H. Clapp, Northampton.

Register of Probate, Joseph B. Parsons, Northampton.

Register of Deeds, H. P. Billings, Northampton.

County Treasurer, Lewis Warner, Northampton.

Sheriff, H. A. Longley, Northampton.

Deputy Sheriffs, Ansel Wright, H. M. Potter, Benson Munyan, Northampton; Thomas A. Orcutt, Florence; Jairus E. Clark, Easthampton.

Public Administrator, S. L. Parsons.

Master in Chancery, W. P. Strickland.

Commissioner of Insolvency, T. G. Spaulding.

Justices of the Peace, Daniel W. Bond, H. M. Abbott, H. P. Billings, H. H. Chilson, Wm. D. Clapp, E. C. Davis, Geo. B. Drury, Winthrop Delano, Pliny Earle, James Ellsworth, Henry P. Field, S. B. Fuller, Arthur G. Hamlin, John C. Hammond, Geo. W. Hubbard, H. R. Hinckley, Wm. B. Hale, J. M. Kellogg, Harvey Kirkland, Caleb Loud, Lafayette Maltby, Adolphe Menard, J. B. O'Donnell, Enos Parsons, H. K. Parsons, C. H. Pierce, Samuel L. Porter, Timothy G. Spaulding, Wm. P. Strickland, Oran Storer, J. A. Sullivan, E. P. Warner, Leeds, L. B. Williams, Geo. P. Warner, Oliver Walker, Lewis Warner, John Whittelsey, James L. Warriner, Arthur Watson, Charles E. Williams, John B. Bottum, S. D. Drury, Luther Bodman, Northampton.

STOCK COMPANIES.

ORGANIZED UNDER JOINT STOCK LAWS.

BELDING BROTHERS & CO.

Incorporated July 1st, 1882; Capital Stock, \$650,000. *President and Treasurer*, M. M. Belding, Brooklyn, N. Y.; *Vice-Pres.*, H. H. Belding, Chicago, Ill.; *Sec. and Asst. Treas.*, A. N. Belding, Rockville, Conn.; *Manager at Northampton Factory*, Edgar F. Crooks, 27 Hawley street.

CLEMENT MANUFACTURING CO.

Incorporated July 1882; Capital Stock, \$32,000. *Pres.*, Lewis Warner; *Treas.*, Wm. W. Lee. Cutlery Manfrs., Bay State.

CONN. RIVER LUMBER CO.

Incorporated 1878 ; Capital, ———. *Pres.*, Asa Smith, Hartford, Ct. ; *Sec. and Treas.*, T. W. Pearsall, New York. Manufacturers of lumber. Yards and office Mt. Tom.

CRYSTAL EMERY WHEEL CO.

Incorporated May 1st, 1880 ; Capital Stock, \$15,000. *Pres.*, J. Mulligan ; *Treas. and Manager*, Charles E. Stevens ; Hawley n Main.

DAMON NARROW FABRIC CO.

Incorporated Jan. 1, 1882 ; Capital, \$35,000. *Pres.* E. O. Damon ; *Treas.*, C. H. Pierce. Cotton tape manufacturers, Pleasant.

FLORENCE FURNITURE CO.

Incorporated 1873 ; Capital Stock, \$20,000. *Pres.*, A. T. Lilly ; *Treas. and Manager*, H. B. Haven ; *Supt.*, George C. Kellogg. Caskets and coffins ; Myrtle St., Florence.

FLORENCE MACHINE CO.

Incorporated 1877 ; Capital Stock, \$175,000. *Pres.*, Daniel G. Littlefield, Pawtucket, R. I. ; *Treas.*, Oscar N. Kyle ; *Manager*, S. L. Clark. Sewing Machines and oil stoves ; Main St., Florence.

FLORENCE MANUFACTURING CO.

Incorporated 1866 ; Capital \$100,000. *Pres.*, Daniel G. Littlefield, Pawtucket, R. I. ; *Treas.*, Frank N. Look ; *Supt.*, A. C. Estabrook. Manufacturers brushes and mirrors ; junc Nonotuck and Pine streets, Florence.

FLORENCE TACK CO.

Organized 1874 ; Capital Stock, \$30,000. *Pres.*, D. W. Bond ; *Agt.*, G. W. Bond ; *Clerk*, E. S. Bottum. Manufacturers tacks and nails ; Locust c Holyoke, Florence.

HAMPSHIRE MUTUAL FIRE INSURANCE CO.

Incorporated 1830. *Pres.*, Geo. W. Hubbard ; *Sec. and Treas.*, Oliver Walker.

GREENVILLE MANUFACTURING CO.

Incorporated 1846 ; Capital Stock, \$50,000. *Agent and Treas.*, A. Lyman Williston ; *Sec.*, F. H. Stoddard. Manufacturers cotton cloth ; junc Nonotuck and River Sts., Florence.

KNAPP DOVETAILING MACHINE CO.

Pres., S. M. Smith; *Treas.*, Wm. B. Hale. Factory at Florence.

MILL RIVER BUTTON CO.

Incorporated 1874; Capital \$90,000. *Pres.* H. G. Knight, Easthampton; *Treas.*, George P. Warner, Leeds; *Secretary*, W. B. Parker. Vegetable ivory button manufacturers, Main, Leeds

NONOTUCK POCKET BOOK CO.

Established 1875. *Supt.*, B. Lipshyt; *Treas.*, J. Holzman. Factory, 9 Pleasant.

NONOTUCK SILK CO.

Established 1838; Incorporated 1865; Capital Stock, \$360,000. *Pres.*, Ira Dimock, Hartford, Ct.; *Treas.*, Alfred T. Lilly; *Asst. Treas.*, A. G. Hill; *Supt.*, Samuel Porter. Silk manufacturers, Nonotuck street, Florence. Also at Leeds.

NORTHAMPTON CUTLERY CO.

Incorporated 1871; Capital Stock, \$100,000. *Pres.* H. R. Hinckley; *Treas and Supt.*, E. E. Wood. Cutlery manufrs, Bay State.

NORTHAMPTON GAS LIGHT CO.

Incorporated 1853; Capital Stock, \$100,000. *Pres.*, M. M. French; *Treas.*, Wm. B. Hale; *Supt.* D. W. Crafts. Office 105 Main.

NORTHAMPTON STREET RAILWAY.

Capital Stock, \$50,000. *Pres.*, Oscar Edwards; *Supt. and Treas.*, Edwin C. Clark; *Sec.*, Mark H. Spaulding. Office, Strong av, opp Conn R R R depot.

NORTHAMPTON EMERY WHEEL CO.

Incorporated May, 1879; Capital, \$100,000. *Pres.*, Ira Dimock, Hartford, Ct.; *Sec. and Treas.*, J. L. Otis. Manufactory and office, Leeds.

SMITH CHARITIES.

Incorporated April 10, 1849; Capital Stock, \$1,110,015.10. *Pres. of Trustees*, Luther Bodman, Northampton; *Trustees*, W. G. Fessenden, Greenfield, Mass., Burr W. Banks, Haydenville, Mass.; *Clerk*, Harry G. Townend; *Bookkeeper*, Geo. W. Clark. Office Main near King.

VALLEY FRUIT EVAPORATOR CO.

Pres., H. C. Haskell; *Sec and Treas.*, D. A. Horton. *General Manager*, E. Marsh. Office, R. R. Steam Mills, Main.

WILLIAMS MANUFACTURING CO.

Incorporated 1860; Capital Stock, \$100,000. *Pres.*, L. B. Williams; *Treas.*, H. F. Williams; *Supt.*, R. S. Bartlett. Basket manufacturers; office, foot Smith street.

POST OFFICES.

NORTHAMPTON POST OFFICE.

L. W. Joy, Postmaster.

Main Street.

OFFICE HOURS.—From April to October, 7 A. M. to 8.30 P. M. October to April, 7.30 A. M. to 3.30 P. M. Sundays, 10.00 to 10.30 A. M.

MAILS RECEIVED.

NORTH, Western Vermont and Canada, 9.30 A. M. From points West and North, via Conn. R. R. R., 12.15 and 5.30 P. M. From Points West and North, via N. H. & N. R. R., 11.30 A. M. and 6.15 P. M.

SOUTH, From Points via Conn. R. R. R., 9.30, 11.30 N. Y. papers, A. M., 1.15, 4.30 P. M. From Points via N. Y., N. H. & N. R. R., 7.15 A. M. and 1.15 and 7.15 P. M.

EAST, From Points via B. & A. R. R., 9.30 and 10.30 A. M., 1.15 and 8.15 P. M. From Points via B. & T. R. R., 8.15 and 9.30 A. M., 12.15 P. M.

WEST, From Points via B. & A. R. R., 7.15 A. M., 1.15 P. M. From Points via B. & T. R. R., 8.15 and 9.30 A. M., 12.15 P. M.

STAGE MAILS, Amherst, 10.00 A. M. North Hadley and Hadley, 10.00 A. M. and 4.00 P. M. West Farms, Loudville, Westhampton and Norwich, 10.30 A. M.

MAILS CLOSE.

NORTH, via Conn. R. R. R., 8.30 A. M., 3.40 P. M. Williamsburg Branch, 7.45 A. M., 12.30 and 8.15 P. M.

SOUTH, via Conn. R. R. R. (closed pouch to Springfield, 7.45 A. M.), 11.40 A. M., 4.50 P. M. Via N. H. & N. R. R., 10.50 A. M., 5.30 P. M.

EAST, via B. & A. R. R., East of Springfield, 9.50 and 11.40 A. M., 4.50 P. M. Via B. & T. R. R., East of Greenfield, 8.30 A. M., 3.40 and 8.15 P. M.

WEST, via B. & A. R. R., West of Springfield, 7.45 A. M., 5.30 P. M. Via B. & T. R. R., West of Greenfield, 8.30 A. M., 3.40 and 8.15 P. M. Via N. H. & N., West of Albany, 10.55 A. M. Via B. & T. R. R., including N. Y. City, Southern and Western States, 8.15 P. M.

STAGE MAILS, Amherst, 3.45 P. M. Hadley and North Hadley, 10.00 A. M., 3.45 P. M. West Farms, Loudville, Westhampton and Norwich, 2.00 P. M.

FLORENCE POST OFFICE.

H. F. Cutler, Postmaster.

ARRIVAL OF MAILS AT FLORENCE POST OFFICE.

FROM SOUTH, 10.20 A. M., 1.30 and 9.20 P. M.
FROM WILLIAMSBURG, 11.00 A. M., 5.30 P. M.

DEPARTURE OF MAILS.

SOUTH, 10.45 A. M., 5.30 P. M.

LEEDS POST OFFICE.

E. S. Ross, Postmaster.

MAILS OPEN.

7.00, 10.12, A. M., 1.18 and 7.13 P. M.

MAILS CLOSE.

10.40 A. M., and 5.20 P. M.

MT. TOM POST OFFICE.

Henry S. Wilder, Postmaster.

MAILS CLOSE.

NORTH, 8.38 A. M., 3.54 P. M. **SOUTH**, 12.02 and 5.21 P. M.

MAILS OPEN.

NORTH, 12.02 and 5.21 P. M. SOUTH, 8.38 A. M., 3 54 P. M.

LOUDVILLE POST OFFICE.

John Watson, Postmaster.

Mail closes 8.30 A. M. Opens at 3.30 P. M.

EASTHAMPTON

Streets and Avenues.

ADAMS, from junction of Cottage and Maple to Everett.
BALLARD, from Florence to Lyman.
BRIGGS, from Adams to Franklin.
BROOK, from junction of Hendrick and Plain running parallel with Broad Brook.
BURT, from Strong to Pomeroy at Holyoke line.
CENTER, from Main crossing Park, to Railroad.
CHAPEL, from Maple to junction of Holyoke and Clark.
CLAPP, from Forthill to Lovefield
CLARK LANE, from Oliver to Torrey.
CLIFFORD, from Adams past Gaston to end of survey.
CORNER LANE, from Southampton line, at the "Mines," to Westhampton line.
COTTAGE, from junction of Union and Payson Avenue, to junction of Holyoke and Clark.
DAVIS, from Adams opposite Liberty to end of survey.
DIVISION, from Hendrick, crossing Strong and Phelps to Line
DRURY LANE, from Loudville to Northampton line.
EAST, from junction of Ferry and Mountain, to Mt. Tom Station and Northampton line.
EMERALD PLACE, off Ferry near bridge.
EVERETT, from northerly terminus of Adams to end of survey.
FERRY, from junction of Pleasant and Lovefield, to junction of East and Mountain, at Alanson Clark's
FLORENCE, from junction of Manhan and Nonotuck to the Northampton line : Williamsburg road.
FORTHILL, from East crossing Manhan River to Northampton line
FRANKLIN, from Briggs to Clark
GASTON, from Maple crossing Briggs to Clifford.
GAUGH, from Holyoke to Pine.
GLENDALE, from Main crossing Manhan river to junction of West and Hannum.
GREENWOOD COURT, off Main below Cemetery.
HANNUM, from junction of Glendale and West to junc of Loudville and Torrey.
HARVEY PLACE, off Ferry, opposite Parsons.
HENDRICK, from Holyoke to Burt.
HIGH, from Prospect to Union.
HOLYOKE, from junction of Cottage and Clark to Northampton line, road to Holyoke.
JANES LANE from Parsons, passing East Cemetery to Mountain.
LIBERTY, from Union to Adams, opposite Davis.
LINE, from junction of South Park and Strong, following the Southampton line to the Southerly line of Easthampton.
LOUDVILLE, from junc of Hannum and Torrey to Mineral, at Loudville Village.
LOVEFIELD, from junction of Pleasant and Ferry, crossing Manhan river to Northampton line.
LYMAN, from Florence to Nonotuck.
MANHAN, from junction of Main and Pleasant, crossing Manhan river to junction of Florence and Nonotuck near North school house.
MAIN, from Manhan and Pleasant to South Main.
MAPLE, from junc of Cottage and Adams passing Franklin to end of survey.
MILL, from Manhan to the Gristmill.
MINERAL, from Southampton line, at the "mines," to Northampton line at Loudville.

MOUNTAIN, from junction of East and Ferry to Holyoke.
 NONOTUCK, from junction of Manhan and Florence to Northampton line,
 Northampton road.
 NORTH, from East, near Mount Tom Station, to Northampton line.
 OLIVER, from Park Hill to Northampton line.
 OX BOW, from River to Northampton line.
 PARK, from Main to junc of South and South Park.
 PARK HILL, from West to Northampton line.
 PARSONS, from Ferry, opposite Harvey Place, to Mountain.
 PAYSON AVENUE, Park to junction of Union and Cottage.
 PAYSON LANE, from Main to Park.
 PHELPS, from Strong, crossing Division to Line.
 PINE, from Cottage to Gaugh.
 PLAIN, from Hendrick, at junction of Brook, crossing Strong to Line
 PLEASANT, from junction of Main and Manhan, to junction of Lovefield and
 Ferry, near Williston Mills.
 POMEROY, from Burt, crossing Strong to Line
 PROSPECT, from Pleasant to High.
 RAILROAD, from Union to Payson Avenue.
 RIVER, from East crossing Manhan river to Forthill.
 SCHOOL, from Union to Center.
 SOUTH, from the junction of Park and South Park to junction of Main and
 South Main, thence to Glendale.
 SOUTH MAIN, from Main at intersection of South to Southampton line.
 SOUTH PARK, from junction of South and South Park to junction of Strong
 and Line, near Q. P. Lyman's.
 STONE PATH LANE, from junction of Holyoke and Clark to land of J. E. Clark.
 STRONG, from junction of South Park and Line to Holyoke line.
 SUMMER, from Pleasant to High.
 TORREY, from Southampton line at Glenwood Silk Mill to Northampton road.
 UNION, from Main to junction of Payson Avenue and Cottage.
 WATER LANE, from Water to Gaugh.
 WATER, from Holyoke to Water Lane.
 WEST, from Manhan to the Southampton line, at the bridge over North Branch.
 WILLISTON AVENUE, from junction of Union and Cottage to South end of
 Brookside Cemetery
 WRIGHT, from South Main to Glendale.

BLOCKS AND BUILDINGS.

Bank Building, Main opposite Williston Seminary.
 Bosworth's Block, Union near R. R. crossing.
 Chapman Block, 47 Main.
 Gould's Block, Union.
 Ionic Block, Main opp Union.
 Lambie's Block, 53 and 55 Main.
 Langdon's Block, School
 Mayher's Block, 57 and 59 Main.
 Merrill's Block, 23 to 31 Main.
 Putnam's Block, 41 to 43 Main.
 Union Block, 33 to 37 Main.
 Winslow's Block, 45 to 47 Main.

HALLS.

German Hall, Clark.
 Ionic Hall, Ionic Block, Main opp Union.
 Knights of Honor Hall, Lambie's Block, Main.
 Pomeroy Hall, 31 Main.
 Town Hall, Main opp Williston Seminary.

Easthampton Directory.

1883-4.

ABBREVIATIONS.

h, house ; c, corner ; bds, boards ; blk, block ; n, near ; opp, opposite ; ab, above ; res, residence ; r, rear ; bdg, building ; av, avenue ; adv, advertisement ; mfr, manufacturer ; dept, department ; p, page ; emp, employed ; mfg, manufacturing ; N, north ; S, south ; E, east ; W, west ; G E F Co., Glendale Elastic Fabrics Co. ; V M Co., Valley Machine Co. ; E R T Co., Easthampton Rubber Thread Co. ; N. Mfg Co., Nashawannuck Manufacturing Co ; W Mills, Williston Mills ; W & K Co., Williston & Knight Co. ; C R R Co., Connecticut River Lumber Co. ; C R R R, Connecticut River Railroad ; N H & N R R, New Haven and Northampton Railroad.

ABBOTT ALBERT E. paymaster Williston Mills, h S Main
Ackerman George, emp Webster & King, bds Torrey
Adams Annette Miss, h 8 Main
Adams Fred A., machinist at Holyoke, h 19 Pleasant
Adams G. King, night watchman W & K Co., h Manhan
Adkins Ebron J., engineer W Mills, h Pleasant
Adhing Paul, emp N Mfg Co., bds Clark
Ahearn John, laborer, h Glendale
Ahearn William, emp E R T Co., bds Payson
Alcorn Robert, emp N Mfg Co., bds Maple
Aldrich Lucia Mrs., rem to New York
Alexander Edward, bds Williston av
Alexander Mary N., widow Philip C., h Williston av
Allen Hiram B., sexton Main St. Cemetery, h Main
Alpress Maria T. Miss, h East, Mt. Tom
Alvord Edward S., jeweler and news depot, Chapman's blk, 49 Main, h Manhan
Alvord Susan A. Miss, h Manhan
Alvord Whitney F., livery Stable r Hill's Mansion House, h Manhan
American Express Co., Christian Kaplinger agt, Bank bdg, Main opp W Seminary

Anderson John A., emp Valley Machine Co., bds Payson
 Angevine Albro, rem to Northampton
 Angevine Munroe, gardener Mrs. S Williston, 12 Park, bds do
 Angevine Reuben, blacksmith, bds 3 Union n Liberty
 Arthur Edward, emp G E F Co., h Gaston
 Arthur John, emp Webster & King, bds Torrey
 Ashe Frank, mason, h Clifford
 Ashe Mary J. Miss (J. E. Lambie & Co.), bds Clifford
 Ashe Patrick J., law student, bds Clifford
 Atwater Elmore E., emp N Mfg Co., rooms 16 High
 Avery Charles N., farmer, h South Main
 Avery Cyrus H., hostler W. F. Alvord, bds Manhan
 Avery George H., whip lash and machine belting mfr, r 8 Pleasant, h
 do
 Avery Isaac, rem to Huntington, Mass
 Avery Lewis L., laborer, bds S Park
 Avery Lysander C., jobber, h Maple c Gaston
 Avery Sidney S., farmer, h S Main
 Avery William H., bds S Pleasant
 Axtel Doras S., rem to Westfield, Mass

BACON OWEN P., dyer, h N M Co. No. 2, Clifford
 Bacon William P. Rev., pastor 1st Cong Church, h 4 Manhan
 Baile Margaret, widow Michael, h Gaugh
 Baker George, h West n Manhan
 Baker Minnie, widow Lewis, h Clark
 Baker Rosa L., widow Seymour O., bds Manhan
 Baker Wealthy W., widow Charles, h 25 High
 Baldwin Albert N., rem to New York
 Baldwin's Boot and Shoe store, 33 Main
 Baldwin Lyman N., boot and shoe dealer, 33 Main, h 3 Prospect
 Ballou Susan, widow Alanson, h 17 High
 Bamforth Samuel, bds Railroad
 Bamforth Sarah M. Miss, dressmaker, h Railroad
 Bannister William, weaver G E F Co., h Everett
 Bardwell Jeremiah H., postmaster, h 3 Center
 Barnes h 11 Prospect
 Barnes Artemus, h 1 Prospect
 Barnes Frank D., clerk E. W. Wood, h 24 High
 Barnett Henry E. (Barnett & Leitch), bds Maple n Gaston
 Barnett John, farm hand, bds Hannum
 Barnett Mary, widow Joseph, h Clark c Franklin
 Barnett Robert, carpet weaver, off Liberty n Grist Mill, h Maple n
 Gaston
 Barnett & Leitch (Henry E Barnett and John Leitch, Jr.), carpet
 mfrs, Holcomb n C R R R
 Barrett William H., conductor C R R R, h Liberty
 Barron Emily E. Miss, book-keeper, h over E. R. Bosworth's office,
 Union
 Barron John, gardener, h Park
 Bartlett Newman W., farmer, h 63 Pleasant

Barton Augustus, rem to Northampton
 Barton Henry F., overseer Webster & King's silk mill, bds Torrey
 Bartosch Louis, emp G E F Co., h Maple
 Bassett Joel L., h West
 Bassett Joseph, butcher emp Merritt Loomis, h Manhan
 Bassett Justin H., h 6 Manhan
 Bassett William G., attorney-at-law, and judge Probate Court for
 Hampshire Co., office 74 Main, Northampton, h Park n Center
 Beals Dexter, farmer, h West
 Beals Dexter, Jr., laborer, bds West
 Beals Mary A., widow Leavitt, nurse, h Hannum
 Bedard Francis, rem to Northampton
 Begley Dennis, mason, h 16 Ferry
 Belding Clark, rem to Holyoke
 Belding Chloe, widow Frederick W., h West
 Belding Henry, farmer, h West
 Bement William F., milk peddler, h Florence
 Bemis George W. (Wetherbee & Bemis), h 16 High c Summer
 Benjamin Electa Mrs., h 17 Center
 Bennett Eugene, farm hand, bds East
 Beor Edward, rem to Swanton, Vt
 Beor Marshall, laborer, bds 61 Emerald Place
 Besmer Paul, emp Webster & King, bds Torrey
 Bifield Ann, widow Thomas, h Adams
 Birge Arthur L., rem to Northampton
 Birge Seetance, widow, rem to Northampton
 Bishop H. M. Mrs., dressmaker, 11 Main, h do
 Bishop Lizzie Mrs., bds Union n Liberty
 Bishop Phineas, farmer, h 11 Main
 Blakney Charles L., master mechanic W Mills, h Pleasant
 Blanchard Amos, carpenter, h Pine
 Blanchard John, farmer, h Hendrick
 Blanchfield Lawrence, emp W Mills, h Clapp
 Bly Laura P., widow Joseph W., h 45 Pleasant
 Bly Maria L., widow Hiram J., h 1 Union
 Bly William F., emp W & Knight, h 45 Pleasant
 Bolan Bridget, widow Michael, h Briggs
 Bomber Charles H., emp G E F Co., h Clark
BOSWORTH EDWIN R., carpenter, builder and lumber dealer,
 B Union n railroad crossing, h 2 Manhan. (See p 301.)
 Bosworth Frank, rem to Wyoming
 Bosworth Irving L., fireman C R R R, Mt. Tom div., h Liberty
 Bosworth Joseph B., farmer, h South Park
 Bouchar Telesphore, emp C R L Co., h East, Mt Tom
 Boudren Mary, widow Thomas, bds 17 Center
 Bovat Henry, emp W Mills, h 61 Emerald Place
 Bowlan James, rem to Hartford
 Boyden Walter L., teller First National Bank, bds High
 Boyle James, rem to Conn
 Boyle John, rem to Conn
 Bradley John, laborer, h Briggs

- Braman Roswell, h Cottage
 Braning Henry, h Clark
 Breckenridge William, emp V M Co., h 17 High
BRIERLEY H. D. & CO., dry and fancy goods, Gould's blk,
 Union. [See p 294.]
 Brierley Henry D. (H. D. Brierley & Co.), bds Pleasant
 Brierley John, overseer card room W Mills, h Pleasant
 Broderick David, farmer, h off Emerald
 Broderick David E., emp W Mills, h Ferry
 Broderick Ellen, widow Cornelius, h off Emerald
 Broderick Michael, farmer, h Parsons
 Brookside Cemetery, Williston av
 Brophy John T., foreman J. S. Smith's livery Stable, bds Union c
 Liberty.
 Brown Jane, widow James, h Maple
 Brown Joseph, emp W Mills, h 34 Emerald Place
 Brown Wilbur, farm hand, bds Mountain
 Brunnell Frank X, barber 41 Main, h 4 Union
 Bryant Anna Mrs., h 16 High
 Bryant Lewis C., emp W Mills, bds Pleasant
 Buckler Arthur, emp G E F Co., bds Payson
 Buckler Eli, weaver, h Cottage c Maple
 Buckler Thomas Mrs., h Prospect
 Buckley Eugene, laborer, h Holyoke
 Buckley Thomas, emp G E F Co., bds O. Flint, Liberty
 Buckner Clement, emp G E F Co., bds Maple
 Buckner George S., emp G E F Co., h Maple
 Buckner Gustinia, widow Clement, h Maple
 Buffum Charles A., Prof Languages W Seminary, h 3 Center
 Buffum Thomas, overseer finishing dept N Mfg Co., h South Main
 Buggee Robert, laborer, h Pine
 Buggee Robert B., emp E R T Co., h Cottage c Pine
 Burby Charles, helper emp Geo. L. Manchester, bds Water Lane
 Burby John, laborer, h Water Lane
 Burdick Mary, widow, nurse, h 18 Center
 Burket Annie J., widow Charles, Webster & King's boarding house,
 Torrey
 Burlingame George, farm hand, bds Hendrick
 Burnett Ellen, widow Mitchell, dressmaker 3 Pleasant, h do
 Burnett Margaret, widow John, h Cottage c Adams
 Burnham Eben, mason, h West
 Burt Charles W., emp H G Knight, bds Payson c Park
 Burt Jairus F., milk dealer, h Mountain
 Butler Jane Miss, h Pine
 Butler L. S. Miss, teacher, bds Pleasant
 Butler Margaret, widow Stephen, h Pine
 Butler Sarah E. Miss, teacher High School, rooms 20 Pleasant
 Butler Thomas, h 31 Emerald
 Butterworth Thomas, emp W Mills, h Everett
 Buzzee David H., overseer E R T Co., h Payson

CALLAHAN DENNIS, laborer, h Ferry
 Callahan Johanna, widow James, h Ferry
 Callahan Johanna, widow John, h Parsons
 Callahan Thomas, laborer, h Pine
 Cameron James, h Pleasant
 Cameron John, spinner W Mills, h 28 Ferry
 Campbell James, grocer and livery stable, Briggs c Gaston, h do
 Campbell Jane Miss, h Gaugh
 Campbell Lyman J., auctioneer, h South Main
 Campbell William, emp V M Co., h Briggs c Gaston
 Carney Mitchel, emp W Mills, h Ferry
 Carpenter Helen Mrs., bds Union c Liberty
 Carr Elizabeth, widow Mark, h Maple
 Carr Lydia W., widow Joseph R., bds East, Mt Tom
 Carr Robert G., emp N Mfg Co., h Maple
 Carrington Abbie A. Mrs., h West
 Cartledge Henry, emp G E F Co., h Everett
 Cartledge William, overseer of weaving narrow goods G E F Co., bds
 Adams c Briggs
 Cary Tristram, laborer, bds Cottage n Chapel
 Casey John D., canvasser, bds 35 Cottage
 Casey Margaret, widow Dennis, h 35 Cottage c Adams
 Cass Sarah Mrs., rem to Canada
 Caswell Charles H., overseer of braiding room G E F Co., h 6 Manhan
 Cavanaugh Julia Miss, h Everett
 Cavanaugh Thomas, laborer, h Parsons
 Cayo Joseph, laborer, bds Emerald Place
 Chamberlain Ellen, widow Albert, h Main
 Chamberlain Henry, student, bds Main
 Chapin Lysander, rem to New Hampshire
 Chapin Sarah E. Miss, principal High School, bds 13 Union
 Chapman Almon S., h 8 Center
 Chapman Amasa S., clerk Hill's Mansion House
 Chapman Charles M., emp N Mfg Co., bds 3 Prospect
 Chapman David L., peddler, h Hannum
 Chapman Edwin, teamster, h 18 Pleasant
 Chapman Electa M., widow Charles H., h 3 Prospect
 Chapman Hannah E. Miss, h 12 Union
 Chapman Jerome M., rem to Westhampton
 Chapman Polly Ann, widow Dr Solomon, bds 28 High
 Chase Andrew J., commercial agt, h 47 Pleasant
 Chase James, farm hand, h South Main
 Cherbonnou Ambrose, h 7 Ferry
 Church of the Immaculate Conception, Rev. R. F. Walsh, pastor,
 Adams
 Clair James, farm hand, bds S Main
 Clair Patrick, farmer, h Cottage
 Clapp Alice, widow I. K., rem to Monson, Mass
 Clapp Almira, widow Augustus, h Fort Hill c Clapp
 Clapp Amos B., farmer, h West
 Clapp Edward L., farmer, h Main n Center

- Clapp Harland, bds Olive c Clark's Lane
 Clapp Henry A., farmer, h Fort Hill c Clapp
 Clapp Henry, farmer, h River
 Clapp Helen Miss, emp N Mfg Co., bds 15 Center
 Clapp John A., farm hand, bds West
 Clapp John M., farmer, h West
 Clapp Laura, widow Solomon, h 1 Prospect
 Clapp Morris, farmer, h West
 Clapp William E., farmer, h S Main
 Clapp William N., farmer, h S Main
 Clark Alvin W., farmer, h Olive c Clark Lane
 Clark Anna C. Miss, dressmaker, bds 4 Union
 Clark Austin, farmer, h Mountain
 Clark C. K. Mrs., rem to Warren, Mass
 Clark Clara, widow Royal, h 45 Pleasant
 Clark Clarissa M., widow Edward, h East, Mt. Tom
 Clark Davis H., farmer, h South Park
 Clark Dwight L., W & K boarding houses, 3, 4, h Union
 Clark Edward H., farmer, h East
 Clark Edwin A., farmer, h Mountain
 Clark, Edwin S., emp N Mfg Co., h Williston av
 Clark Emma A., rem to Southampton
 Clark Frank, farmer, h Mountain
CLARK FRED L., teacher Piano, Organ and Harmony, bds 16
 Prospect. [See p 295.]
 Clark Fred N., farmer, bds Mountain
 Clark Fred W., poultry and eggs, h 16 Prospect
 Clark George W., farmer, bds Mountain
 Clark Henry, farmer, h Mountain
 Clark Horace, farmer, h Mountain
 Clark Horace L., sec W & Knight Co., h 4 Park
CLARK JAIRUS E., deputy sheriff for Hampshire and Hampden
 Counties, auctioneer and coal dealer, office N H & N depot, h 72
 Main. [See p 301.]
 Clark John M., farmer, h Olive
 Clark Laura P., widow Alanson, h Mountain
 Clark Lawrence D., bds East, Mt Tom
 Clark Lemuel, h 37 Union
 Clark Lewis L., farmer, h Florence
 Clark Lewis S., farmer, h Mountain
 Clark Louis A., student, bds Union n Liberty
 Clark Lysander L., farmer, h Olive
 Clark Marcia L., widow Abner L., h S Park
 Clark Mary A., widow Jason, h 4 Union
 Clark Mary E., widow Gilbert A., bds 12 Union
 Clark Milancie Miss, bds East, Mt Tom
 Clark Nettie D., teacher, bds Prospect, Park Hill
 Clark Obadiah, farmer, h Mountain
 Clark Oliver N., h 14 Center
 Clark Peter, rem to Conn
 Clark Sarah, widow Zenas, bds Mountain

Clark Thaddeus, farmer, h East, Mt Tom
 Clark Uriel, station agt Mt Tom, h East, Mt Tom
 Clark Z Brainard, farmer, h Mountain
 Clink Andrew, steel roller, h 45 Emerald Place
 Clink James M., shipper W Mills, h Pleasant
 Cobb Nathan A., teacher Williston Seminary, h Main c Payson Lane
 Coit Herbert J., coachman emp G R Williams, rooms 3 Union
 Cole Clara, widow Asa B., bds Pleasant
 Collins Dennis, h Pleasant
 Collins Robert, teamster N. Mfg Co., h Maple
 Colton Aaron M. Rev., h 15 Park
COLTON GEORGE S., overseer small wares dept G E F Co., also,
 mfr of Shoulder Braces, 59 Pleasant, h do. [See p 292.]
 Conley Thomas, h Water Lane
 Conn R R depot, Liberty c Union
 Connelly James, emp W Mills, h 60 Emerald
 Connelly Thomas, tinner, h Water Lane
 Conners Thomas, emp G E F Co., h Union
 Connery Anna Mrs., bds Gaugh
 Connery Patrick, laborer, h Holyoke c Water
 Connery Simon, laborer, h Holyoke
 Connery Simon 2d, emp E R T Co., bds Holyoke c Water
 Connery Simon W., emp E R T Co., bds Holyoke
 Connery Thomas F., painter, h Water Lane
 Connors see O'Connors
 Cooley Andrew J., painter, h West
 Cooley Zadoc S., h r D. W. Rust, Cottage
 Cooney Michael rem to Bridgeport
 Cooney Peter, farm hand, h Ballard
 Cooper Russell E., h Manhan c Mill
 Cooper Sophia, widow Sylvester, bds West
 Copson Thomas, rem to Hartford
 Corcoran John T., rem to California
 Corcoran Thomas, gas-fitter, emp G. L. Manchester, h Gaugh
 Cornish Philip, emp N M Co., h Maple n Adams
 Corry John, machinist W Mills, h Pleasant
 Cowan Mary, widow John, h Union
 Cowles E. Dwight, laborer, bds Union
 Coyle Bartley, mason, h Holyoke
 Coyle Bridget, widow Michael, h Adams
 Coyle John, night watchman N. Mfg Co., h Williston av
 Coyle Martin, brick layer, h Pleasant
 Coyle Michael, rem to St Cloud, Minn
 Coyle Michael H., mason bds Holyoke
 Crandall Seymour, farm hand, bds West
 Cripps Jane Mrs., h r 11 Summer
 Croake Patrick, mason, emp W. E. Topliff, h Pine
 Croake Patrick, Jr., hod carrier, emp W. E. Topliff, bds Pine
 Croake Thomas, hod carrier, emp W. E. Topliff, bds Pine
CROCKER C. A., treas Easthampton Paper Co., bds Hill's Man-
 sion House

Cullen John, carpenter, h Holyoke
 Cullen John, h Maple
 Culver Madison, blacksmith r 10 Pleasant, h 10 do
 Cummings Anthony, laborer, h Mountain
 Cummings Kate Miss, emp N Mfg Co., bds Pine
 Cummings Michael, emp V M Co., bds Pine
 Cunningham James, spinner W Mills, bds Pleasant
 Cunningham John W., rem to Hinsdale, Vt
 Cupson Thomas Mrs., emp N Mfg Co., h Cottage c Maple
 Curran Mary, widow William, bds Pleasant
 Cusick Mary Mrs., emp N M Co., h Cottage c Maple
 Cutting Anna C. Miss, teacher W Seminary, bds 89 Main

DADY EUNICE, widow, h 12 Summer
 Daigneault Louis E., emp F. X. Brunnel, bds 4 Union
 Dailey John, laborer, h Park
 Dailey John, emp A B Lyman, bds Park
 Dailey William, emp G E F Co., h Williston av
 Daley James, laborer, h 27 Emerald
 Daley Martin, carpenter, h Clifford
 Daley Maurice, emp G E F Co., h Everett
 Daley Peter, laborer, p Everett
 Daley Richard, laborer, h 34 Cottage
 Daley Richard, helper emp Geo. L. Manchester, h 29 Ferry
 Danks Warren, h 22 Pleasant
 David Alfred, painter, h Water
 David Thomas, painter, bds Water
 Davis Lewis, boarding house and feed stable, 36 Cottage, h do
 Davis Mary Mrs., widow, h Maple
 Deane E. B., bds Hill's Mansion House
 Deane Henry A., physician 29 High, h do
 Debarge John, rem to Chicopee
 Delaney Dennis, farm hand, bds Florence
 Delaney John, laborer, h Park
 Demont Jane Mrs., bds W M boarding house, Pleasant
 Demont William, emp W Mills, bds Payson
 Demond Charles M., rem to New York
 Densmore Eliza, widow David, h Stonepath Lane
 Dewar Robert, overseer weaving room N. Mfg Co., h 15 Center
 Diamond Charles T., emp W Mills, h Pleasant
 Diamond Edward P., emp W Mills, bds Pleasant
 Diamond Henry A., emp F P Newkirk, bds Pleasant
 Diamond John A., emp W Mills, bds Pleasant
 Diamond Patrick, h Pleasant
 Dibble Frank H., farm hand, bds S Main
 Dibble Louis N., shoulder brace mfr, 15 Summer, h do
 Dibble Lyman W., farmer, bds S Main
 Dibble Nelson O., farmer and shoulder brace mfr, h S Main
 Dibble Jane, widow Orland, rem to Granville, Conn
 Dinsmore David, clerk W. J. Sheehan, h Cottage, over Sheehan's
 store

Dist Court Room, Town Hall, Main
 Dodge Orlando H., overseer spinning room, No. 1 W Mills, h Pleasant
 Dodge Samuel, gen engineer W Mills, h Pleasant
 Donohue Michael, laborer, h 70 Emerald Place
 Dooley John, emp V M Co., bds 36 Cottage
 Dorsey Michael, h 15 Ferry
 Dower Laurence W., meat market, Cottage c Holyoke
 Doyle James emp W & K Co., bds Cottage n Chapel
 Doyle William, rem to New York
 Dresser Rufus C., farmer, h 18 Pleasant
 Driscoll Michael, rem to S Hadley
 Dunn Julia, widow James, h Ferry
 Dunn Martin Rev., asst pastor R C Church, h Adams
 Dwyer Daniel, shoemaker, h Pleasant
 Dwyer Daniel J., barber, bds 10 Ferry
 Dwyer Daniel J., laborer, bds 6 Ferry
 Dwyer Johanna, widow Edmund, h 10 Ferry
 Dwyer Michael, h Briggs
 Dwyer Patrick, emp W. Mills, h 10 Ferry
 Dwyer Patriek H., emp W Mills, h Pleasant

EAGAN PATRICK, emp G E F Co., h Adams c Briggs
 Eager Hermann, emp G E F Co., h Clark
 Easthampton Cornet Band, James Smith leader, Manhan Hall
 Easthampton Gas Co., works Liberty, n Conn R R depot
 Easthampton Live Stock Co., James O. Gale, manager, office First
 National Bank, Main

EASTHAMPTON NEWS, (weekly) Torrey Bros., publishers and
 proprietors, Ionic blk, Main. [See p 286.]

EASTHAMPTON PAPER CO., post office address Easthampton,
 mill at Loudville. [See p 292.]

Easthampton Post Office, Merrill's blk, Main

Easthampton Public Library, Park and Main

EASTHAMPTON RUBBER THREAD CO., Payson, near R R
 crossing. [See p 288.]

Easthampton Savings Bank, bank building, Main

Easthampton Social Orchestra, A. N. Baldwin leader, 47 Main

Eberg Solomon, emp N Mfg Co., h Clark c Chapel

Eger Eugene, emp G E F Co., bds Briggs

Eger Johanna, widow John D., h Adams

Ennis Ellen, rem to Northampton

Ennis Thomas, rem to Northampton

Erskine Nellie Miss, h W M boarding house, Pleasant

Erskine Robert, overseer twisting room, No 2 Mill, W Mills, h Pleasant

Evans Eliza, widow Thomas, h 6 Main

Ewing Crawford, farmer, bds Maple

Ewing Flora Miss, h over J. A. Loomis' store, Union

Ewing George W., farm hand, bds Torrey

Ewing James, farmer, h Torrey

Ewing James Jr., extract peddler, h Pine

Ewing John, laborer, emp E. W. Howland, h West n Manhan

Ewing Samuel, overseer spool room N Mfg Co., h Maple
Ewing Wm. L., traveling agent, bds Torrey

FADISCH CHARLES A., baker and restaurant, Union blk, 37 Main, h do
Fahey Nellie Miss, compositor News office, bds 4 School
Fahey Thomas, brick mason, h 4 School
Fairbanks Joseph W., principal Williston Seminary, h 89 Main
Fairchild Austin M., carpenter W Mills, h Pleasant
Fairservice Wm. A., spinner W Mills, h Pleasant
Fales John F., overseer N Mfg Co., h South Main
Fales Lyman G., mason, h 13 Center
Fargo A. J., lawyer and judge police court, office Winslow's blk, 47
Main, h Manhan above West
Farrell Felix, emp W Mills, h 61 Pleasant
Farrar Nathaniel W., clerk, emp C. J. Smith, h 9 Prospect
Fayhee Annie, widow John, h Everett

FAYHEE SAMUEL S., carriage mfr., r 10 Pleasant, h 21 Pleasant.
[See p 300.]

Fernald Cyrus E., Janitor W Sem., h 10 Main
Ferris John Mrs., h 18 Maple
Ferris Mary Mrs., h Clifford
Ferris Patrick, emp E R T Co., bds 18 Maple
Ferris Thomas, laborer, h Gaugh
Ferris William, dyer N Mfg Co., h Clifford
Ferris Willis, farmer, h Park
Ferry Abigail W., widow Sidney, bds Mountain
Ferry Charles E., farmer, h Mountain
Ferry Edward M., farmer, h East
Ferry Hiram, laborer, bds Florence
Ferry Louis T., emp S. S. Fayhee, bds South
Ferry Lucretia Miss, h 86 Main
Ferry Lydia A. Miss, h 86 Main

FERRY WALTER C., fish dealer 33 Main, h South. [See p 298.]

Fields Thomas R., porter Hill's Mansion House, bds do
Figgy William, emp Brick Yard, h Mountain
Finch Joseph F., carpenter N Mfg Co., h 98 Main
Finch Nelson M., emp N Mfg Co., h 17 Main
First National Bank of Easthampton, bank building, Main
Fisher Rosana, widow, bds Ballard
Fiske Fred H., clerk E. H. Howland, bds 7 Main
Fiske Lucy S. Miss, h 8 Main
Fitzgerald Patrick, carpenter, h 14 Ferry
Fleming Johanna Mrs., widow, laundress Hill's Mansion House, bds do
Fleming John, rem to Northampton
Fletcher George, emp C R L Co., h Ferry
Flint George, laborer, h Emerald Place
Flint Orville, boarding house G E F Co., 21 Liberty n C R R R depot
Flynn Mary, widow Patrick, h Park
Flynn Patrick, laborer, bds Park
Flynn Patrick, farmer, h Pleasant

Flynn William, laborer, bds South Park
 Ford Huldah B. Miss, clerk Rust, Wilson & Co., bds 11 High
 Ford Lewis T., overseer finishing room W & K Co., bds 11 High
 Ford Olive B., widow E. R., h 11 High
 Forrester Mary, widow Richard, h Lovefield
 Forsyth James, weaver G Mfg Co., h Briggs
 Forsyth John, weaver G E F Co., h Everett
 Fortin Joseph A., emp N Mfg Co., h Gaugh
 Frary Angeline, widow Noah, bds 11 Union
 Frary N. L., rem to Indiana
 Freitag Anna M., widow Gottfried, h 20 Liberty
 Freitag Louis, rem to Lemarsh, Iowa
 Friel Daniel, tin peddler, h Chapel
 Friel James H., carriage maker, emp Wm. J. Lyman, bds 36 Cottage
 Friel John, shoemaker, 37 Union, h Maple
 Frissell Rufus A., gardener Mrs. E. H. Sawyer, 21 Park, h Main

GABEL HENRY, emp N Mfg Co., h Clark n Franklin
 Galbraith John Rev., pastor M E Church, h 12 Prospect
 Gale Edward H., h Main opp Cemetery
 Gallagher Daniel, saloon Parsons, h Ferry
 Gallagher James H., rem to Holyoke
 Gallagher John, emp W Mills, bds 8 Ferry
 Garvey John, emp V M Co., h Maple
 Gates Sarah A. Miss, weaver N Mfg Co., h 39 Union
 Gates Wealthy Miss, h 39 Union
 Gaugh Frank G., emp Wm. J. Lyman bds Cottage n Pine
GAUGH FRED J., confectioner, stationer and auctioneer, 19
 Union, bds Maple n Franklin. [See p 296.]
 Gaugh Julia C. Miss, clerk C. L. Rust & Co., bds Cottage
 Gaylord Martin L., farmer and gardener, h West
 Gerard Frank Mrs., h Pine
 Gerard Frank, laborer, h Cottage
 Geraghty John, mule spinner, h Ferry
 German Hall, Clark
 Geselle John G., h Holyoke c Gaugh
 Gillan James, shipping clerk N Mfg. Co., bds Maple
 Gillian Mary Mrs., h Maple
 Gillespie James, mule spinner, W Mills, h 30 Ferry
 Gleason Betsy Mrs., widow, cook, bds 36 Cottage
 Gleason Cornelius, emp Valley Mach Co., h Adams
GLENDALE ELASTIC FABRICS CO., Union. [See p 289.]
 Gluns Fred, emp E R T Co., bds end Mill
 Gluns Rudolph, paper maker, h end Mill
 Goodell Elihu J., hostler G R Williams, rooms r 3 Union
 Goodenough Hubbard A., station agt C R R R, h 16 Prospect
 Goodman Stephen K., h 10 Center
 Gordon William, farmer, h Manhan
 Gorham Luther E., rem to Southampton
 Gorham William, emp Gas Works, h Liberty

Gough John, emp E R T Co., bds Payson
 Gouli Frank J., painter Lambie's blk, Main, h S Main
 Grany John, laborer, h 25 Ferry
 Graves Alonzo H., farmer, h Hendrick
 Graves Edward L., emp V M Co., h Glendale
 Graves Lewis W., clerk W & K Co., h 5 Union
 Graves Walstein, carpenter, h Glendale
 Greene Francis C., physician and surgeon 61 Main, h do
 Green Joseph W. Jr., treas and manager G E F Co., bds Hill's Man-
 sion House
 Green Peter H., boot and shoe maker 41 Main, h Manhan
 Greenough Adolphus, emp N H & N R R, h 66 Emerald
 Greenough Adolphus Jr., emp brick yard, bds 7 Ferry
 Greenough Alfred, laborer, h 50 Emerald
 Greenough David, h 37 Emerald
 Greenough Justin, laborer, h 44 Emerald Pl
 Greenough Lucy Miss, bds 37 Emerald
 Griesbaug Anton, emp E R T Co., h Maple
 Griffen Michael, emp N H & N R R, bds 8 Ferry
 Griffin James, emp W Mills, h 8 Ferry
 Griffin Lizzie Mrs., h Clark
 Grout Moses, rem to New London, Ct
 Gudhue Frank, rem to Chicopee, Mass
 Guerin Peter, laborer, h Ferry
 Guerney Mitchell, emp M. Rich, h 65 Emerald Pl
 Guerboak Anton, emp E R T Co., h Maple n Franklin
 Guernon G., rem to Warren, Mass
 Guernon James, laborer, h Cottage
 Guertin Zepheniah F., emp N Mfg Co., h Williston av
 Guillet Louis A., clerk Hill's Mansion House, rooms 51 Main
 Guillet L. A. Mrs., dressmaker 51 Main, h do
 Gulic Edward L., A. B., teacher mathematics and physics W Sem.,
 rooms 59 Middle Hall
 Gurney Emma Miss, emp W & K Co., h Union
 Guy Richard, emp office N Mfg Co., h Williston av

HAAS MICHAEL, h Mountain foot Clark
 Hale William B., pres First Nat'l Bank of Northampton, rem Spring-
 field, Mass
 Haley Joseph, emp E R T Co., bds 33 Cottage
 Haley John, painter, bds 33 Cottage
 Haley Michael, emp W Mills, h 36 Emerald
 Haley Stephen, foreman V M Co., h Pine
 Halford Henry, overseer rubber room G E F Co., h S Main
 Halford Samuel, watchman G E F Co., h Adams c Briggs
 Halford William, emp G E F Co., h Adams c Briggs
 Hall Ellen, widow Stephen, h 21 Union
 Hall Frank, rem to Westhampton
 Hall Harry G., brakeman C R R R Mt Tom Div., bds 21 Liberty
 Hampton Creamery Association, butter Mfrs, S Main c South

- Hand Alfred C., A. B., teacher elocution and physical education, W
 Sem, rooms 21 North Hall
 Hanlon Hugh, laborer, h Clark
 Hanlon Hugh Jr., rem to Chelsea
 Hanlon John, emp Pratt's bdg house, Payson, bds do
 Hannigan Mary Mrs., h Gaugh
 Hannigan Wm. N., emp E R T Co., h Union
 Hannum Edwin, farmer, h Hannum
 Hannum Edwin A., insurance agent, office 59 Main, h Hannum
 Hannum Eleazer W., farmer, h West
 Hannum Emily Mrs., n 13 Main
 Hannum Henry T., farmer, h West
 Hannum Jane F., widow Lucas W., h Manhan
 Hannum Hannah B., widow John M., h Hannum
 Harris A. B., pres Easthampton Paper Co., res Springfield
 Harris Darwin D., bds Payson av
 Harris Emma, widow Joseph A., h Payson
 Harvey John, spinner, W Mills, h 2 Harvey Place
 Hartwell Wilbur F., blacksmith, Mill, h Manhan
 Hathaway Dwight, emp W & K Co., h W K No 1 Union
 Hathaway George H., dry and fancy goods, 26 Pleasant, h do
 Haunton Horace, emp C Loud, h Loudville
 Hansdorf Benedigt N., silk picker W & K, h Torrey
 Hayes Joseph S. Mrs., h Adams c Cottage
 Haynes George G. emp V Mach Co., h r 9 Summer
 Haynes J. W., rem to Hartford
 Helpold Jacob, h Clark n Chapel
 Helpold Jacob Jr., emp N Mfg Co., h Clark
 Hendrick Charles, farmer, h Hendrick
 Hendrick Edward, farmer, bds Hendrick
 Hendrick Eldorus, farmer, h Hendrick
 Hendrick George W., R R contractor, h 20 Pleasant
 Hendrick Henry W., farmer, bds Hendrick
 Hendrick Joseph N., farmer, h Hendrick
 Hendrick Reuben S., farmer, h Hendrick
 Hendrick Theodore H., farmer, h Hendrick
 Hendricks James, farmer, h Strong n S Park
 Herney John rem to Holyoke
 Herney Thomas, h 9 Ferry
 Hetherington Wendall P., manager Hill's Mansion House, bds do
 Hickey Catherine, widow William, h Maple
 Hickey John, rem to Turners Falls
 Hickey John, rem to Northampton
 Hickey Joseph, rem to Northampton
 Hickey Martin, laborer, h Water
 Hickey Wm., moulder V M Co., h Water
 Hickey Wm., emp G E F Co., bds Maple
 Hill Annie E. Miss, teacher penmanship in Springfield, bds 31 High
 Hill David, (Hill & Wainwright), attorney-at-law Northampton, h
 11 Prospect
 Hill George A., overseer box room W & K Co., n 7 Prospect

- Hill Oscar F., bds 31 High
 Hill Oscar H., overseer packing W & K Co., h 31 High
 Hill Wm., prop Hill's Mansion House, opp the Park
HILL'S MANSION HOUSE, Wm. Hill prop, W. P. Hetherington, manager, Main opp the Park. [See p 30v.]
 Hillard Oscar, emp G E F Co., h Briggs
 Hillard Wm., emp G E F Co., h Adams
HILL & WAINWRIGHT, (David Hill, J. Arthur Wainwright), attorneys-at-law, 11 Prospect and Main, Northampton. [See p 243.]
 Hitchcock Fannie, widow Charles, h Holyoke
 Hoffman Gottlob J., inventor, h Briggs c Gaston
 Hoffman Frederick A., emp G E F Co., h Adams c Briggs
 Hoffman Henry, cigar manufacturer Holyoke, h do
 Hoffman John, emp G E F Co., h Holyoke c Water
 Hoffman Martin, emp G E F Co., bds Holyoke c Water
 Hogan Bridget, widow Patrick, h Clifford
 Holcomb Norman A., blacksmith off Liberty n Smith & Jordan's grist mill, bds Manhan
 Hollis Daniel, carpenter, h Holyoke
 Houghton Aldorus, rem to Northampton
 Howard A. Augustus, (J. A. Loomis & Co.), h 17 High
 Howard Amelia Miss, emp N Mfg Co., h 39 Union
 Howard Mary M., widow Cooley, h 15 High
 Howard Mary Miss, emp W & K Co., bds 21 Liberty
 Howland Edward H., florist 11 Main, h 7 do
 Huey George, rem to Southampton
 Huey John, farmer, h Cottage n Holyoke
 Huey Mary L. Miss, h Maple
 Hull Joseph Edward, baggage master N H & N R R, bds 7 Summer
 Hull Joseph W., farmer, h 7 Summer
 Hupfer Charles, h Briggs
 Hupfer Christian, h Pine
 Hupfer Frank, emp G E F Co., h Briggs
 Hupfer Hermann, emp G E F Co., and grocer, Adams c Clifford, h do
 Hupfer Louis, emp E R T Co, h Briggs
 Hupfer Oscar, bds Briggs
 Hutchins Greenleaf C., overseer W Mills, bds Pleasant
- IBERG SOLOMON**, overseer box room N Mfg Co., h School c Holyoke
- JACKSON JAMES**, h School
 Jackson John F., N Mfg Co., bds School
 Janes Catherine, widow Edwin, h S Main
 Janes Edwin S., farmer, traveling agent, h 49 Pleasant
 Janes Edwin E., express and jobbing, and coal dealer, yard off Liberty n Depot, h South Main
 Janes Franklin W., farmer, h Mountain
 Janes Louis S., teamster, h 49 Pleasant
 Jepson Dwight S., h 3 Union

Johnson Charles, carriage painter, bds Payson

JOHNSON CHARLES B., insurance and real estate agent, Bank building, Main, h 81 Main. [See p 295.]

Johnson Charles H., cashier First Nat'l Bank of Easthampton, bds 81 Main

Johnson Desire B. Miss, bds 81 Main

Johnson George M., cashier and book keeper G E F Co., bds Hill's Mansion House

Johnson Thomas M., h Briggs c Gaston

Jordan Lyman, (Smith & Jordan), h 26 High

Jordan Marcia Miss, weaver N Mfg Co., h 39 Union

Jordan Orsell Miss, emp G E F Co., bds 36 Cottage

Joy J. Addison, medical student, bds Olive

Joy Turner, farmer, h Olive

Judd Ellen M., widow Dwight B., h 71 Main

Judd Emerson B., blacksmith, School, h Wright

Judd Eva N. Miss, telegraph op N H & N R R depot, bds 71 Main

Judd John H., tinner, emp B P Owen, h 14 Prospect

Judd William A., (W. A. Judd & Son), h 63 Main

Judd William A. Jr., (W. A. Judd & Son), bds 63 Main

JUDD W. A. & SON., (Wm. A. Judd, Wm. A. Judd, Jr.), harness makers, boot and shoe makers, trunks, etc., Union blk, 35 Main. See p 296.]

KAEPEL ANNA M., widow John T., saloon Pine h do

Kaiser Wm. G., emp V Mach Co., h Clark

Kane William, emp G E F Co., h Park

Kaplinger Christian, grocer and agt Am and U S & C Express Co's, bank bdg, Main opp W Sem, h 13 Prospect

Kaplinger Cornelius M., driver Am Ex Co., bds 13 Prospect

Kearl Otto, rem to Louisville, Ky

Kearney Jane, widow Thomas, h Ferry

Kearney Michael, rem to New York

Kearns John A., tinner B. P. Owen, h 12 Center

Keaty John, h Stonepath Lane

Keeler Charles Mrs., h Clark

Keene James, fancy goods and confectionery, Union, n R R crossing, h do

Keep Robert P., Ph. D., instructor in Greek, W Sem, h Park c Center

Keith Frederick B., bds 12 Manhan

Keith Minerva, widow Frederick, h 12 Manhan

Keith Wm. D., h Manhan

Kellogg Mary Mrs., widow, rem to New York

Kelly Ambrose, emp Webster & King, bds Torrey

Kelly James, rem to Conn

Kelly Thomas, emp G E F Co., h Gaugh

Kencher Christiana, widow Geo. F., h Briggs

Kencher Geo. F., emp G E F Co., h Briggs

Kendrew Frank, dyer N Mfg Co., h Clifford

Kendrew Joseph, h Briggs

Kennedy Michael, gardener, emp Edward H. Howland, bds 7 Main

Kennedy Sarah Miss, chambermaid Hill's Mansion House
 Kern Mary Mrs., emp G E F Co., h Briggs
 Kerrigan James, engineer, emp N Mfg Co., h Chapel n Cottage
 Kerrigan Michael, laborer, h Glendale
 Kienle August J., emp G E F Co., bds Clark
 Kienle Fred, emp G E F Co., h Clark n Chapel
 Kienle Michael, emp G E F Co., h Briggs
 Kilbourn Horatio H., clerk J. A. Loomis & Co., h r 4 Union
 Kilbourn Lucy, widow Roswell A., h r 4 Union
 Kilmurray Martin, grocer, h Cottage c Chapel
 Kimball Frank H., carpenter, h 48 Pleasant
 Kimball Ida E. Miss, teacher, bds 48 Pleasant
 King Alonzo, (Webster & King,) bds Torrey
 King Elizabeth, widow Wm. D., h Torrey
 King Geo., emp M. Rich. bds Pleasant
 King Lucy, widow Marshall, h Pleasant
 King Peter, emp W Mills, h W M boarding house, Pleasant
 Kingsley Almeron A., carpenter, h 6 Main
 Kingsley George D., bds Hill's Mansion House
 Kingsley Rose Miss, music teacher, 4 Main
 Kinloch Alexander, h School
 Kinloch Isabelle L. Miss, h 46 Pleasant
 Kirby Edward, emp C R L Co., h Pleasant
 Kline Edward emp G E F, Co., h Adams
 Klinge Ferdinand, emp W Mills, h Pleasant
 Knight Horatio G., Pres and Treas W & K Co., and Pres E R T Co.,
 h Park c Payson
 Knight Munroe S., overseer covering room W & K Co., h 88 Main
 Knipfer Oscar W., emp Valley Mach Co., Co., h Briggs
 Knox James, engineer N Mfg Co., h Maple
 Knox Austin C., bds 77 Main
 Knox Charles E., bds 48 Emerald Pl
 Knox Thomas, emp N Mfg Co., bds Maple
 Knox John M., foreman F. P. Newkirk, h 77 Main
 Knowlton J. G., student, bds Summer
 Koehler L. T., emp G E F Co., h Stonepath Lane
 Koehler Richard F., emp G E F Co., h Stonepath Lane
 Koenig Emil C., supt shoe web dept G E F Co. and steamship agent,
 h Briggs c Gaston
 Kohler Henry emp V Mach Co., h Everett
 Kohler Henry, emp N Mfg Co., h Maple
 Kohler William, overseer weaving room N Mfg Co., h Clark
 Kopesky Anna widow Joseph, h over W. J. Sheehan's store, Cottage
 Kuhfuss Charles, emp G E F Co., h Clark
 Kuhn Morris G., emp G E F Co., h Adams
 Kyitek Charles, emp N Mfg Co., bds 17 Maple
 Kyitek Jacob, emp N Mfg Co., h 17 Maple

LACOMBE JOSEPH, farm hand, bds East Mt. Tom
 Lacrosse Lizzie, widow Peter, bds 71 Emerald Pl
 La Fleur Peter, painter, h 64 Emerald Place

- Lambie Jasper E., (J. E. Lambie & Co.), 53 Main
 Lambie Julius, farmer, h Holyoke
L AMBIE J. E. & CO., (Jasper E. Lambie, Miss Mary J. Ashe,
 Miss Maggie Mahoney,) dry goods, millinery, &c., 53 and 55 Main.
 [See p 294.]
 Lamprey Joseph, emp W Mills, h 71 Emerald Pl
 Langdon Chauncey W., h 19 Union
 Langdon Clarence H., laborer, h Ballard
 Langdon Elbert, farmer, h Florence
 Langdon Henry A., boot and shoe dealer, Gould's blk, Union, h 10 do
 Langel Louis M., rem to Holyoke
 Langel Matilda, widow, rem to Holyoke
 Lapan Alford, rem to St. Albans, Vt
 Lapan Nelson, rem to St. Albans, Vt
 Lapan Peter, rem to St. Albans, Vt,
 Larock Joseph, laborer, h Cottage
 La Rock Bridget, widow Peter, h 65 Emerald
 La Rock Peter, laborer, h 58 Emerald Pl
 Laru Alfreche, emp C R L Co, h East Mt. Tom
 Laroe Edward, emp G E F Co., bds 22 Pleasant
 Lavallee Albert, rem to Chicopee
 Lavallee Lafort, rem to Holyoke
 Lavin Daniel Mrs., emp N Mfg Co., h Cottage c Maple
 Lavin Margaret B., widow Daniel, h Maple
 Laviolette Joseph, shoemaker, emp H. A. Langdon, h Pleasant
 Lawler Ellen, widow Patrick, h Torrey
 Leach John, emp G E F Co., h Maple n Franklin
 Leary John, laborer, bds East
 Leehee Thomas, farm hand, h Ferry
 Lee Helen W., widow John, h 9 Prospect
 Lee William, laborer, h Pine
 Lefavour Henry, A. B., teacher arithmetic, grammar and history,
 rooms 9 South Hall
 Leitch John, emp G E F Co., h Adams
 Leitch John Jr., (Barnett & Leitch), bds Adams
 Leonard Charles S., carriage maker, Gaston n Maple, h Maple c Gaston
 Leonard Elizabeth L., widow Horatio, h 5 Union
 Leonard Granville H., mfg agt N Mfg Co., h Main opp Payson Lane
 Leverett Josiah S., h 2 Park
 Le Vetre Benjamin, mason, h Gaugh
 Levis Orril E., widow Paul, bds 8 Pleasant
 Liberty Jerry, emp N Mfg Co., h 11 Union
 Lloyd George, laborer, h 11 Center
 Lloyd J. Homer, emp W & K Co., h W K No 2½ Union
 Lloyd Willett H., emp W & K Co., h Liberty
 Lombard Estus, rem to Springfield
 Loomis Algernon M., h West n Manhan
 Loomis Joshua A., grocer and apothecary, Bosworth's block, Union,
 h 15 High
 Loomis Merritt J., meat market, Chapman blk, Main, h So Main c
 Wright

- Lonargan John C., shoemaker, 55 Emerald, h do
 Lonargan Wm. D., farm hand, rem to Westhampton
 Lounge George, emp G E F Co., h Adams c Briggs
 Luce Samantha, widow Reuben, h 13 Union
 Lucia Berkeley, teamster, h Everett c Davis
 Lucier Henry, laborer, h Maple
 Lucas Lisa, rem to South Adams
 Ludden Ardelia B., widow Almon B., h 5 Center
 Ludden Almon S., ice dealer, 6 Center, h do
L UDDEN ENOCH H., meat market 50 Pleasant, h do. [See
 L p 298.]
 Ludden Clara B. Miss, boarding house, 5 Center
 Lyman Alpheus J., grocer and dry goods, 77 Main, h Main
 Lyman Ansel B., farmer, h Main
 Lyman Austin J., farmer, bds S Main c South
 Lyman Dwight M., clerk A. J. Lyman, bds 73 Main
 Lyman Elisha W., farmer, h Florence
 Lyman Francis, farmer, h Ballard
 Lyman G. Burt, farmer, h Florence
 Lyman Henry L., farmer, h Park Hill
 Lyman Horace S., farmer, h Olive
 Lyman James H., farmer and Pres Hampton Creamery Asso, h South
 Main c South
 Lyman Jerome, tape mfr., Mt. Tom, h 15 Summer
 Lyman John N., emp G E F Co., bds Main
 Lyman Lemuel D., farmer, h Ballard
 Lyman Lorin D., farmer, h Park Hill
 Lyman Myron C., factory book-keeper N Mfg Co., h 32 High
 Lyman Quartus P., farmer, h S Park
 Lyman Samuel M., farmer, h West
 Lyman Samuel M. Jr., farmer, h West
 Lyman Sarah G. Miss, teacher, bds 71 Main
 Lyman Solon, farmer and milk peddler, h 6 Main
 Lyman Sophronia Mrs., bds East Mt. Tom
 Lyman Wm. J., carriage mfr, r 75 Main h 73 Main
 Lynn Bridget, widow James, h Lovefield
 Lynn James, farmer, h Lovefield
 Lynn Margaret Miss, grocery store Lovefield, h do
 Lyon Mary Miss, h 14 Center
 Lyons Mary, widow Patrick, bds Manhan

MADIGAN JOHANNAH S., widow William, h Mountain
 Maher Patrick, emp C R R R, h Maple
 Maher Pierce, laborer, h 63 Emerald Pl
 Mahoney James, emp C Loud, h Torrey
 Mahoney James, laborer, h Gaugh
 Mahoney John, carpenter, h Adams
 Mahoney Maggie Miss, (J. E. Lambie & Co.,) bds Gaugh
 Main Street Cemetery, Main Street
 Major Thomas, laborer, h Pine
 Mall Mrs. widow, rem to Leeds

- Malley Daniel, emp W Mills, h Cottage
 Maloney Jerry, emp E R T Co., h Payson
 Maloney John, rem to Northampton
 Maloney John W., emp W Mills, h 15 Ferry
 Maloney Michael, emp G E F Co., bds 36 Cottage
 Maloney William, farmer, h Lovefield
 Manchester George L., steam and gas fitter, supt Gas Co., Liberty, n
 C R R R Depot, h 8 Park c Center
 Mann Adelbert A., boot and shoe dealer, 75 Main, h do
 Mansfield B. P. Mrs., miller, 47 Main, bds Payson
 Mansfield B. Parsons, trader, bds Payson
 Mansfield Herbert L., clerk E. W. Wood, bds Payson
MANSION HOUSE, (Hill's) Wm. Hill propr, Main opp the Park.
M [See p 300.]
 Marble Alvah V., h Main
 Marble Eugene C., slater, h S Main
 Martin George, mason, bds West c Manhan
 Martin Larry, engineer W Mills, bds 21 Liberty
 Martin Lawrence engineer W Mills, h Emerald
 Martin Mary Miss, teacher intermediate school, bds East
 Martin Thomas, farmer, h Parsons
 Martin Willis B., farmer, h East
 Marvin Alice Miss, bds 36 Cottage
 Matthews Anna L. Miss, teacher, bds 16 High
 Matthews Horace, h 8 Main
 Matthews Martha Miss, bds S Main
 Matthews Mary, widow Southworth W., h 16 High
 Mattoon Lu Miss, teacher penmanship, bds 31 High
 Mayher John, treas and manager V Mach Co., h Park
 Mayher William, foreman foundry V Mach Co., h 71 Main
 McAlpine Robert A., jeweler, emp E. S. Alvord, bds 17 High
 McAuley Christopher L., clerk W. J. Sheehan, bds Adams c Briggs
 McAuley James, emp G E F Co., h Adams c Briggs
 McAuley John, emp G E F Co., h Adams c Clifford
 McAuley Peter, emp G E F Co., h Adams c Clifford
 McAuley Peter, emp E R T Co., h Briggs
McCANDLESS GEORGE H., dealer in millinery and faucy goods,
 also pianos and sewing machines, 5 Union, h do. [See p 295.]
 McCandless John, emp N M Co., h Maple c Gaston
 McCarty Dennis, laborer, h Gaugh
 McCarty John, emp E R T Co., h Adams
 McCarty Patrick, emp E R T Co., h Water
 McCauley John, emp G E F Co., h Clifford
 McCain Robert, h Holyoke
 McClennan James laborer, h Maple
 McCallum Elizabeth, widow Donald, yarn inspector W Mills, h
 Pleasant
 McCombs James, emp Webster & King, bds Torrey
 McConnell James, emp W Mills, h 13 Ferry
 McCune Patrick, stone cutter, bds Payson
 McDonald Edward, emp G E F Co., h Briggs

McDonough Catharine, widow Thomas, h Parsons
 McDonough John, emp W Mills, h Parsons
 McDonnell John, emp W Mills No 1, bds Parsons
 McEllert Michael, farm hand, bds S Main
 McGrath Michael, emp G E F Co., h Holyoke
 McIntyre George, h 15 Maple
 McKeirnan Hugh, clerk, bds Adams c Briggs
 McKeirnan James J., spinner W Mills, bds Briggs
 McKeirnan Jane, widow James, h Adams c Briggs
 McKennon James, helper, emp B. P. Owen, bds Union
 McKenney John, emp W Mills, h W M bdg house
 McKeraghan Samuel, emp N Mfg Co., h Main n Center
 McKerrigan Michael, farm hand, h Glendale
 McKinney Mrs. Terrance, h W M bdg house, Pleasant
 McKinnon James, tinner, emp Owen, bds Union n Liberty
 McKinnon Thomas, emp W Mills, h Ferry
 McKinnon William, emp W Mills h 67 Emerald
 McMahan James, overseer Japan room W & K Co., h Holyoke
 McMahan Mary Miss, photograph printer, emp W. P. Richardson, bds
 6 Summer
 McMahan William, emp G E F Co., bds Adams n Briggs
 McManamum Rosa, widow Dorvey, bds Williston av
 McMullen James, emp N Mfg Co., h Pine
 McNarama Daniel, rem to Canada
 McNeil Archibald, emp W Mills, h 33 Emerald
 McSorley Henry, emp N M Co., bds 19 Maple
 McSorley Janette, widow James, h Maple
 McVey Isabella, widow Edward, h Clifford c Gaston
 McVey John, emp V Mach Co., bds Clifford c Gaston
 McVey Patrick, emp V Mach Co., bds Clifford c Gaston
 Meaney Edward, emp N M Co., h Maple n Adams
 Meany James, emp V Mach Co., h Gaugh
 Meaney Margaret Miss, emp N Mfg Co., bds Maple
 Meehan Elizabeth, widow Roger, h Mill
 Meehan James, emp W Mills, bds 51 Emerald
 Meehan Joseph, bds Mill
MEIER GEORGE A., hair dresser and bath rooms, Merrill's blk,
 31 Main, bds Manhan. [See p 300.]
 Menton John, emp W Mills, h 42 Emerald
 Menton Mary widow Michael, h 47 Emerald
 Menton Michael J., mule spinner W Mills h 42 Emerald Pl
 Menton Patrick, emp W Mills, h 11 Ferry
 Menton Thomas, emp W Mills, h 47 Emerald
 Merkel Fritz, emp G E F Co., h Holyoke
 Merigan Lawrence, h Parsons
 Merriam Alexander R. Rev., pastor Payson Cong church, h Main n
 Union
 Merrick Jeffrey, emp W. Mills, bds 10 Ferry
 Merrick Patrick P., emp W Mills, h 10 Ferry
 Merrigan Lawrence, mule spinner, emp W Mills h Parsons
 Merrigan Patrick, laborer, h off Lovefield

Merrill Arthur R., emp W Mills, bds Pleasant
 Merrill John F., overseer spinning room No 2 mill W M, h Pleasant
 Mesack Thomas, emp E R T Co., h Maple
 Meserve George P., farmer, h Park Hill
 Meserve Henry G., farmer, bds Park Hill
 Messerschmidt Emil C., overseer finishing room G E F Co., h 20
 Liberty
 Messier John, emp V Mach Co., h Briggs
 Mieurhead Mrs. widow, h Pleasant
 Miller Alvah, h Payson av
 Miller Alvah Jr., bds Hill's Mansion House
 Miller D. C., Miss, librarian E H Pub Library Asso., bds 7 Main
 Miller Frank, tailor emp John A. Miller, bds Briggs
 Miller Frederick, painter, h Clark c Holyoke
 Miller John A., tailor Ionic blk, Main, h Briggs
 Miller Oscar W., emp N Mfg Co., bds Manhan
 Miller Wm. H., carpenter, h Manhan
 Mills Joseph W., emp C R L Co., h East, Mt. Tom
 Minahan Jerry, laborer, bds S Park
 Minor Adeline J., widow Elisha, h 1 Prospect
 Mitchell Perkins, rem to Hudson, N. Y.
 Mitchell Robert C., rem to New Britain
 Monahan Jerry, farm hand, bds South Park
 Monahan John, h Smiths Ferry
 Monahan William, farm hand, bds East, Mt Tom
 Moody George W., emp W & K, bds Torrey
 Mooney Patrick, laborer, h Water
 Moore John M., rem to Westfield
 Moore Nahum, farmer, h Pleasant
 Moran Dennis, night watchman E R T Co., h Manhan
 Moran Hannorah, widow Michael, h Gaugh
 Morey Edward, farm hand, bds Fort Hill c Clapp
 Morgan Marcy Miss, h Ferry
 Moriarty Thomas, dry goods peddler, h Holyoke
 Morrill Fred H., emp V Mach Co., h Williston av
MORRIS F. G., phonographer and teacher of short hand writing,
 h Payson Lane. [See p 295.]
 Morrisey Jerry, farm hand, bds Mountain
 Morrisey Patrick, laborer, h Parsons
 Morrison Frederick, emp N Mfg Co., bds Williston av
 Morrison James, livery stable, painter and paper hangings, Pleasant c
 Prospect, h do
 Morrison Lavina, widow John C., h Williston av
 Morrison Joseph F., emp N Mfg Co., h School
 Morrison Louis, laborer, h Clark n Franklin
 Morrison Maria, widow Patrick, h 15 Pleasant
 Morton Neal Miss, dressmaker 17 Main, h do
 Morton Nelly A. Miss, dressmaker, bds 21 Liberty
 Mowry Immer A., foreman George L. Manchester, h S Main
 Mulvey Thomas, laborer, h Parsons
 Munde Patrick, carpenter, h Gaugh

Munn George L., designer N Mfg Co., bds 16 High
 Munyan Alice M. Miss, teacher, bds 18 Center
 Munyan Emery, overseer ring room W & K Co., h W K 2½ Union
 Munyan Emily Miss, h 21 Union
 Munyan John W., truckman, Union, h 18 Center
 Murphy Edward, emp foundry, bds 57 Pleasant
 Murphy James, emp V Mach Co., h Pleasant
 Murphy John, emp W Mills, bds 57 Pleasant
 Murphy Michael, laborer, h 57 Pleasant
 Murphy Michael J., emp W Mills, h 1 Ferry
 Murray Frank, emp G E F Co., bds 36 Cottage
 Murray John, upholsterer, h Water Lane
 Murray Joseph, emp Wetherbee & Bemis, h 22 Pleasant

NADEAU FRANK, emp E R T Co., h Clark
 Naedel August, laborer, h Briggs
 Naedel Frank, emp G E F Co., bds Briggs
 Nagle Daniel, watchman W Mills bds Pleasant
 Nagle David, h Everett
 Nagel Patrick, teamster, emp W Mills, h Pleasant
 Nagle Richard, laborer, h Gaugh
 Nashawannuck Mfg Co., mfrs elastic webbing, suspenders, etc., Payson n Union
 Neidel Oswald, emp G E F Co., h Adams
 Nevins Augustus C., manager C R L Co., Holyoke, h Hannum
 New Haven & Northampton R R depot, Union n Liberty
 Neu Henry, barber, emp G. A. Meier, bds 21 Liberty
NEWKIRK FRANK P., stove dealer, plumber, hardware, agricultural tools, etc., Mayher's blk, 59 Main, h 9 Pleasant. [See p 297.]
 Newman George H., treas Nashawannuck Mfg Co., and W Mills h 91 Main
 Newton Albert S., h Manhan
 Newton Francis, laborer, h Clifford c Gaston
 Nichols Edwin J., trucking, h 22 Pleasant
 Niedringhaus Geo. W., rem to St. Louis, Mo
 Nolan James, rem to Holyoke, Mass
 Nugent John, emp E R T Co., bds 36 Cottage

OBEREMPT EWALD, emp G E F Co., h Holyoke
 Oberempt Hugo, book keeper N Mfg Co., h 9 Union
 Oberempt John H., emp E R T Co., h Payson
 O'Brien Edward, laborer, h Everett
 O'Brien Haunah Mrs., h Clifford
 O'Brien James H., bds Gaugh
 O'Brien John, laborer, emp W Sem, h Gaugh
 O'Brien Patrick, brick mason, h 3 Ferry
 O'Brien William, emp E R T Co., bds Everett
 O'Conner Daniel, laborer, h 48 Emerald Pl
 O'Donnell Daniel J., clerk W J Sheehan, bds 36 Cottage

O'Donnell Edward, clerk W. J. Sheehan, h Maple n Adams
 O'Donnell Robert, emp E R T Co., bds Payson
 O'Donnell Samuel, dyer N Mfg Co., h 19 Maple
 Oliver John, emp W & K Co., h Pine
 Oliver Robert, day watchman W & K Co., h Water Lane
 Oral George, laborer, bds Hendrick
 O'Rourke Charles, laborer, h Maple
 Ourda Joseph, h Holyoke
O WEN BYRON P., stove dealer and plumbing Union n R R crossing, h do. [See p 297.]

PADDOCK FRANK, student, rooms 88 Main
 Painter Edward, supt N Mfg Co., h S Park
 Painter Frederick, rem to Colorado
 Palmer Dora A. Miss, tailoress emp J. A. Miller, bds Manhan
 Parsons Charles J., farmer, h East. Mt. Tom
 Parsons Elisha, farmer, h East, Mt. Tom
 Parsons Eliza S. Miss, h Ferry
 Parsons Harriet, widow Levi, h 13 Union
 Parsons Henry A., farmer, h Union
 Parsons Joseph, farmer, h East, Mt Tom
 Parsons Lorenzo S., farmer, h East, Mt Tom
 Parsons Lucius E., farmer, h Ferry
 Parsons Lysander W., farmer, h East, Mt. Tom
 Parsons Mary, widow Miletus, h 11 Union
 Parsons Mary Miss, bds East, Mt. Tom
 Parsons Mary L. Miss, milliner 11 Union, h do
 Parsons Sarah, widow Thaddeus, h Ferry
 Parsons Sarah J. Miss, h Ferry
 Parsons Thaddeus, farmer, h East, Mt. Tom
 Patterson John Mrs., h 12 Summer
 Patterson Joseph, rem to Torrington, Ct
 Paul Basil, laborer, h Pine
 Payer Frank, laborer, h 34 Emerald Pl
 Payer Joel, laborer, h 38 Emerald
 Pearl Isaac E., A. B., rem to Boston
 Peltier John, emp W Mills, h 72 Emerald Pl
 Pendergast Thomas, teamster, h Gaugh
 Pepin Alphonse, emp N H & N R R, bds 20 Ferry
 Peppin Dominick, farmer, h Ferry
 Peppin Joseph, rem to Holyoke
 Peppin John, carpenter, h Ferry
 Peppin Louis, carpenter, bds Ferry
 Perkins Enoch C., miller, emp Smith & Jordan, bds 21 Liberty
 Perry John, emp C R L Co., h East c North, Mt. Tom
 Pertle James, rem to Chicopee Falls
 Pettis Austin L., farmer, h West
 Pippin Arthur, farm hand, bds East, Mt. Tom
 Piper Adolphe, emp G E F Co., h Adams c Clifford
 Plouff Thomas, emp W Mills, h 69 Emerald Pl
 Poist George, machinist, h East

Pollard James, farmer, h Manhan
 Pomeroy Alfred L., rem to Chicopee, Mass
 Pomeroy Calvin C., farmer, h S Main
 Pomeroy Edwin O., farmer, h Manhan c West
 Pomeroy Fannie Miss, teacher, bds S Main
 Pomeroy Frank H., carpenter, h 69 Main
 Pomeroy George, farm hand, bds East, Mt. Tom
 Pomeroy George H., dentist, bank building, Main, h 27 High
 Pomeroy Henry B., traveling agent M R B Co., h 26 High
 Pomeroy Henry F., (T. J. & H. F. Pomeroy), h 11 Summer
 Pomeroy Julius, farmer, h Florence opp Ballard
 Pomeroy Luther, shoemaker, h West
 Pomeroy Jenette, widow William W., nurse, h 16 High
 Pomeroy Theoren, farmer, and treasurer Hampton Creamery Asso, h
 Payson
 Pomeroy Thomas J., (T. J. & H. F. Pomeroy), h 17 Union
POMEROY T. J. & H. F., (Thomas J. and Henry F. Pomeroy),
 Undertakers and cabinet makers, 17 Main. [See p 299.]
 Pomeroy Wm. H., farm hand. bds East, Mt. Tom
 Pomeroy Wm. K., farmer, h West
 Porter Carrie W. Miss, clerk F. H. Putnam & Co., bds 53 Pleasant
 Powers Lawrence, rem to Northampton
 Powers Peter, mason, h 14 Maple
 Powers William, emp C R R, h Pleasant
 Powers Wm. S., emp W Mills, h 52 Emerald Pl
 Powers Willie H., farm hand, bds Fort Hill c Clapp
 Pratt Orinda Miss, rem to Hartford
 Pratt Roswell A., blacksmith, h Payson
 Prentice E. Miss, rooms over E. R. Bosworth's office, Union
PRESTON L. MONROE, clothier, merchant tailor, gents' fur-
 nishing goods, etc., 39 Main. [See p 294.]
 Preston Lucius, h 21 High
 Provost Emanuel, emp Seminary, h 59 Emerald
 Public Library Association of Easthampton, junc Main and Park
 Putnam Albert S., clerk F. H. Putnam & Co., bds 53 Pleasant
 Putnam F. H. & Co., book sellers, boots, shoes, sewing machines,
 pianos, organs, &c., 43 Main
 Putnam Francis H., (F. H. Putnam & Co.), h 53 Pleasant
 Putnam George W., clerk, emp F. H. Putnam & Co., bds 53 Pleasant

QUINLAN JAMES, emp N M Co., h Maple n Adams
 Quinlan Robert, N Mfg Co., h Cottage
 Quinlan Thomas, teamster, h Pine

RADELLI PEDRO, emp E R T Co., h Clark
 Ramsey Adam, laborer, h Pine
 Ramsey Robert, carpenter, h Briggs
 Ranney Nathan H., fish and oysters, 61 Pleasant, h do
 Reece James, emp W K & Co., h Liberty
 Reed Etta R., widow William, h 69 Main

- Reed Jane, widow John, h 16 Maple
 Regan John, laundry, West, h do
 Reid John K., engineer and watchman G E F Co., h Cottage n Chapel
 Remington Sarah M., widow George, bds 1 Union
RICE HENRY C., mfr Rice's Patent Calf Weaner, 2 Union, h do.
 [See p 302.]
 Rice Henry S., clerk, bds Union c High
 Rich George M., emp Martin Rich, bds Mountain foot Clark
RICH MARTIN, brick mfr and saw mill, Clark n Mountain, h
 Mountain foot Clark. [See p 292.]
 Richardson William P., photographer, Winslow's block, 47 Main, h
 Prospect
 Richmond Wm. H., harness maker, emp W. L. Richmond, bds 22, High
 Richmond William L., harness maker, 7 Union, h 22 High c Summer
 Riddel Alvin, emp G E F Co., h 20 Liberty
 Robinson George, rem to Holyoke
 Robinson Erwin, painter, h 7 Center
 Rockey Charles, emp G E F Co., h Adams c Clifford
 Rodimon Enoch D., conductor Conn R R R, bds 21 Liberty
 Roehrig Louis J. H., emp G E F Co., h Adams
 Rohan Bridget, widow Thomas, h r 22 Pleasant
 Rohan James, rem to Holyoke
 Rohan Patrick, hostler J. S. Smith, bds Union c Liberty
 Rollason Nathaniel, rem to England
 Root Albert R., carpenter, h Manhan c Mill
 Rosbrook Francis O., engineer, h Manhan
 Rose Sarah Mrs., h 8 Ferry
 Rose Sarah A. Miss, bds 8 Ferry
 Rossiter John, A. B. rem to Windsor, Conn
 Rowan Joseph, h 26 Cottage
 Rowe Mary, widow Michael, h Pine
 Rudd Ellen J. and Laura A., Mrs., rooms over E. R. Bosworth's office,
 Union
 Ruel Joseph, farm hand, h 62 Emerald Pl
 Rush James, emp G E F Co., bds 36 Cottage
 Russell Isaac H., resident agent Williston Mills, h Pleasant
 Rust Charles S. (Rust, Wilson & Co.), h 17 Pleasant c Prospect
 Rust Daniel Mrs., widow, h Park
 Rust D. Warner, overseer E R T Co., h Cottage
 Rust George, clerk Rust, Wilson & Co., bds lower Park
 Rust Pliny, h Manhan
 Rust Wm. B., stitcher N Mfg Co., bds Manhan
RUST, WILSON & CO., (Charles S. Rust, Joseph W. Wilson),
 dry goods, carpets, clothing, millinery, &c., Merrill's block, 27
 and 29 Main. [See p 293.]
 Ryan Daniel, emp W Mills, bds 35 Emerald
 Ryan James, emp V Mach Co., h Clark
 Ryan John, emp W Mills, bds Parsons
 Ryan Michael, laborer, h Parsons
 Ryan Michael Jr., bds Parsons
 Ryan Michael Mrs., h Water Lane

- SABISH HERMANN, emp G E F Co., h Cottage c Maple
 Salmon Maurice, emp M Rich, h Mountain
 Sammons John, laborer, h Cottage c Pine
 Sampson Henry J., farmer, h Hannum
 Sampson Mary A., widow Hilen K, housekeeper, bds Hannum
 Sanders Albert D., treas Easthampton Live Stock Co., h 79 Main
 Sawyer Edmund H. Mrs., h 21 Park
 Sawyer Edmund H., student, bds 21 Park
 Sawyer E. Thomas, treasurer and general agent Easthampton Rubber
 Thread Co., h Main
 Sawyer Henry H., rem to New Mexico
 Sawyer Joseph H., Prof. mental science and English literature, h 83
 Main
 Scannell Michael, farmer, h Lovefield
 Scheicker Barbara, widow John, h Clark c Holyoke
 Scheicker John, emp G E F Co., bds Holyoke c Water
 Schieker Paul, tailor, Gaston, h do
 Schlicher Frederick, emp N Mfg Co., h Maple
 Schloaipitz Ferdinand, emp Webster & King, h Torrey
 Schmidt Alfred, weaver Webster & King, bds Torrey
 Schofield John H. Rev., h 1 Glendale av
 Schreiner Max, emp M Rich, bds Payson
 Schroeder Christian, laborer, h 26 Ferry
 Schwam Ferdinand, laborer, h Clark
 Scollay David, teamster, h Gaugh c Water Lane
 Scott Francis, emp G E F Co., h 32 Cottage
 Scott Francis, laborer, h Cottage
 Scott L. Maria, Jennie A. and Lizzie A., Misses, dressmakers, h 63
 Main
 Scott Walter J., painter, h 63 Main
 Scully Wm. J., rem to Northampton
 Searle Fannie, widow Sheldon, h West
 Searle George, painter, h West
 Searle Jared P., farmer, h Park
 Searle Lydia E. Mrs., h 10 Summer
 Searle Mary E., widow Henry C., h Park
 Searle Rosa E. Miss, teacher, bds 10 Summer
 Searles Frank, farmer, bds Holyoke
 Searles Luther B., farmer, h Holyoke
 Seaver Jay W., A. B., rem to New Haven, Conn
 Seelye Samuel T., pres First Nat'l Bank of Easthampton, and treas
 Easthampton Savings Bank, h Park
 Seegee Henry B., emp F. P. Newkirk, bds 9 Pleasant
 Sexton James, h 70 Pleasant
 Seymour Charles, farmer, h Manhan
 Shandrew Hiram Mrs., h Center
 Shandrew Harriet B., widow John, h 16 Center
 Shandrew Wm. N., rem to St. Paul, Minn
 Shaw Alfred S., yardman, emp W Mills, h Pleasant
 Shaw Fred C., farmer, h West
 Shaw Henry D., clerk J. A. Loomis & Co., bds Union n Liberty

- Shea James, emp W Mills, bds 5 Ferry
 Shea John J., emp W Mills, h 40 Emerald
 Shea Matthew, emp E R T Co., bds Holyoke c Water
 Shea Michael, emp W Mills, h 5 Ferry
 Shea Sarah, widow Patrick, h Gaugh
 Shearn Austin, farmer, h S Main
 Sheehan Catherine Mrs., h Holyoke
 Sheehan Cornelius J., laborer, bds Water
 Sheehan Edward, laborer, h 33 Cottage
 Sheehan Edward J., clerk W. J. Sheehan, h Holyoke c Gaugh
 Sheehan John, emp E R T Co., h Maple
 Sheehan John F., clerk L. W. Dower, h Cottage
 Sheehan Timothy, laborer, h Water
SHEEHAN WILLIAM J., grocer, Cottage, h Holyoke. [See p 299.]
 Sheldon Herbert, emp N H & N R R, bds 21 Liberty
 Sheridan Timothy, laborer, h Park
 Shoals George H., h 4 Center
 Shoals Horatio B., carpenter, h Mill
 Shoals Maria M., widow George P., h 4 Center
 Shumway Van Ness C., clerk J. A. Loomis, h 13 Main
 Slattery James, laborer, h Everett
 Slattery John, rem to Northampton
 Slattery Julia Miss, housekeeper, bds 11 Summer
 Slattery Michael, laborer, h Gaugh
 Slattery Michael B., emp V Mach Co., h Everett c Davis
 Slattery Timothy, farmer, h 72 Pleasant
 Slattery Timothy J., meat peddler, emp Wetherbee & Bemis, h 72 Pleasant
 Smith Archibald, overseer, of shoe web weaving dept G E F Co, h 19 Briggs c Gaston
 Smith Bennie S., student, bds 1 Union
SMITH CHARLES J., druggist, Winslow's blk, 45 Main, h 25 High. [See p 296,]
 Smith Charles W., farmer, h Manhan
 Smith Deborah Miss, rem
 Smith Earle D., carpenter, h Holyoke
 Smith Edward, machinist, bds 17 High
 Smith Emily H., widow John R., h 5 Union
 Smith George H., emp W K & Co., bds Union c Liberty
 Smith Isabella Mrs., h Maple c Adams
 Smith Jabez S., livery stable, r 21 Union, and overseer covering room W & K Co., h Union c Liberty
 Smith James, dyer, h 40 Center
 Smith James A., (Smith & Jordan), bds 21 Liberty
 Smith James H., book keeper Rust, Wilson & Co., h 7 Main
 Smith John R., emp N Mfg Co., bds Maple c Adams
 Smith John T., overseer G E F Co., bds 21 Liberty
 Smith Laban Mrs., rem to Thompsonville, Conn
 Smith Laura C., widow David, h 8 Prospect
 Smith L. M., widow David, rem to Minneapolis, Minn

- Smith Lucy S. Miss, teacher High school, bds 8 Prospect
 Smith Margaret, widow James, h Maple
 Smith Minerva Miss, bds Manhan
 Smith Mort H., rem to New York
 Smith Paulina, widow John, h r Maple
 Smith Robert M., silk dyer Webster & King, bds Torrey
 Smith Samuel, dyer N Mfg Co., bds Williston av
 Smith William, emp G E F Co., h Center
 Smith Wm. L., rem to Hadley, Mass
 Smith Wm. M., emp G E F Co., h 11 Briggs c Gaston
 Smith Wm. O., day watchman N Mfg Co., h Maple
SMITH & JORDAN, (James A. Smith, Lyman F. Jordan), mil-
 lers, flour, grain, off Liberty, n Conn River depot. [See p 299.]
 Snow Lewis S. barber, emp Geo. A. Meier, h 22 Pleasant
 Spear David C., carpenter and builder, off Liberty n grist mill, h 1
 Prospect
 Spencer Melvin, laborer, rem to Northampton
 Spooner Aaron T., emp N Mfg Co., h 9 Summer
 Spooner Florence Miss, teacher, bds Glendale
 Spooner Wm. E., carpenter, h Glendale
 Staab Jacob, rem to Northampton
 Staab John O., farmer, h Park Hill
 Stacy Susie N Miss, emp L. N. Dibble, bds 15 Summer
 St. Clair Bruno, emp M Rich, h 46 Emerald Pl
 Stephens Esther A. Miss, dressmaker 6 Union, bds do
 Stephens Margaret, widow Geo. h 6 Union
 Stevenson Ansel, emp V Mach Co., h Adams
 Stevenson George, emp G E F Co., bds Pleasant
 Stewkhuller August, dyer Webster & King, bds Torrey
STIMPSON J. B., concrete and asphalt paver, office Frank P.
 Newkirk's, 59 Main, home office Newton, Mass. [See p 281.]
 Strangford Alexander, carpenter, h Water
 Strangford Andrew, machinist V Mach Co., h 19 Pleasant
 Strangford David, overseer rubber room N Mfg Co., h Maple
 Strangford John, tin peddler, h Maple
 Strangford Martha Miss, h Maple
 Strangford Thomas, emp G E F Co., h Clark c Franklin
 Stratton John S., milk peddler, h Florence
 Street Sarah W. Mrs., h Main c Payson Lane
 Street Willoughby W., jeweler, 43 Main, h 3 Summer
 Strong Arthur, rem to Holyoke
 Strong Calvin L., farmer, h Strong
 Strong Calvin S., farmer, h Strong
 Strong David L., farmer, h Holyoke
 Strong Delia A., widow Henry C., h 21 Union
 Strong Harriet, widow Benjamin, bds Strong
 Strong James W., carpenter, h Mill
 Strong John L., clerk E. W. Wood, bds Mill
 Strong Marshal D., mail carrier, h Holyoke
 Strong Martha A. Miss, teacher, bds Payson
 Strong Plympton, rem to New Haven

Sugrue John P., hostler W. E. Alvord, rooms do
 Sullivan Mortimer E., clerk L. W. Dower, bds Holyoke
 Sutherland James Mrs., h over H. A Langdon's store, Union
 Sutherland Wm. J., rem to New York

TAFT GEORGE W., mason, bds 12 Union
 Taintor Myron F., watch repairer, emp E. S. Alvord, bds 14 High
 Tapley Mary A., widow Charles, h Pleasant c Summer
 Tatro Fred, farm hand, h 22 Ferry
 Tatro Joseph, emp C R R R, h 15 Ferry
 Tatro Lizzie, widow Joseph, h 15 Ferry
 Taylor William, emp G E F Co., h Adams
 Taylor Wm. G., carpenter. h 4 Summer
 Telbo Peter, rem to St. Albans, Vt
 Tencellent Thomas, emp N Mfg Co., h Maple
 Thayer Sarah Mrs., h Williston av
 Thayer Ed, rem to Northampton
 Thayer Geo. A., farmer, bds S Main
 Thayer, Jos. T., grist mill, flour and grain, foot Mill, h 24 Pleasant
 Thayer Zabdiel A., farmer, h S. Main
 Thayer Myron W., miller, emp J. T. Thayer, h Prospect
 Thew Kate L. Miss, clerk C. A. Fadisch rooms, Pleasant c Prospect
 Thompson Esther Miss, bds Manhan
 Thompson Jane Miss, h East, Mt. Tom
 Thompson John P., agent C R L Ca., rem to Northampton
 Thompson John S., h Clark
 Thompson Moses L., rem to Bridgeport
 Thurston Kirk J., book keeper F. P. Newkirk, bds 3 Union
 Tibbitts Charles, laborer, h 8 Manhan
 Tibbitts James, painter, h 11 Union
 Tolman John W., clerk E. W. Wood, h over the store
 Toogood Lyman O., painter, h 5 Prospect
TOPLIFF WILLIAM E., mason, h 90 Main. [See p 302.]

TORREY BROS., (Lewis E. Torrey, D. Clarence Torrey), props
 Easthampton News and Enterprise, book and job printers, Ionic
 blk, Main. [See p 286.]
 Torrey D. Clarence, (Torrey Bros.), bds 50 Pleasant
 Torrey Esther M. Miss, teacher, bds Torrey
 Torrey Inez Miss, compositor Torrey Bros., bds Torrey
 Torrey Jason E., farmer, h Torrey
 Torrey J. E. Mrs., carpet weaver, h Torrey
 Torrey Lewis E., (Torrey Bros.), h 50 Pleasant
 Town Clerk's office, 27 Main
 Town Hall, opp Williston Seminary, Main
 Totman Albert F., pattern-maker V Mach shop, h 9 Summer
 Tredo Eli, emp brick yard, h 2 Ferry
 Truhart Henry, laborer, h Pine
 Truhart John, emp W Mills, h 49 Emerald

UEBEL EHARDT, emp G E F Co., bds 21 Liberty
 Uebel Charles, foreman spooling department G E F Co., h Holyoke
 Uebel Gustave, rem to New York
 Uebel Reinhardt, emp G E F Co., h Briggs
 Ultsch Elizabeth, widow Peter, h Briggs c Gaston
 Underwood Richard F., farmer, h East, Mt. Tom
 United States & Canada Express, C. Kaplinger, agt, Bank blk, Main
 Upson Charles, emp E. R. Bosworth, h Cottage c Holyoke
 Upson Justus, h Cottage c Holyoke

VAIL BRIDGET, widow John, h Holyoke
 Vaillette Edward, h Torrey
 Valley Mach Co., mfrs steam pumps, Payson
 Viax Marius, laborer, bds Emerald Pl
 Vickus Andrew, cook Hill's Mansion House, h r 27 High
 Vickus Charles H., hostler, emp W. F. Alvord, h r 27 High
 Vickus Frank J., laborer, bds r 27 High
 Voegler Louis, emp G E F Co., h Briggs
 Voigt Charles, farmer, h Holyoke
 Voigt Bernard, emp G E F Co., h Adams
 Voigt Rudolph, emp G E F Co., h Maple c Franklin
 VomFloten Julia and Charlotte Misses, h Cottage n Pine

WABNITZ CARL G., overseer weaving room N Mfg Co., h Adams
 Wade Lewis C., carriage maker, School, h South Park
 Wade Thomas, rem to Leeds
 Wade William, laborer, h 4 Ferry
 Wade William Jr., spinner W Mills, h Ferry
 Wadsworth Harriet Miss, bds W K 4 Union
 Wagner John M., cigar mfr, h Clark c Holyoke
 Wainwright J. Arthur, (Hill & Wainwright), bds 11 Prospect
 Wainwright L. Mrs., widow, h 11 Prospect
 Wait Joseph N., tea peddler, h 1 Pleasant
 Waite Betsey and Lucy B. Misses, h 8 Summer
 Walker Duncan, machinist W Mills, h Pleasant
 Wall James, farmer, h Lovefield
 Wall James, emp V Mach Co., bds Clifford
 Wall Mary, widow Walter, h Holyoke
 Wall Michael, farm hand, bds Lovefield
 Wall Thomas engineer V Mach Co., h N M Co. No 1, Clifford
 Walshe R. F. Rev., pastor R C church, h Adams
 Ward Joseph H., overseer and engineer E R T Co., h 17 Center
 Ward Oscar, overseer leather room N Mfg Co., and Sewing Mach agt,
 h Williston av
 Ware Clarence E., overseer belt and roil shop W Mills, h 65 Pleasant
 Warner Chester, emp Hampton creamery, h S Main
 Warner Emeline, widow Levi, h 10 Union
 Warner John, driver for Dr. Winslow, h over blacksmith shop, School
 Webber Clara, widow Fred, h Holyoke
 Webber Emeline, widow, rem to Agawam

- Webber John F., emp E R T Co., h Payson
 Webber John J., emp G E F Co, bds Holyoke
 Weber Anton, emp G E F Co., h Clark
 Weber Clara, widow Fred, h Holyoke
 Webster Odell G., silk mfr at Glenwood, h 28 High
 Weildhaas George, emp office N Mfg Co., bds Payson
 Welch James, emp W Mills, h Lovefield
 Welch Margaret, widow John, h Lovefield
 Welch Patrick, laborer, h 6 Ferry
 Wells Sarah B., widow John H., h Payson av
 West Eliza Miss, bds 61 Pleasant
 Western Union Telegraph Co., office N H & N R R depot
 Wetherbee Clinton W., (Wetherbee & Bemis), h 65 Main
WETHERBEE & BEMIS, (Clinton W. Wetherbee, George W. Bemis), meat market, 67 Main. [See p 298.]
 Whalen Daniel, farm hand, h 56 Emerald
 Whalen John, farmer, h Clifford
 Whalen Patrick, rem to Canada
 Wheeler Ambrose, h Briggs
 Wheeler Elma H. Miss, rem to Middlefield, Mass
 White Clarence H., clerk J. E. Lambie & Co., h 14 High
 White Elizabeth, widow John, h Gaston
 White Francis, widow Edson, h Park
 White H. L., section man N H & N R R, bds Payson
 White Oliver T., farmer, h South Park, opp South
 Whitehead Charles F., rem to Conn
 Whitin E., rem to New Haven, Conn
 Whitmarsh Fordyce, carpenter, h 6 Summer
 Whitmarsh Sarah E. Miss, teacher, Loudville, h 6 Summer
 Wilcox Marion, A. M., teacher modern languages, W Sem, rooms 43,
 44 North Hall
 Wild John M., emp E R T Co., h Stonepath Lane
 Wild Peter, h N M Co, No 6, Clifford
 Wilder Henry S., postmaster, printer, groceries, etc., Mt. Tom, h do
 Willard David, farmhand, h 24 Ferry
 Willard John H., teacher music in public schools, h 46 Pleasant
 Willett Peter, carpenter, h Clark
 Williams George R., livery stable, r 3 Union, h 8 do
 Williams Ira G., rem to Holyoke
 Williams Oscar S., rem to Holyoke
 Williams Willie, rem to Holyoke
 Williston Emily, widow Samuel, h 12 Park
WILLISTON MILLS, mfrs of cotton yarns, Pleasant. [See p 287.]
 Williston Seminary, Main c Union
WILLISTON & KNIGHT CO., mfrs of covered buttons, junc
 Union and Payson. [See p 290.]
 Wilson Joseph W. (Rust, Wilson & Co.), town clerk, h Main c Glen-
 dale
 Wing Desire Miss, bds Main opp Payson Lane
 Winslow Joseph W., physician and surgeon, office 11 Park, h do

- Witherell Benjamin S., h Park
 Witt Hulda Miss, bds School
 Wolfe Francis, emp N Mfg Co., bds Clark
 Wood Edward E., bds Mountain
 Wood Enoch, farmer, h Mountain
WOOD EUGENE W., grocer, dry goods, boots, shoes, &c., Union
 n Payson, h Main c Payson Lane. [Sec p 294.]
 Wood George S., clerk post office, bds 6 Union
 Wood Hattie E. Miss, emp W & K Co., bds Holyoke
 Wood John, emp E R T Co., h Clark n Franklin
 Wood Martin, laborer, h South
 Wood Montrose D., clerk E. W. Wood, h 14 Prospect
 Wood Newton, carpenter, h Holyoke
 Wood Sarah Miss, bds Mountain
 Wood Spencer C., tea peddler, h 6 Union
 Wood Thomas, boss dyer N Mfg Co., bds 21 Liberty
 Wright Charles E., engineer Mt Tom branch C R R, h Cottage n
 N Mfg Co mill
 Wright Ellen Miss, h S Main
 Wright Lucy, widow John, h South Main
 Wright Luther L., farmer, h S Main
 Wright Mary Miss, teacher S Main St. school, bds S Main
 Wright Richard, laborer, bds Mountain
 Wright Sarah Miss, h S Main
 Wright Watson, surveyor and farmer, h S Main

ZEPPENFELD FRANK, farm hand, bds East, Mt Tom

HUMPHREY MACHINE COMPANY,

KEENE, N. H.

Manufacturers of the

IMPROVED **I-X-L** - **X-L-C-R** AND **X-S** TURBINES.

SHAFTING, GEARING AND MILL WORK.

Humphrey's Automatic Coupler for Auxiliary Motors.

ROTARY FORCE PUMPS,

(UNSURPASSED IN EXCELLENCE),

With Traction Gearing, Hydrants, Sprinklers, and other Fire Protections for Mills, Etc.

Also, General and Special Wood Working Machinery, comprising Band Saws, Saw Mills, Board Jointers, Planers and Matchers, Tub, Pail, Clothes-Pin and Shoe-Peg Machinery, Etc., Etc.

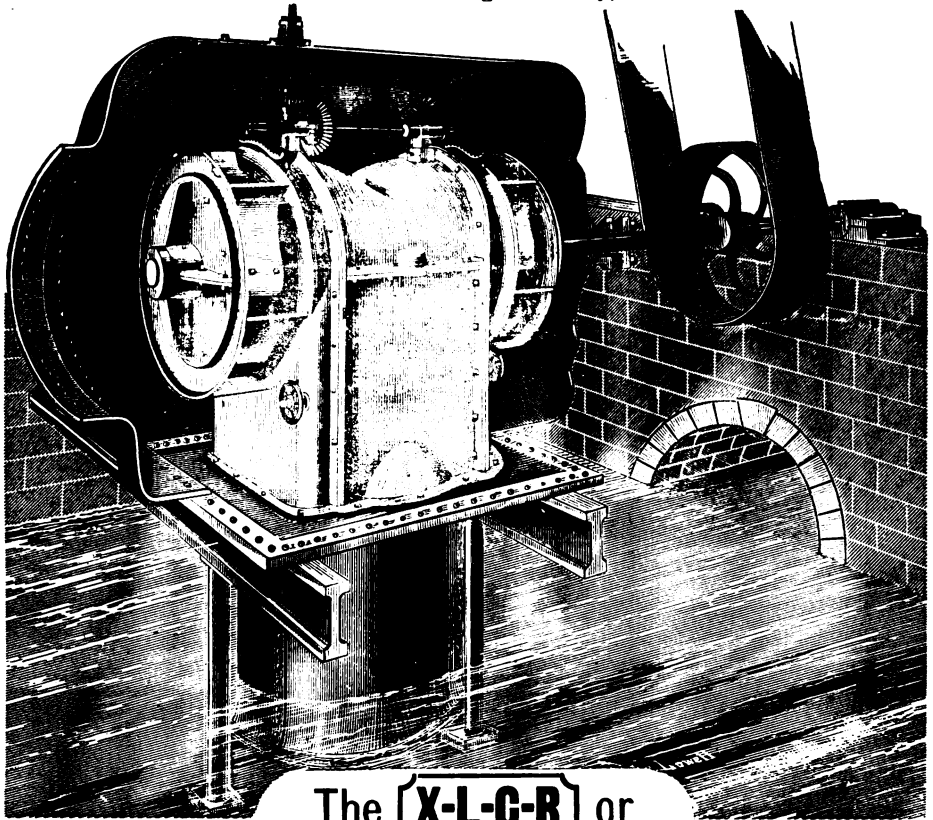

The **X-L-C-R** or

IMPROVED CIRCUMSHOT WATER WHEEL,
ON HORIZONTAL SHAFT.

Saves cost, annoyance and loss of power incident to use of gears; and having the same superior qualities of the I X L, it makes—wherever applicable—an efficient and desirable motor, invariably proving satisfactory and popular wherever introduced.

● **THE X-S TURBINE** Diminutive in Size, mighty in power,
and great capacity to use water.

Designed expressly for situations where limitation of space, or cost, is more important than the highest useful effect from the water. NOT RECOMMENDED FOR ECONOMY, as the excessive application of water always involves loss of efficiency, which is generally unprofitable, and often positively wasteful, particularly on falls of moderate height; but when a departure from correct principles is desired, the X S is specially applicable with any degree of excess from the least to the greatest practical limit. Its "possibilities" in this line are not exceeded by any other wheel yet produced.

The I-X-L is X-L-NT and UN-X-LD.

SEE OTHER SIDE.

HUMPHREY'S

IMPROVED



TURBINE,

A STANDARD

WATER WHEEL.

X-L-NT

UN-X-LD

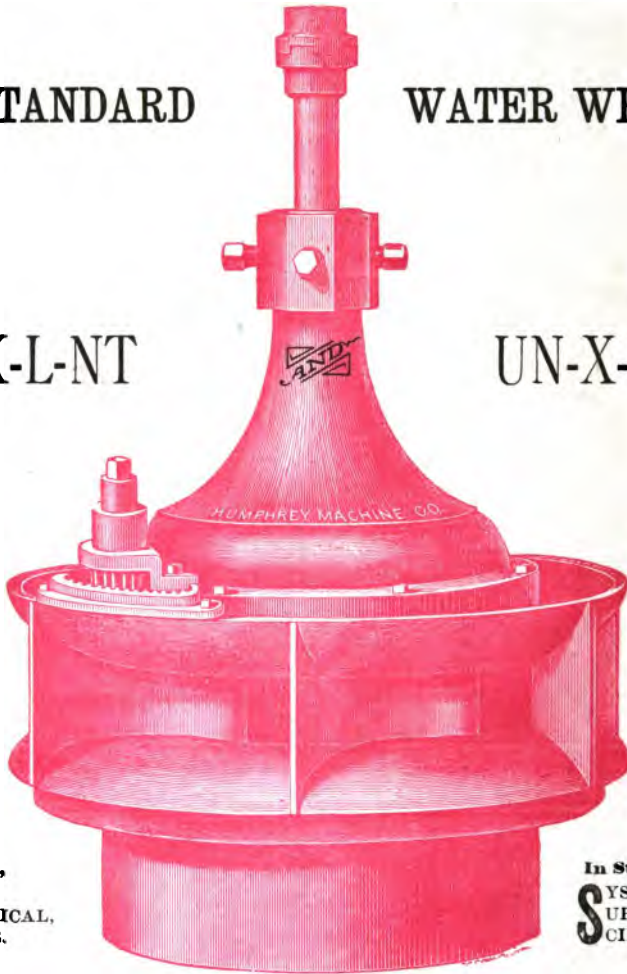

In Style,
SIMPLE,
SYMMETRICAL,
SENSIBLE.

In Structure,
SYSTEMATIC,
SUBSTANTIAL,
SCIENTIFIC.

In Service,
STRONG,
STEADY,
SERVICEABLE

And in General Application,
SUFFICIENT,
SUCCESSFUL,
SATISFACTORY.

SPECIALY
SUITABLE IN ALL
SITUATIONS

Wherever the SAVING OF WATER is desirable.

MANUFACTURED BY THE

HUMPHREY MACHINE COMPANY,

Keene, N. H.,

BUILDERS OF THE IXL, XLCR AND XS TURBINES.

Also, General and Special Machinery in great variety.

SEE OTHER SIDE.

Easthampton Business Directory.

Abdominal Supporter Manufacturer.

Dibble L. N., 15 Summer

Agricultural Tools.

NEWKIRK FRANK P., Mayher's blk, 59 Main. (See p 297.)

Apothecaries and Druggists.

Loomis J. A., Bosworth's blk, Union

SMITH CHARLES J., Winslow's blk, 45 Main. (See p 296.)

Asphalt Paver.

SIMPSON J. B., office F. P. Newkirk's hardware store, 59 Main,
home office, Newton, Mass. (See p 281.)

Attorneys-at-Law.

Bassett William G., Park n Center, and 74 Main, Northampton

Fargo A. J., 47 Main

HILL & WAINWRIGHT, 11 Prospect, also over N I for Savings,
Main, Northampton. (See p 243.)

Auctioneer.

CLARK JAIRUS E., N H & N depot. (See p 301.)

Baker.

Fadisch Charles A., 37 Main

Bands.

Easthampton Cornet Band, James Smith, leader, Manhan Hall

Easthampton Social Orchestra, A. N. Baldwin, leader, 47 Main

Banks.

Easthampton Savings Bank ; inc. 1869 ; John Mayher, pres. ; Samuel
T. Seelye, treas. ; O. G. Webster, sec. ; Bank bdg, Main

First National Bank of Easthampton ; inc. 1864 ; capital, \$200,000 ;
surplus, \$50,000 ; Samuel T. Seelye, pres. ; Charles H. John-
son, cashier ; Walter L. Boyden, teller ; Bank bdg, Main

Barber Shops.

Brunnell Frank X., 41 Main
 MEIER GEORGE A., Merrill's blk, 31 Main. (See p 300.)

Bath Rooms.

MEIER GEORGE A., Merrill's blk, 31 Main. (See p 300.)

Bill Poster.

Morrison James, Pleasant c Prospect

Billiard Hall.

HILL WILLIAM, Mansion House. (See p 300.)

Blacksmiths.

Hartwell Wilbur F., Mill
 Holcomb Norman A., off Liberty n Smith & Jordan's grist mill
 Judd Emerson B., School
 Lyman Wm. J., rear 75 Main

Boarding Houses.

Clark Dwight L, W & K, 3-4, Union
 Davis Lewis, 36 Cottage
 Flint Orville, 21 Liberty n C R R R depot
 Ludden C. B. Miss, 5 Center
 Pratt R. A., Payson
 Rice H. C., 2 Union

Booksellers and Stationers.

Alvord Edward S., 47 Main
 Putnam F. H. & Co., 43 Main

Boot and Shoe Dealers.

Baldwin's Boot and Shoe Store, 33 Main
 Lyman A. J., 77 Main
 Langdon H. A., Gould's blk, Union
 Mann A. A., 75 Main
 Putnam F. H. & Co., 43 Main
 WOOD E. W., Union n Payson. (See p 294.)

Boot and Shoe Makers.

Freil John, 37 Union
 Green Peter H., 41 Main
 JUDD W. A. & SON, Union blk, 35 Main. (See p 296.)
 Langdon H. A., Gould's blk, Union
 Lonargan J. C., 55 Emerald Place

Bottler.

SHEEHAN W. J., Cottage. (See p 299.)

Brick Manufacturer.

RICH MARTIN, Clark n Mountain. (See p 292.)

Button Manufacturers.

WILLISTON & KNIGHT CO., junc Union & Payson. (See p 290.)

Cabinet Makers.

POMEROY T. J. & H. F., 17 Main. (See p 298.)

Calf Weaner and Cow Muzzle.

RICE H. C., 2 Union. (See p 302.)

Carpenters and Builders.

BOSWORTH E. R., Union n R R crossing. (See p 301.)

Cullen John, Holyoke

Shoals H. B., foot Mill

Spear David C., shop off Liberty n Smith & Jordan's grist mill

Taylor W. G., r 4 Summer

Carpet Dealers.

RUST, WILSON & CO., Merrill's blk, 27 and 29 Main. (See p 293.)

Carpet Manufacturers.

Barnet & Leitch (rag and yarn), Holcomb n Conn R R R

Carpet Weavers.

Barnett & Leitch (rag and yarn), Holcomb n Conn R R R

Barnett R., off Liberty n grist mill

Torrey J. E. Mrs., Torrey

Carriage Makers.

FAYHEE S. S., 10 Pleasant. (See p 300.)

Leonard C. S., Gaston n Maple

Lyman William J., rear 75 Main

Wade Lewis C., School

Cigar Manufacturers.

Hoffman Henry, Holyoke

Wagner John M., Clark c Holyoke

Civil Engineer and Surveyor.

Wright Watson H., South Main

Clothing and Gents' Furnishing Goods.

PRESTON L. M., 39 Main. (See p 294.)

RUST, WILSON & CO., Merrill's blk, 27 & 29 Main. (See p 293.)

Coal and Wood.

CLARK J. E., N H & N R R depot. (See p 301.)

Janes E. E., off Liberty n Conn R R R depot

Loomis J. A. (wood), Bosworth's bldg, Union

Concrete Paver.

SIMPSON J. B., office at F. P. Newkirk's hardware store, 59 Main,
home office, Newton, Mass. (See p 281.)

Confectionery and Fruit.

Fadisch Charles A., Union blk, 37 Main

Gallagher Daniel, Ferry

GAUGH FRED J., 19 Union. (See p 296.)

Keene James, Union n R R crossing

Conveyancer.

JOHNSON CHARLES B., Bank bldg, Main. (See p 295.)

Cotton Goods Manufacturers.

WILLISTON MILLS (yarn), Pleasant. (See p 287.)

Creamery.

Hampton Creamery Association, South Main c South

Crockery and Glassware.

Lynn Margaret Miss, Lovefield

Putnam F. H. & Co., 43 Main

SHEEHAN WILLIAM J., Cottage. (See p 299.)

WOOD E. W., Union n Payson, (See p 294.)

Dentist.

Pomeroy George H., Bank bldg, Main

Deputy Sheriff.

CLARK JAIRUS E. (Hampshire and Hampden Counties), N H &
N R R depot. (See p 301.)

Dining Rooms.

Fadisch Charles A., 37 Main

Dressmakers.

Baldwin L. N. Mrs., 3 Prospect
 Bamforth S. M. Miss, Railroad
 Bishop H. M. Mrs., 11 Main
 Burnett Ellen Mrs., 3 Pleasant
 Clark A. C. Miss, 4 Union
 Mortcn N. Miss, 17 Main
 Scott L. M., J. A & L. A., 63 Main
 Stephens Esther A. Miss, 6 Union

Dry Goods.

BRIERLEY H. D. & CO., Gould's blk, Union. (See p 294.)
 Hathaway G. H., 26 Pleasant
 LAMBIE J. E. & CO., 53 and 55 Main. (See p 294.)
 Lyman A. J., 77 Main
 RUST, WILSON & CO., Merrill's blk, 27 & 29 Main. (See p 293.)
 WOOD E. W., Union n Payson. (See p 294.)

Elastic Webbing Manufacturers.

GLENDALE ELASTIC FABRICS CO., Union. (See p 289.)
 NASHAWANNUCK MFG CO., Payson n Union. (See p 291.)

Express Company.

American Express Co., Christian Kaplinger, agt, bank bdg, Main, opp
 Williston Seminary
 United States and Canada Express Co., Christian Kaplinger, agt,
 Bank bdg, Main

Express and Jobbing.

Janes Edwin E., South Main
 Nichols Edwin J., 22 Pleasant

Fancy Goods.

BRIERLEY H. D. & CO., Gould's blk, Union. (See p 294.)
 Hathaway G. H., 26 Pleasant
 Keene James, Union n RR crossing
 LAMBIE J. E. & Co., 53 and 55 Main. (See p 294.)
 McCANDLESS, G. H., 6 Union. (See p 295.)
 Putnam F. H. & Co., 43 Main
 RUST, WILSON & CO., 27 and 29 Main. (See p 293.)

Fertilizers.

NEWKIRK FRANK P., 59 Main. (See p 297.)

Fish and Oysters.

FERRY W. C., 33 Main. (See p 298.)
 Ranney N. H., 61 Pleasant

Florist.

Howland Edward H., 11 Main

Flour and Grain.

SMITH & JORDAN, off Liberty n Conn R R R depot. (See p 299.)
 Thayer J. T., foot Mill

Furniture Repairers.

POMEROY T. J. & H. F., 17 Main. (See p 299.)

Gas Company.

Easthampton Gas Co., Liberty n Conn R R. depot

Glazier.

Robinson E., 7 Center

Grist Mills.

SMITH & JORDAN, off Liberty n Conn R R R depot. (See p 299.)
 Thayer J. T., foot Mill

Grocers.

Campbell James, Briggs c Gaston
 Hupfer Hermann, Adams c Clifford
 Kaplinger Christian, bank bldg, Main opp W Seminary
 Kilmurray M., Cottage c Chapel
 Loomis J. A., Bosworth's blk, Union
 Lyman A. J., 77 Main
 Lynn Margaret Miss, Lovefield
 SHEEHAN WILLIAM J., Cottage. (See p 299.)
 Wilder H. S., Mt. Tom
 WOOD E. W., Union n Payson. (See p 294.)

Hardware and Cutlery.

NEWKIRK FRANK P., 59 Main, Mayher's blk. (See p 297.)

Harness Makers.

JUDD W. A. & SON, 35 Main, Union blk. (See p 296.)
 Richmond Wm. L., 7 Union

Hats, Caps, &c.

PRESTON L. M., 39 Main. (See p 294.)

RUST, WILSON & CO., Merrill's blk, 27 & 29 Main. (See p 293.)

Hotel.

HILL'S MANSION HOUSE, William Hill, prop'r, Main opp the Park. (See p 300.)

Ice Cream Saloons.

Fadisch Charles A., 37 Main, Union blk

Keene James, Union n R R crossing

Ice Dealer.

Ludden A. S., 6 Center

Insurance Agents.

Hannum Edwin A., Mayher's blk, 59 Main

JOHNSON CHARLES B., Bank bldg, Main. (See p 295.)

Iron Founder.

Valley Machine Co., Payson

Jewelers.

(See Watchmakers and Jewelers.)

Laundry.

Regan John, West

Library.

Public Library Association of Easthampton, Junc Main and Park

Livery Stables.

Alvord Whitney F., rear Hill's Mansion House, Main

Campbell James, Briggs c Gaston

Davis Lewis (feed), r 36 Cottage

Morrison James, Pleasant c Prospect

Smith J. S., rear 21 Union

Williams George R., r 3 Union

Lumber Dealer.

BOSWORTH E. R., Union n R R crossing. (See p 301.)

Machine Shop.

Valley Machine Co. (steam pumps), Payson

Masons.

Fales L. G., Center
TOPLIFF WILLIAM E., 90 Main. (See p 302.)

Mason Materials.

TOPLIFF WILLIAM E., 90 Main. (See p 302.)

Meat Markets.

Dower L. W., Cottage n Pine
FERRY W. C., 33 Main. (See p 298.)
Loomis Merritt J., Chapman's blk
LUDDEN E. H., 50 Pleasant. (See p 298.)
WETHERBEE & BEMIS, 67 Main. (See p 298.)

Merchant Tailors.

Miller John A., Ionic blk, Main
PRESTON L. M., 39 Main. (See p 294.)

Milliners and Millinery.

McCANDLESS G. H., 6 Union. (See p 295.)
LAMBIE J. E. & CO., 53 and 55 Main. (See p 294.)
Mansfield B. P. Mrs., 47 Main
Parsons M. L. Miss, 11 Union
RUST, WILSON & CO, Merrill's blk, 27 & 29 Main. (See p 293.)

Music Teachers.

CLARK FRED L. (Piano, Organ and Harmony), 16 Prospect. (See
p 295.)
Kingsley Rose Miss, 6 Main

News Depots.

Alvord Edward S., Chapman's blk, 49 Main
GAUGH FRED J., 19 Union. (See p 296.)

Newspaper.

EASTHAMPTON NEWS AND ENTERPRISE (weekly), Torrey
Bros. publishers and proprietors, Ionic blk, Main. (See p 286.)

Nurses.

Beals M. A. Mrs., Hannum
 Burdick Mary Mrs., 18 Center
 Pomeroy Mrs., 16 High

Nursery.

Gaylord M. L., West

Painters and Paper Hangers.

David Alfred, Water
 Gould Frank J., Lambie's blk, Main
 Leonard C. S., Gaston
 Morrison James, Pleasant c Prospect
 Robinson E., r 7 Center
 Searle George, West
 Tibbitts James, Union
 Toogood L. O., 5 Prospect

Paints, Oils, &c.

Loomis J. A., Bosworth's blk, Union
 SMITH C. J., 47 Main. (See p 296.)

Paper Hangings.

Putnam F. H. & Co., 43 Main
 WOOD E. W., Union n Payson. (See p 294.)

Paper Manufacturers.

EASTHAMPTON PAPER CO., P. O. address, Easthampton, mill
 at Loudville. (See p 292.)

Phonographer.

MORRIS F. G., Payson Lane. (See p 295.)

Photographer.

Richardson W. P., Winslow's blk, 47 Main

Physicians and Surgeons.

Deane Henry A., 29 High
 Greene F. C., 61 Main
 Winslow Joseph W., 11 Park

Pianos and Organs.

Putnam F. H. & Co., 43 Main
McCANDLESS G. H., 5 Union. (See p 295.)

Plumbers.

NEWKIRK FRANK P., Mayher's blk, 59 Main. (See p 297.)
OWEN B. P., Union n R R crossing. (See p 297.)

Post Offices.

Easthampton Post Office, Merrill's blk, J. H. Bardwell, Postmaster
Mt Tom Post Office, H. S. Wilder, Postmaster

Poultry Dealer.

Clark F. W., 16 Prospect

Printers—Book and Job.

TORREY BROS., Easthampton News office, Ionic blk, Main. (See
p 286)
Wilder H. S., Mt Tom

Real Estate Agent.

JOHNSON CHARLES B., bank bldg, Main. (See p 295.)

Rubber Goods Manufacturers.

EASTHAMPTON RUBBER THREAD CO. (thread), Payson n R
R crossing. (See p 288)
GLENDALE ELASTIC FABRICS CO., Union. (See p 289.)
NASHAWANNUCK MFG CO., mfrs elastic webbing, suspenders,
&c., Payson av n Union. (See p 291.)

Saloons.

Gallagher Daniel, Parsons
Kaepfel A. M. Mrs., Pine
SHEEHAN WILLIAM J., Cottage. (See p 299.)

Saw Mill.

RICH MARTIN, Clark n Mountain. (See p 292.)

Seminary.

Williston Seminary, Main c Union

Sewing Machine Belting.

Avery G. H., r 8 Pleasant

Sewing Machines.

McCANDLESS G. H., 5 Union. (See p 295.)

Putnam F. H. & Co., 43 Main

Ward Oscar, Williston av

Shoulder Brace Manufacturers.

COLTON GEO. S., 59 Pleasant. (See p 292.)

Dibble L. N., r 15 Summer

Dibble N. O., S Main

Steam Heating Apparatus.

Manchester George L., Liberty

Steam Pump Manufacturers.

Valley Machine Co., Payson

Steam and Gas Fitter.

Manchester George L., Liberty

Steamship Ticket Agent.

Kaplinger Christian, bank bldg, Main

SHEEHAN W. J., Cottage. (See p 299.)

Stove Dealers and Tinsmiths.

NEWKIRK F. P., 59 Main, Mayher's blk. (See p 297.)

OWEN B. P., Union n R R crossing. (See p 297.)

Suspender Manufacturers.

NASHAWANNUCK MFG CO., Payson n Union. (See p 291.)

Tailors.

Schicker Paul, Gaston

Tea Peddlers.

Wait J. N., 1 Pleasant

Wood S. C., 6 Union

Telegraph Company.

Western Union Telegraph Co., Miss Eva M. Judd, operator, N H & N depot

Telephone Office.

SMITH CHARLES J., 45 Main. (See p 296.)

Thread Manufacturers.

EASTHAMPTON RUBBER THREAD CO., Payson n R R crossing. (See p 288.)

Truckmen.

Janes E. E., Union at Langdon's store, h S Main
Munyan John W., Union, h Center

Trunks and Bags.

JUDD W. A. & SON, 35 Main. (See p 296.)
Richmond William L., 7 Union

Watchmakers and Jewelers.

Alvord Edward S., 47 Main, Chapman's blk
Street W. W., 43 Main

Undertakers.

POMEROY T. J. & H. F., 17 Main. (See p 299.)

Upholsterers.

POMEROY T. J. & H. F., 17 Main. (See p 299)
Spooner A. T., 9 Summer

Whip Lash Manufacturer.

Avery G. H., r 8 Pleasant

Yarn Manufacturers.

WILLISTON MILLS, Pleasant. (See p 287.)

Easthampton Town Government.

TOWN OFFICERS.

Selectmen, Assessors, and Overseers of the Poor, Edwin R. Bosworth, chairman ; Luther B. Searle, Almon S. Ludden.

Treasurer, Lucius Preston.

Town Clerk, Joseph W. Wilson.

School Committee, Joseph H. Sawyer, Watson H. Wright, James H. Lyman.

Road Commissioners, Almon S. Ludden, Henry T. Hannum, Lewis S. Clark.

Collector of Taxes, Alburn J. Fargo.

Town Hall Committee, Edwin R. Bosworth, Joseph H. Ward, Jairus E. Clark.

Constables, Jairus E. Clark, Marshall D. Strong, Charles H. Upson, Austin Fairchild, Frank H. Kimball.

Police, Daniel Dwyer.

Committee on Brookside Cemetery, E. Thomas Sawyer, Edwin S. Janes, Luther B. Searle.

Committee in Charge of Williston (Main Street Cemetery) Fund, Horatio G. Knight, Wm. G. Bassett, Wm. Hill.

Fire Engineers, Jairus E. Clark, Chief ; Clarence E. Ware, E. Thomas Sawyer, Lawrence W. Dower.

Surveyors of Wood and Bark, Frank P. Newkirk, Joseph F. Finch, Frank D. Barnes.

Surveyors of Lumber, Frank O. Rosebrook, Wm. E. Spooner.

Sealer of Weights and Measures, Frank H. Pomeroy.

Justics of the Peace, William G. Bassett, Patrick J. Ashe, Jeremiah H. Bardwell, A. J. Fargo, E. A. Hannum, Charles B. Johnson, H. W. Wilson, J. Arthur Wainwright, Samuel T. Seelye, B. Parsons Mansfield, Horace L. Clark, Horatio G. Knight.

Notaries Public, William G. Bassett, Emil C. Koenig, Albert D. Sanders, David Hill, Charles H. Johnson.

PIPE DEPARTMENT

Chief Engineer James E. Park, *Assistants*, Lawrence E. Ware,
E. Thomas Sawyer, Lawrence V. Tower.

STEAM ENGINE COMPANY.

Foreman, Andrew Viener.

EASTHAMPTON HACK AND CARTER COMPANY.

Foreman, L. N. Bardon.

HOSE COMPANY NO. 1.

Foreman, Stephen K. Buesner.

HOSE COMPANY NO. 2.**PUBLIC SCHOOLS.**

BOARD OF EDUCATION. J. H. Sawyer, W. H. Wright, J. H. Lyman.

SCHOOLS AND TEACHERS.

HIGH AND GRAMMAR SCHOOL.—Miss S. E. Chapin, *Principal*; Miss L. S. Smith, Miss S. E. Butler, Miss A. C. Cutting, *Assistants*; John H. Willard, *Music Teacher*; Miss L. A. Mattoon, *Teacher of Penmanship*. Located Manhan cor. Pleasant.

CENTER INTERMEDIATE AND PRIMARY.—Miss M. A. Strong, *Principal*; Miss S. G. Lyman, Miss F. Pomeroy, *Assistants*. Seven grades. Located on School street.

NASHAWANNUCK INTERMEDIATE AND PRIMARY SCHOOL.—Miss A. M. Munyan, *Principal*; Miss A. S. Matthews, Miss A. C. Parsons, Miss F. E. Spooner, Miss H. G. Lyman, *Assistants*. Seven grades. Located on Chapel street.

WILLISTON MILLS INTERMEDIATE AND PRIMARY SCHOOL.—Mrs. H. W. Lea, *Principal*; Miss R. A. Searle, Miss Mary Martin, *Assistants*. Seven grades. Located Lovefield street and Emerald place.

UNGRADED SCHOOLS.—Main St. School, Miss M. C. Wright; East St. School, Miss N. D. Clark; North St. School, Miss B. Marshall; West St. School, Miss J. R. Merriam; Park St. School, Miss E. Clark; Mountain St. School, Miss I. Kimball; Glendale St. School, Miss E. M. Torrey.

WILLISTON SEMINARY.

TRUSTEES.

Prof. William S. Tyler, D. D., LL.D., *President*, Amherst.
 Rev. S. G. Buckingham, D. D., Springfield.
 Rev. John H. Bisbee, Westfield.
 Col. William S. Clark, LL.D., Amherst.
 Rev. Samuel T. Seelye, D. D., Easthampton.
 Hon. Horatio G. Knight, Easthampton.
 M. F. Dickinson, Jr., Esq., Boston.
 A. Lyman Williston, Esq., *Treasurer*, Northampton.
 Joseph W. Fairbanks, Ph. D., *Secretary*, Easthampton.
 Prof. Richard H. Mather, D. D., Amherst.
 John C. Hammond, Esq., Northampton.
 Rev. Alexander R. Merriam, Easthampton.
 Prof. Tracy Peck, A. M., New Haven.

FACULTY.

Joseph Whitcomb Fairbanks, Ph. D., *Principal*.
 Joseph Henry Sawyer, A. M., Mental Science and English Literature.
 Robert Porter Keep, Ph. D., Greek and German.
 Edward L. Gulick, A. B., Mathematics and Physics.
 Charles Albert Buffum, A. M., Latin and History.
 Alfred Chapman Hand, A. B., Elocution and Physical Education.
 Nathan Augustus Cobb, B. S., Natural Science and Drawing.
 Marion Wilcox, A. M., Modern Languages.
 Henry Lefavour, A. B., Arithmetic, Grammar and History.

CHURCHES.

FIRST CONGREGATIONAL CHURCH.

Manhan near Pleasant.

Pastor, Rev. W. F. Bacon ; *Deacons*, Lauren D. Lyman, John W. Munyan, John H. Judd, Lucius E. Parsons ; *Church Clerk*, M. L. Gaylord ; *Treasurer*, Lucius E. Parsons ; *Society Clerk*, W. L. Wright ; *Treasurer*, L. N. Baldwin ; *Superintendent of Sabbath School*, Henry A. Parsons ; *Librarian*, ————.

PAYSON CONGREGATIONAL CHURCH.

Pastor, ———— ; *Clerk*, Charles B. Johnson ; *Deacons*, Charles B. Johnson, Joseph H. Sawyer, Joseph W. Wilson, Albert D. Sanders ; *Society Clerk*, Horace L. Clark ; *Society Treasurer*, Lucius Preston ; *Standing Committee*, Samuel T. Seelye, Granville H. Leonard, Luther B. Searle.

ST. PHILIP'S EPISCOPAL CHURCH.

Warden, Thomas Butterworth ; *Treasurer*, William Taylor. Meet at Union Chapel, Chapel Street, at 10.30 A. M. and 7.30 P. M. each Sabbath.

EASTHAMPTON M. E. CHURCH.

Main near Town Hall.

Pastor, John Galbraith ; *Local Preacher*, Franklin Morris ; *Trustees*, O. H. Hill, O. F. Hill, M. J. Loomis, D. C. Torrey, G. W. Bemis, P. Bishop, George E. Searle, J. A. Loomis, A. A. Howard ; *Stewards*, O. H. Hill, O. F. Hill, L. E. Torrey, D. C. Torrey, Reuben Angevine, J. A. Loomis, H. A. Langdon, George H. McCandless, Henry Halford, P. Bishop ; *Superintendent of Sabbath School*, J. A. Loomis ; *Organist*, ———— ; *Chorister*, O. H. Hill.

CHURCH OF THE IMMACULATE CONCEPTION.

(Roman Catholic) Adams Street.

Pastor, Rev. R. F. Walshe.

MASONIC.

IONIC LODGE, F. & A. M.

Regular Communication on or next preceding each full moon.

W. M., Clarence E. Ware ; *S. W.*, Joseph Bassett ; *J. W.*, Charles E. Ferry ; *Treas. and Trustee*, Francis C. Greene ; *Sec.*, Justin H. Bassett ; *Chaplain*, Joshua A. Loomis ; *Marshal*, Charles C. Loud ; *S. D.*, Odell G. Webster ; *J. D.*, Rufus A. Frissell ; *S. S.*, Lewis T. Ford ; *J. S.*, George M. Rich ; *I. S.*, Dwight Hathaway ; *Organist and Chorister*, Edwin S. Janes ; *Tyler*, Lyman N. Baldwin.

DORIC CHAPTER, ORDER EASTERN STAR.

Regular meetings Tuesday evenings on or next preceding each full mon.

W. M., Mrs. Lucinda Farrar ; *W. P.*, Mr. Joseph Bassett ; *A. M.*, Mrs. Emily Bassett ; *Treas.*, Mrs. Lona L. Goodenough ; *Sec.*, Mrs. Harriet M. Baldwin ; *Con.*, Mrs. Lucius Aldrich ; *A. C.*, Mrs. Ardelia Burnham ; *Chap.*, Mrs. Maria A. Chase ; *Adah*, Miss Florence Spooner ; *Ruth*, Ellen Stevens ; *Esther*, Mrs. Ellen L. Chamberlain ; *Martha*, Mrs. Nancy Hill ; *Electa*, Miss Hulda Ford ; *War.*, Mrs. Maria Hathaway ; *Sen.*, Mr. N. W. Farrar.

KNIGHTS OF HONOR.

HOPE LODGE, NO. 1184.

Meetings in Knights of Honor Hall, 1st and 3d Wednesdays of each month.

Reporter, Lyman N. Baldwin ; *Treas.*, C. J. Smith.

SOCIETIES, &c.

EASTHAMPTON PUBLIC LIBRARY ASSOCIATION.

Organized April, 1869 ; opened to the public Sept. 13, 1869 ; located at junction Main, Park and South Main. No. of vols. in library, 6,643. *Officers.*—S. T. Seelye, D. D., *Pres.* ; Judge W. G. Bassett, *Vice Pres.* ; Dr. S. C. Green, *Sec.* ; H. H. Sawyer, *Treas.* ; Miss D. C. Miller, *Librarian* ; Dwight Strong, *Janitor.* *Directors*, J. W. Fairbanks, E. T. Sawyer, John Mayher, J. W. Green, Jr. *Library Hours*, from 2 to 5 and 6 to 9 Wednesday and Friday. Saturday evening, 6 to 9 P. M.

WOMEN'S CHRISTIAN TEMPERANCE UNION.

Meets 1st and 3d Tuesday of each month at parlors Payson Church.

Pres., Mrs. Wm. Richmond ; *Vice Presidents*, Mrs. S. T. Seelye, Mrs. E. H. Ludden, Mrs. A. M. Colton, Mrs. Alex. Merriam, Mrs. Harriet L. Parsons, Mrs. L. E. Torrey ; Mrs. O. H. Hill ; *Sec and Treas.*, Miss Sarah E. Wright.

GERMAN SOCIETY OF EASTHAMPTON.

President, Richard F. Koehler ; *Vice President*, Alvin Riedel ; *Treasurer*, Herman Hupfer ; *Directors*, Henry Hoffman, Rudolph Voigt, Louis Roehnig, Herman Eger, Oscar Hillert, John Wild ; *Secretary*, R. Uebel ; *Committee of Finance*, L. F. Koehler, Louis Bartosh, Anton Griesbach ; *Auditor*, Charles Uebel. Meetings at German Hall, Clark street.

ST. JOSEPH'S TEMPERANCE SOCIETY.

Meetings 1st and 3d Thursday evenings of each month at Chapman's Hall

Pres., Simon J. Connery ; *Vice Pres.*, Patrick Dwyer ; *Sec.*, M. F. Griffin ; *Treas.*, Daniel Dwyer.

EASTHAMPTON POST OFFICE.

J. H. Bardwell, Postmaster.

MAILS CLOSE.

North, South Deerfield, Sunderland, Greenfield, Shelburne Falls, Vermont, Western New Hampshire, Canada East, Stations on Vermont & Mass. R. R., Hatfield, Whately, Deerfield, Conway, Ashfield, Plainfield, Northampton, 7.45 A. M., 12.20 P. M. Northampton, Florence, Leeds, Haydenville, Williamsburg, 12.20 and 8.15 P. M. Westhampton, Loudville, Goshen, Cummington, Chesterfield, Hadley, North Hadley, Amherst, Prescott, Pelham, Shutesbury, New Salem, 12.30 P. M.

South, All stations to New York and South, Connecticut and Rhode Island, 11.00 A. M., 5.30 P. M.

East, Eastern Way and Boston, Springfield, 11.00 A. M., 5.30 P. M. Holyoke, Chicopee, Chicopee Falls, Granby, South Hadley, South Hadley Falls, 8.15 P. M.

West, Pittsfield and Western Way ; Westfield, all stations via N. H. & N. R. R. to New Haven and New York, 11.00 A. M., 5.30 P. M.

MAILS OPEN.

North, South Deerfield, Sunderland, Greenfield, Shelburne Falls, Vermont, Western New Hampshire, Canada East, Stations on Vermont & Mass. R. R., Hatfield, Whately, Deerfield, Conway, Ashfield, Plainfield, Northampton, 12.45 P. M. Northampton, Florence, Leeds, Haydenville, Williamsburg, Westhampton, Loudville, Goshen, Cummington, Chesterfield, Hadley, North Hadley, Amherst, Prescott, Pelham, Shutesbury and New Salem, 11.45 A. M., 6.15 P. M.

South, All stations to New York and South, Connecticut and Rhode Island, 7.00 and 9.30 A. M., 1.00 P. M.

East, Eastern Way and Boston, 10.00 A. M., 6.15 P. M.; Springfield, 9.15 A. M.; Holyoke, Chicopee, Chicopee Falls, Granby, South Hadley, South Hadley Falls, 10.00 A., M.

West, Pittsfield and Western Way, Westfield, all stations via N. H. & N. R. R., to New Haven and New York, 7.00 A. M., 1.00 P. M. Northern New York and the West, 9.30 A. M.

STOCK COMPANIES.

EASTHAMPTON GAS CO.

Capital, \$30,000. *Pres.*, E. Thomas Sawyer; *Treas.*, Horace L. Clark; *Supt.*, George L. Manchester. Works Liberty near Conn. R. R. depot.

EASTHAMPTON RUBBER THREAD CO.

Incorporated 1864; Capital Stock, \$200,000. *Pres.*, Horatio G. Knight; *Treas and Gen. Agt.*, E. Thomas Sawyer. Payson n R. R.

EASTHAMPTON LIVE STOCK CO.

Headquarters Greeley, Colorado; Incorporated, 1883; Capital Stock \$200,000; office, First National Bank, Easthampton. *Pres.*, Samuel T. Seelye; *Treas.*, Albert D. Sanders; *Sec.*, Charles H. Johnson; *Manager*, James O. Gale.

EASTHAMPTON PAPER CO.

Incorporated May 1st, 1883; Capital Stock, \$30,000. *Pres.*, A. B. Harris, Springfield; *Treas. and Manager*, C. A. Crocker, Paper Manufacturers, at Loudville.

GLENDALE ELASTIC FABRICS CO.

Incorporated 1867 ; Capital Stock, \$200,000. *Pres.*, Samuel T. Seelye ; *Treas. and Manager*, Joseph W. Green, Jr.

HAMPTON CREAMERY ASSOCIATION.

Incorporated Jan. 1, 1881 ; Capital Stock, \$2,500. *Pres.*, James H. Lyman ; *Treas.*, Theoron Pomeroy ; *Clerk*, W. H. Wright. South Main corner South.

NASHAWANNUCK MANUFACTURING CO.

Incorporated 1850 ; Capital Stock, \$300,000. *Pres.*, Christopher Meyer, New York ; *Treas.*, George H. Newman ; *Mfg. Agt.*, G. H. Leonard ; *Selling Agt.*, E. D. Candee, New York. Payson n Union.

WILLISTON MILLS.

Incorporated 1866 ; Capital Stock, \$350,000.. *Pres.*, Franklin W. Pitcher, Boston, Mass. ; *Treas.*, Henry C. Morse, Boston, Mass. ; *Selling Agt.*, Henry C. Morse, Boston, Mass. ; *Resident Agt.*, Isaac Russell ; *Paymaster*, Albert E. Abbott. Cotton yarns ; office and mills Pleasaut near R. R. crossing.

WILLISTON & KNIGHT CO.

Incorporated 1865 ; Capital Stock, \$150,000. *Pres. and Treas.*, Horatio G. Knight ; *Sec.*, Horace L. Clark. Button mfrs. Junction Union and Payson.

THE AMERICAN PHOTO-LITHOGRAPHIC CO.,

Established 1866.

OFFICE (EVENING POST BUILDING), 206 & 208 BROADWAY, N. Y.

ARE PREPARED TO COPY

LINE ENGRAVINGS,	WOOD ENGRAVINGS,	PRINTED LETTER-PRESS,
LITHOGRAPHS,	MUSIC,	MAPS, Drawn or Engraved,
ARTISTIC PEN DRAWING,	ARCHITECTURAL PLANS,	MECHANICAL DRAWINGS,
MANUSCRIPT LETTERS,	DOCUMENTS,	ENGINEER'S PLANS,

AND EVERY VARIETY OF LINE WORK BY

OSBORNE'S PROCESS OF PHOTO-LITHOGRAPHY,

IN THE HIGHEST STYLE OF THE ART.

Copies may be had in fac-simile and of any size, whether enlarged, reduced, or of full scale, with absolute accuracy and economy, the transfers being made by Photography instead of the hand of an artist.

Drawings should be done IN LINE, with Black (Indian) Ink, on smooth white paper. The process is not adapted to ordinary photographs, possessing half-tones or tints and views direct from nature, nor drawings shaded in ink or water colors. These are first traced or drawn by our artists in lines. The advantages of this process commercially and artistically are very many, and its products excite general admiration.

We call particular attention to our

PHOTO-RELIEF PLATES

for Letter-press printing. A superior substitute for woodcuts, at much lower rates. Originals should be forwarded rolled (not folded), when possible.

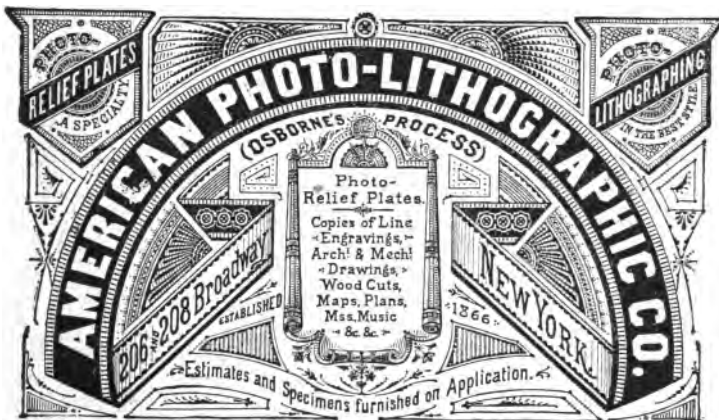



AMERICAN



PHOTO-ENGRAVING

OSBORNE'S
PROCESS.

Reproduce in
Fac simile
LINE ENGRAVINGS,
WOOD CUTS, MAPS,
PLANS, ARCHITECTURAL
AND MECHANICAL DRAWINGS,
PRINTED MATTER, MSS., MUSIC ETC.
FULL SCALE, ENLARGED OR REDUCED.

**Photo-Engraving,
LITHOGRAPHING
AND
PHOTO-LITHOGRAPHING**
of Superior Excellence.

ESTIMATES FURNISHED ON APPLICATION.



206 & 208 BROADWAY, N.Y.

NORTHAMPTON INSTITUTION FOR SAVINGS.

This Bank was incorporated March 1, 1842, C. P. Huntington, President ; S. L. Hinckley, Secretary and Treasurer ; at whose office the business was transacted. It was afterwards located on Pleasant street over the store of O. A. Skilton, when Dr. Benjamin Barrett was Treasurer ; and afterwards over the Northampton National Bank. In 1876, the site between the First Church and Court House was purchased, and a handsome banking house erected, at a cost of \$27,000. The management of this Institution has been such that it enjoys the entire confidence of the community. Its losses have been few and small, while the business transacted has been very large. The deposits now amount to \$1, 970, 000.

PRESIDENT.—H. G. Knight, Easthampton.

VICE PRESIDENTS.—Eleazar Porter, Hadley ; M. M. French, Northampton.

TRUSTEES.—George W. Hubbard, Oscar Edwards, James L. Warriner, Henry R. Hinckley, Merritt Clark, Timothy G. Spaulding, J. Stebbins Lathrop George P. Dickinson, Northampton ; Matthew Smith, Middlefield ; F. H. Dawes, Cummington ; S. M. Cook, Granby ; Elisha Hubbard, Hatfield ; William E. Thayer, Williamsburg ; E. A. Thomas, Amherst.

SECRETARY.—T. G. Spaulding.

TREASURER.—L. Maltby.

ESTABLISHED 1873

PRICE, LEE & CO.,

DIRECTORY PUBLISHERS,

YALE BANK BUILDING,
Corner State and Chapel Streets, }

NEW HAVEN, CT.

The following Directories published annually at this office :

New Haven, Bridgeport, Norwich, Waterbury, Meriden, Bristol, Plainville, Southington, Derby, Winsted and Torrington, in Ct. ; Holyoke, Northampton, Easthampton, Fitchburg, in Mass.

Directories of all the principal Cities on file and for sale.

HAMPSHIRE SAVINGS BANK.

Established A. D. 1869.

DEPOSITS, - - - \$675,000.

Deposits received every business day and placed on interest the 15th of February, May, August, and November.

Interest Dividends declared on the 15th of May and November.

PRESIDENT, LUTHER BODMAN. TREASURER, LEWIS WARNER.

VICE PRESIDENTS :

Josephus Crafts, Ansel Wright, Webster Herrick, Hiram Nash.

TRUSTEES :

H. A. Longley, O. S. Clark, J. H. Demond, James Dunlap, M. W. Jackson, W. H. Dickinson, W. A. Nash, E. A. Edwards, Nat'l Day, H. P. Billings.

BANKING ROOMS AT HAMPSHIRE COUNTY NATIONAL BANK.

112 Main Street, NORTHAMPTON, MASS.

Florence Savings Bank.

DAVIS BLOCK, MAIN STREET, FLORENCE.

President, A. T. LILLY.

VICE PRESIDENTS.

H. F. CUTLER,

SAMUEL PORTER.

TRUSTEES.

**S. A. BOTTUM,
W. L. WILCOX,
E. E. WOOD,
A. G. HILL,
M. W. BOND,
ORAN STORER,**

**C. E. GOULD,
GEORGE S. GRAVES,
AMOS ELDRIDGE,
L. F. PLIMPTON,
N. A. DAVIS,
G. H. RAY,**

**H. B. HAVEN,
E. S. BOTTUM,
O. M. SMITH,
J. B. O'DONNELL.**

TREASURER, M. W. BOND.

Quarter days, the second Tuesdays of January, April, July and October.
Regular Dividends paid on the second Tuesdays of April and October.

Amount Deposited Sept 1, 1883, - \$157,698.53.

NORTHAMPTON NATIONAL BANK.

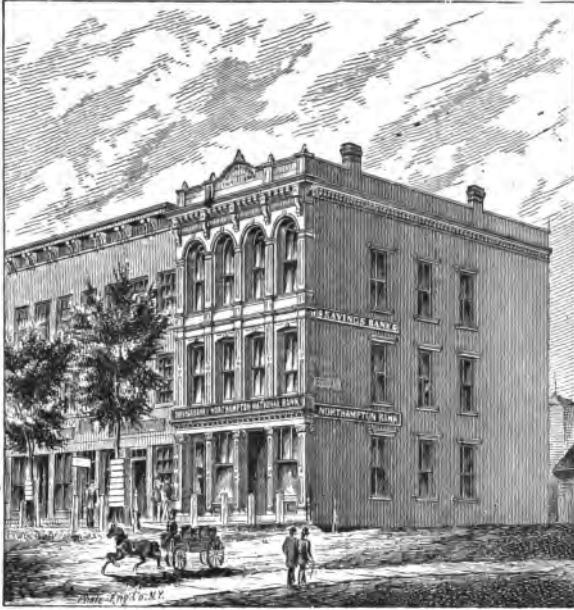

99 MAIN STREET.

The Northampton Bank was organized April 13, 1833, with a capital stock of \$100,000. Eliphalet Williams was President, and J. D. Whitney, Cashier. In 1837, the capital was increased to \$200,000. In 1865, the Bank was re-organized as the Northampton National Bank, and the capital increased to \$400,000. The Bank has always occupied the present site. In 1866, the building was remodeled and a handsome front put on. On January 26, 1876, this Bank was made notorious by the great Northampton Bank Robbery; when Bonds, certificates, money and other securities, to the amount of one and a half million of dollars, were stolen; the greater part of which, however, has been restored.

PRESIDENT.—Oscar Edwards.

VICE PRESIDENT.—J. L. Warriner.

CASHIER.—John Whittelsey.

DIRECTORS.—Oscar Edwards, Winthrop Hillyer, L. B. Williams, Geo. W. Hubbard, H. R. Hinckley, J. L. Warriner, Northampton; Eleazer Porter, Hadley; William Skinner, Holyoke; John L. Otis, Frank N. Look, Florence.

THE FIRST NATIONAL BANK

OF NORTHAMPTON.

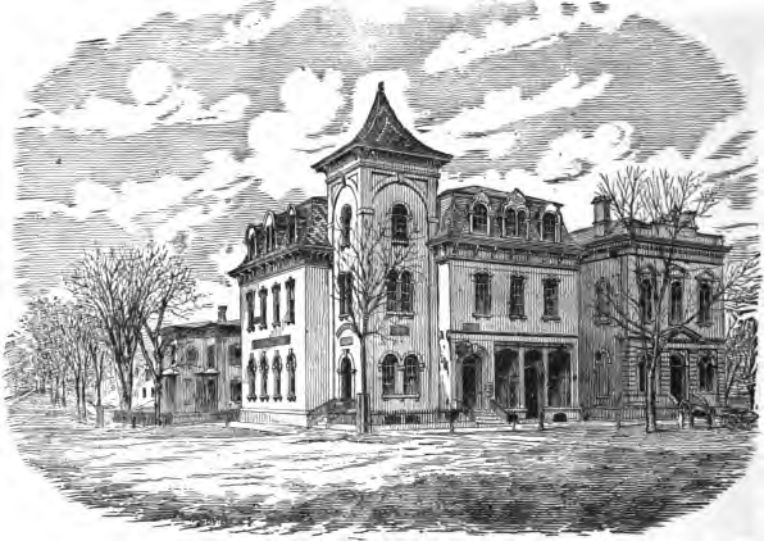

Corner Main and King Streets.

The Holyoke Bank, from which it derived its existence, was chartered in 1848 with a capital of \$100,000. John Clarke, President; and Thomas Green, Cashier. In 1849, the capital was increased to \$150,000, and in 1850 to 200,000. In 1857, Samuel Williston, of Easthampton, was made President, and William B. Hale, Cashier. In 1864, it was made a National Bank with a capital of \$300,000, and has since been known as, "The First National Bank of Northampton."

In the re-organization, Joel Hayden was chosen President; W. B. Hale, Vice President; and Henry Roberts, Cashier. Mr. Roberts had been for many years Teller of the Holyoke Bank. Mr. Hayden died in November, 1873, and Wm. B. Hale was chosen President, and Mr. Roberts continued as Cashier till his death in September, 1880, when F. N. Kneeland was appointed in his place. Mr. Roberts was a man greatly esteemed and beloved by all who knew him.

In 1865, the capital stock of the Bank was increased to \$400,000, and in 1869, to \$500,000, at which sum it now stands. Since the State law making the Bank directly liable for the tax to the stockholders, the Bank has assumed and paid those taxes to an amount exceeding \$80,000. The total amount of Dividends paid out to stockholders since its organization as a National Bank, is \$810,000 and the present reserve fund and undivided profits amount to more than \$180,000. In 1865, the present banking house, at the corner of Main and King streets, was erected, at an expense of over \$40,000. The main entrance to the banking room is on King street. The vault is built in the strongest manner, and chronometer locks guard its doors. Upon the walls of the Directors' room hang life-like portraits of the three deceased Presidents; John Clarke, Samuel Williston, and Joel Hayden; and Mr. Roberts, the late Cashier. The present officers and clerks are;

PRESIDENT.—William B. Hale.

CASHIER.—Fred. N. Kneeland.

TELLER.—George C. Averill.

BOOK-KEEPER.—Lucius C. Graves.

CLERK.—Joel Connelly.

DIRECTORS.—Silas M. Smith, Wm. B. Hale, M. H. Spaulding, M. M. French, H. F. Williams, A. L. Williston, L. J. Warner, of Northampton; Chas. Cook, of Hadley; P. M. Wells, of Whately; L. D. James, of Williamsburg; D. W. Wells, of Hatfield.

THE

Hampshire County National Bank,

112 Main Street,

NORTHAMPTON, - - MASS.

Capital,
\$250,000.

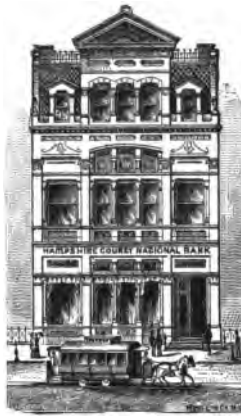

Surplus,
\$75,000.

This Bank was chartered in May, 1864, with a capital Stock of \$100,000. Luther Bodman, President ; W. C. Robinson, Cashier In 1865, Lewis Warner succeeded Mr. Robinson as Cashier, and still fills the position. The same year the capital was increased to \$250,000. In 1874, the present handsome and commodious banking house was erected, at a cost of \$26,000.

PRESIDENT.—Luther Bodman.

CASHIER.—Lewis Warner.

DIRECTORS.—Luther Bodman, Josephus Crafts, Merritt Clark, M. W. Jackson, Lewis Warner, W. H. Dickinson, Hiram Nash.

ESTABLISHED IN 1786.



HAMPSHIRE GAZETTE.



Best Advertising Medium

IN HAMPSHIRE COUNTY.

Hampshire County Journal.

A First-class Weekly Newspaper, devoted
to Local News in Hampshire County.

An excellent medium for Advertising, in Northampton, Hampshire County, and Western Massachusetts. Subscription price, \$1.50 a year by mail, to any place in Hampshire County. Delivered by carrier, \$1.75 per year. Special Rates to yearly advertisers.

WADE, WARNER & CO., Publishers.

Court Street, - NORTHAMPTON, MASS.

JOB PRINTING!

Everything in the line of Job Printing from a mammoth Poster to a fine Address Card, done at short notice, and on the most reasonable terms. All orders by mail promptly attended to.

WADE, WARNER & CO., Proprietors.

Lock Box, 264.

The Hampshire Herald!

Published Daily and Weekly.

THE ONLY DAILY IN HAMPSHIRE COUNTY.

The Daily is only One Cent per copy. It
is the Best Advertising Medium for
Northampton and Vicinity.

LARGEST AND CHEAPEST WEEKLY IN THE COUNTY.

BRIDGMAN & GAY,

Jones' Block, Court St., - NORTHAMPTON, MASS.

J. W. ARNOLD,

Manufacturer's Agent, and Broker in

PAPER, TWINE,

And Mill Supplies.

90 Main Street, - - NORTHAMPTON, MASS.

JOB LOTS A SPECIALTY.

MANUFACTURERS OF

BASKETS,

WILLIAMS MFG. CO.

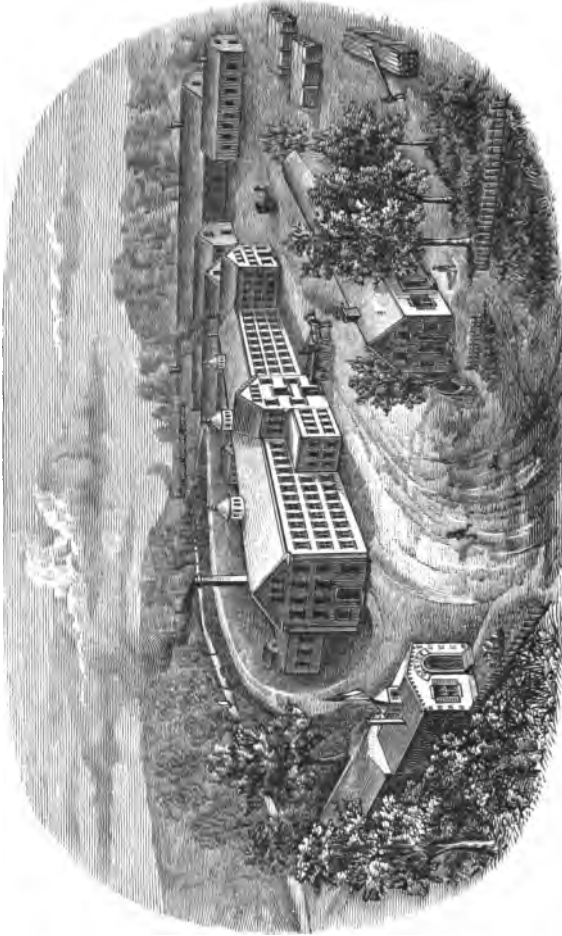

NORTHAMPTON, MASS.

FOOT OF SMITH STREET.

SPLINT, BAMBOO and RATTAN,
Market, Clothes, Corn, and Fruit Baskets.

ESTABLISHED 1850.

L. B. WILLIAMS, Prest.

H. F. WILLIAMS, Treas.

B

NORTHAMPTON EMERY WHEEL CO.

Manufacturers of Premium Solid

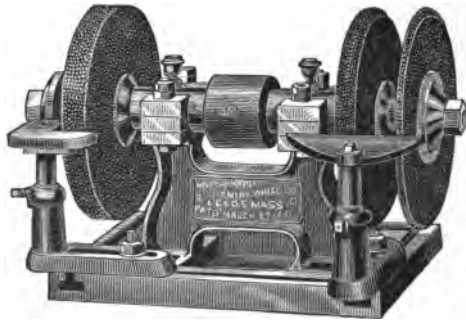

EMERY WHEELS

And Oil Stones,

AND EMERY WHEEL MACHINERY OF ALL KINDS.

Machinery and Wheels furnished for Grinding Planer Knives, Saws, Mouldings, and all other Edge Tools, Drills, Reamers, &c., for Stove Plate, and for general shop use.

Emery Wheels for grinding Brass, Iron, Steel and Glass. Oil Stones for Planer Knives, Shoemakers' use, Mowing Machine Cutters, finishing down iron work, etc.

Customers in ordering Wheels, should give diameter, thickness and size of hole, and state the purpose for which they are to be used.

LEEDS, MASS.

IRA DIMOCK, PREST.

J. L. OTIS, TREAS.

Chicago Office, 199 Lake Street.

NORTHAMPTON + CUTLERY + COMPANY.

MANUFACTURERS OF

TABLE CUTLERY,

Butchers', Carving, and Hunting Knives,

NORTHAMPTON, - MASS.

H. R. HINCKLEY, PRES.

E. E. WOOD, TREAS. AND SUPT.

~~137~~ N. Y. Office,—122 Chambers Street. ~~51~~

THE CRYSTAL EMERY WHEEL CO.

MANUFACTURERS OF PATENT SOLID

Emery and Corundum Wheels,

—AND—

EMERY WHEEL GRINDING MACHINERY,

Hawley Street, - NORTHAMPTON, MASS.

Branch House—42 and 44 South Canal St., Chicago, Ill.

J. MULLIGAN, PRES.

CHAS. E. STEVENS, TREAS. and MANAGER.

FLORENCE MANUFACTURING CO.

MANUFACTURERS OF

Florence Hair Brushes,

TOILET MIRRORS, &c.

Junc. Nonotuck and Pine Streets,

FLORENCE, - MASS.

DAN'L G. LITTLEFIELD, President.

FRANK N. LOOK, Treasurer.

E. N. FOOTE & CO.

MANUFACTURERS AND IMPORTERS OF

BUTTONS

—AND—

ORNAMENTS.

Masonic Street, Cor. Masonic Avenue,

NORTHAMPTON, - MASS.

LUTHER J. WARNER,

MANUFACTURER OF



SEWING SILK,



Tailor's Sewings,

MACHINE TWIST, EMBROIDERY, Etc.

NORTHAMPTON, MASS.

ESTABLISHED 1848.

THE

Damon Narrow Fabric Company,

MANUFACTURERS OF

COTTON TAPES

And Stay Bindings.

PLEASANT STREET and STRONG AVENUE,

NORTHAMPTON, MASS.

E. O. DAMON, PRES.

C. H. PIERCE, TREAS.

HORACE LAMB & CO.

MANUFACTURERS OF

IRON and TINNED WIRE

—FOR—

Brooms, Brushes, Card and Fine Tinned for
Weaving. Also, Annealed and
Bright Wire.

CLARK AVENUE,
NORTHAMPTON, - - MASS.

TIGERITE MFG. CO.**Jewelry, Buttons,**

Pocket Books and Fancy Goods,

Salesrooms, 34 Main Street,
NORTHAMPTON, - MASS.

J. J. HATHAWAY,

MANUFACTURER OF

Hathaway's Octagon Lead Pencils.

83 SOUTH STREET,

P. O. Box, 470.

NORTHAMPTON, MASS.

CHARLES E. CLAPP,

Machinist, Iron Founder and Pattern Maker.

Patterns of all descriptions. All kinds of Iron Castings made at short notice. Sash Weights of all sizes constantly on hand. Also all kinds of Plow and Stove Castings. Cash paid for old Iron. Jobbing promptly attended to.
Orders solicited.

**CORNER PLEASANT AND HOLYOKE STREETS,
NORTHAMPTON.**

**W. HERRICK,
MACHINIST,**

AND MANUFACTURER OF

CIRCULAR SAW MILLS, STEAM ENGINES,

Lathes and Saw Tools,

Mill Gearing, Shafting, Pulleys, Hangers and Bolts.

Repairing done at short notice and in the best manner.
Also, dealer in Water Wheels, Circular Saws, Shingle Mills, Lathe Mills, Planing Machines, Belting and Files. Address

W. HERRICK, - - NORTHAMPTON, MASS.

Shop West side Conn. R. R. Co.'s Freight House.

A. L. WILLISTON,
Agent and Treas.

Incorporated 1846.

F. H. STODDARD,
Secretary.

GREENVILLE MANUFACTURING COMPANY,
Sheetings and Drills,

Junction Nonotuck and River Streets.

FLORENCE, - - - - - MASS.

CLARENCE E. BROWN,
Silver and Nickel Plater.

Old Knives, Forks, Spoons, Castors, &c., Refinished
Before Plating.

Silver Deposited by Weight, and Reasonable Satisfaction Guaranteed. Old
Silver Ware Cleaned, and New Silver Ware Furnished.

41 CENTER STREET,
NORTHAMPTON, - MASS.

A. KINGSBURY & SON,

MANUFACTURERS OF

PAPER BOXES

OF ALL DESCRIPTIONS.

Double and Single End Shipping Tags, Cards, &c.

All Work done Promptly and in the Best Manner.

Factories at SOUTH COVENTRY, and ROCKVILLE, CT.

38 Main Street, Union Block, NORTHAMPTON, MASS.

Orders by Telephone promptly attended to.

ASA SMITH, Prest.

T. W. PEARSALL, Treas.

Connecticut River Lumber Co.
MANUFACTURERS OF
Lath, Shingles,
SPRUCE LUMBER AND SPRUCE PILES.

— MILLS AT —

HARTFORD, CONN.

HOLYOKE, MASS.

MT. TOM, MASS.

ESTABLISHED, 1871.

✧ **ALBERT KING,** ✧

MANUFACTURER OF

NITRATE OF IRON,

AND DEALER IN

All Kinds of Acids.

Office, Myrtle Street,

- - - FLORENCE, MASS.

SUBSCRIBE FOR
PRICE, LEE & CO.'S
NEW ENGLAND RAILWAY GUIDE

ISSUED MONTHLY.

Sent to any address for One Dollar per year.

J. C. HAMMOND,
ATTORNEY

—AND—

Counselor at Law.

Office over First National Bank, Main Street,

NORTHAMPTON, - - - MASS.

PARSONS & CROSSLEY,
ATTORNEYS AT LAW,

52 MAIN STREET,

NORTHAMPTON, MASS.

ENOS PARSONS,
Justice of the Peace and Notary Public.

A. T. CROSSLEY.

T. G. SPAULDING,
ATTORNEY AND COUNSELOR AT LAW,

Justice of the Peace and Notary Public.

Office over Northampton Institution for Savings, Main St.,

NORTHAMPTON.

CHARLES N. CLARK,
Attorney and Counselor at Law,
AND NOTARY PUBLIC.

Over Northampton National Bank, 101 Main Street,
NORTHAMPTON, MASS.

JOHN B. O'DONNELL,
Attorney and Counselor at Law

POST OFFICE ADDRESS,

Opera House Block, 120 Main, cor South Street,
NORTHAMPTON, - - - - MASS.

RESIDENCE, FLORENCE.

OFFICE HOURS.—From 8.30 A. M. to 5.20 P. M. Attends to business from 6.30
to 9 P. M., at his office, Beacon Street, Florence, Mass.

HILL & WAINWRIGHT,
Attorneys and Counselors at Law.

Office over Northampton Institution for Savings,
Main Street, - - - NORTHAMPTON, MASS.
Easthampton Office, 11 Prospect St.

DAVID HILL.

J. ARTHUR WAINWRIGHT.

DR. L. B. PARKHURST,
HOMŒOPATHIST.

Office of the late Dr. Harding, 20 Pleasant St.

Office hours, 2 to 4 P. M., and after 7 P. M.

Specialty: Diseases peculiar to Women.

DR. W. H. JONES,
DENTIST.

Clarke Block, 58 Main Street,

NORTHAMPTON, MASS.

R. D. BROWN,
DENTIST.



Office, Davis Block, Main Street,

Residence, Center Street.

FLORENCE, MASS.

G. W. CRITTENDEN,
DENTIST.

McCallum's Block, 114 Main Street.

NORTHAMPTON, MASS.

DR. J. Q. STONE,
DENTIST.

Artificial Teeth, best, \$10.00. Gas \$1.00. Gold Fillings, \$1.00 up.
Silver Fillings, 50 Cents up. Extracting, 25 Cents.

Office, Union Block, opposite First National Bank, 38 Main St.

NORTHAMPTON, MASS.

Hampshire Mutual Fire Insurance Co

INCORPORATED 1830.

Insures Dwelling, Barns and Contents Only

Never paid less than 40 per cent. Dividend.

OLIVER WALKER, Secretary and Treasurer.

GEO. W. HUBBARD, President.

52 Main St., - - - NORTHAMPTON.

OLIVER WALKER.

GENERAL INSURANCE AGENT.

Fire, Life and Accident.

Represents over \$100,000,000 Assets.

REAL ESTATE AND FOREIGN TICKET AGENT.

Kirkland's Block, 52 Main Street,

NORTHAMPTON, - - - MASS.

J. M. KELLOGG,

FARM AGENCY,

And Dealer in all kinds of

Real Estate.

HOUSES RENTED AND RENTS COLLECTED.

149 Main Street over W. F. Prindle's Stove Store.

NORTHAMPTON, - - - MASS.

ESTABLISHED 1852.

Chauncey H. Pierce,

INSURANCE AND REAL ESTATE AGENT,

NOTARY PUBLIC AND JUSTICE OF THE PEACE.

OFFICES—2nd Floor Building of Northampton Institution for Savings, Near Court House.

NORTHAMPTON, MASS.

W. HOTCHKISS,

ARTIST IN

Oil, Crayon, Ink, and Water Colors.

Portraits and Landscapes in Oil a Specialty.

PICTURES OF DECEASED PERSONS COPIED IN OIL, CRAYON OR INK.

Union Block, 38 Main St., NORTHAMPTON.

*NEW TYPE!**NEW STYLES!**NEW PRICES!***STAR PRINTING HOUSE.*****C. A. SNOW,*****Job Printing, Lithography.**

Labels of all kinds at Low Rates.

Cor. Main and Hawley Street, - NORTHAMPTON.

ADOLPHE MENARD,

Justice of the Peace, and Railroad agent for all parts of

Canada and the West.**Agent for Allen Line of Steamers.**Passengers will **SAVE MONEY** by buying Tickets at this Office. Agent for Le Jean Baptiste, Menard, Belisle & Co., publishers' office,**98 MAIN STREET,****NORTHAMPTON, - - - - - MASS.****CLARK'S INDELIBLE PENCIL CO.**

Established 1859, Manufacture



CLARK'S PATENT INDELIBLE PENCIL, also
CLARK'S STANDARD INDELIBLE INK,
AND PEN HOLDER.

These preparations have no superior in the market for marking Linen, Cotton, Silk and Fabrics. We call special attention to *Agents and Traveling Men* to the special offers we make, and solicit a call when in town.

Office and Manufactory, No. 6 Strong Avenue.**P. O. Box, 141.****NORTHAMPTON, MASS.**

HAMPSHIRE CO. MUSIC STORE!

124 Main Street, NORTHAMPTON, MASS.

IS THE HEADQUARTERS FOR

Sheet Music Books,

AND ALL KINDS OF MUSICAL MERCHANDISE.

We represent the Leading Houses in New York and Boston, and any article can be procured at three days' notice.

Pianos and Organs

ALWAYS ON HAND, FOR SALE AND TO RENT.

BRASS AND WOODEN WIND INSTRUMENTS

Of all descriptions, and at prices to suit any purchaser.

☛ OPERA HOUSE TICKET AGENCY. ☚

CONNECTED BY TELEPHONE.

GEO. S. WHITBECK.

LOUIS B. GRAVES.

JOHN PARNELL,

(WALTER J. FORRESTALL, MANAGER.)



UNDERTAKER,

Is now ready to attend to and furnish all articles necessary for funerals that parties may require. A full line of

Caskets, Coffins, Habits, Robes, Trimmings, &c.

CONSTANTLY ON HAND.

All Orders Promptly Attended to.

Warerooms—Strong Avenue., opposite N. H. & N. Passenger Depot,
NORTHAMPTON, MASS.

LINCOLN & BELL,

DEALERS IN



Dry Goods and Carpets,

—ALSO, AN—

Art Department,

Filled with choicest Engravings, Etchings, Photographures, Photographs; Water Colors, and other
Art Goods

70 MAIN,

NORTHAMPTON, MASS,

A. McCALLUM,

Cash Dry Goods Store,

116 Main Street, opp. Mansion House,
NORTHAMPTON, - - MASS.

BOSTON STORE!

The Largest and most Complete Stock of

DRY GOODS,

Fancy Goods,

CARPETS, OIL CLOTHS, &c.

In Town. All Goods sold at the Lowest Market Prices.

ONE PRICE ONLY.

FEARING & EVERETT,

86 Main St., Northampton, Mass.

J. E. LAMBIE & CO.

—CASH DEALERS IN—

DRY GOODS,

Rich Dress Goods, Silks and Fancy Goods,
Dress Trimmings, Buttons, Hosiery,
Corsets, Gloves, Ladies' and
Gents' Underwear, &c.

64 MAIN STREET,

NORTHAMPTON, - - - MASS.

J. E. LAMBIE.

D

F. J. KELLOGG.

CROCKERY,
China, Glass Ware, Silver Plated Ware, and
PAPER HANGINGS,

—IN FULL VARIETY, AT—

WM. DEARDEN'S 32 Main Street.

Tea Trays, Tea Pots, Cutlery, Feather Dusters, Bird Cages,
 Lamps, Lanterns, Chandeliers, and Fancy Goods.

Everything the Latest and Best and at Bottom prices
 always. Wholesale and Retail.

WM. DEARDEN.

✧ **M. C. HOWARD,** ✧

— DEALER IN —

PAPER



HANGINGS,

Paints, Oils, Varnishes, &c.

House and Sign Painter and Grainer.

PLAIN AND DECORATIVE PAPER HANGER.

Shop, West Center St., - - FLORENCE, MASS.

FOR LOWEST PRICES IN STYLISH
PAPER HANGINGS,
Floor Oil Cloths,

Window Curtains, Stylish Crockery, Plain and Fancy
 Flower Pots, Rogers' Silver Plated Ware,

— CALL AT —

Mrs. A. M. SKILTON'S,
 15 Pleasant Street, - Northampton, Mass.

THE PLACE TO BUY

Millinery and Fancy Goods,
WORSTEDS, PATTERNS and EMBROIDERIES,
C. H. DICKINSON,

88 Main Street, - - Northampton, Mass.

A. H. STOCKER & CO.

Hatters and Furnishers

Good Goods and Reliable Prices.



White and Fancy Shirts, Underwear
 and Hosiery, Neck Wear, Collars,
 and Cuffs, Trunks and Bags,
 Ladies' and Misses' Furs,
 Buffalo, Wolf and Lap
 Robes, Men's Seal and
 Otter Caps and
 Gloves, Horse
 Blankets.

SEAL SACKS A SPECIALTY.

96 MAIN STREET,

NORTHAMPTON, - MASS.

SMITH & PRINDLE,
 MERCHANT TAILORS,
 Men's Youths' and Boys'
 ⇒ꞤCLOTHINGꞤ⇐
 GENTS' FURNISHING GOODS, &c.
 68 MAIN STREET,
 NORTHAMPTON, ✧ ✧ MASS.

CHARLES SMITH.

J. H. PRINDLE.

COPELAND'S BAZAAR.
Emporium of Fashion
 Ladies' Underwear, Sacques, &c. a Specialty.

Stamping in every Variety, Canvasses, Felts, Plushes, Satins,
 Sateens, Fringes, Crewels, Worsteds, Germantowns.
 Flosses, and every Variety of Embroidering Ma-
 terials. Corsets, Gloves, Ties, Scarfs, Laces,
 Fans, Baskets, Ribbons, and an un-
 limited assortment of Fancy
 Goods and Notions.

Hair goods in Stock, and all varieties made to order.

Agency for Malden Dye House. Kid Gloves Cleaned, ten cents per pair.
Infants Wardrobes complete and Materials for same

Sewing Machines of every desirable style, and all Machines repaired,

HARPER'S BAZAAR, PAPER PATTERNS.

COOK'S MARBLE BLOCK NORTHAMPTON, MASS.
 72 Main Street,

M. M. FRENCH & CO.,

CASH DEALERS IN

READY-MADE CLOTHING,

GENTLEMEN'S FURNISHING GOODS,

Hats, Caps, Trunks, Valises, Umbrellas, &c.

82 Main Street, Northampton, Mass.

FLORENCE CLOTHING STORE!

Ready Made Clothing, Gents Furnishing Goods, Hats,
Trunks and Traveling Bags.

H. K. PARSONS,
PROPRIETOR.

C. O. PARSONS,
MANAGER.

— ALSO DEALER IN —

→‡ Coal, Wood, Flour, Hay, ‡←

And all kinds of Grain and Feed.

Maple cor. Main Street,

FLORENCE, MASS.

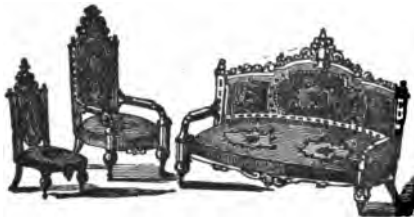

R. W. & J. R. SACKETT,

Wholesale and Retail

FURNITURE

AND

COFFIN WAREROOMS.

Mattresses, Feathers, Husks, Excelsior, Curled Hair, Comforters, Pillows, Crockery, Glass, Wooden Ware, &c.

No. 2, 4 and 6 King Street.

NORTHAMPTON, MASS.

ESTABLISHED 1873

PRICE, LEE & CO.,

DIRECTORY PUBLISHERS,

YALE BANK BUILDING,
Corner State and Chapel Streets, }

NEW HAVEN, CT.

The following Directories published annually at this office:

New Haven, Bridgeport, Norwich, Waterbury, Meriden, Bristol, Plainville,
Southington, Derby, Winsted and Torrington, in Ct.; Holyoke, Northampton,
Easthampton, Fitchburg, in Mass.

❖ **D. E. HOXIE,** ❖

WATCHMAKER AND JEWELER

Clarke Block, 60 Main Street,
NORTHAMPTON, - MASS.

Watches set and regulated by Transit observations of the sun,
FREE OF CHARGE.

D. E. HOXIE,
Hillside Small Fruit Nursery

Buy Plants, Vines, &c., near home! Save Express Charges! Get Fresh Goods!

STRAW
RASPB
BLACK
GOOSE

} **BERRIES.**

GRAPE VINES.
CURREANTS,
QUINCES,
ASPARAGUS, &c.

Office: Clarke Block, 60 Main Street, NORTHAMPTON, MASS.

Grounds at Roberts Meadow.

E. A. ROBERTS,
JEWELER.



AMERICAN WATCHES A SPECIALTY.

Fine Watch Repairing done at Short Notice.

54 MAIN STREET, - NORTHAMPTON, MASS.

Northampton Boot and Shoe Store,

J. C. PHELPS, Proprietor.

Dealer in all kinds of

Boots, Shoes and Rubbers.

☞ TERMS CASH. ☛

No. 84 MAIN STREET,

NORTHAMPTON, MASS.



❖ **D. J. WRIGHT,** ❖

DEALER IN

AGRICULTURAL TOOLS,

Grass and Garden Seeds,

GROCERIES OF ALL KINDS.

A good assortment of Corn Shellers and Feed Cutters on hand.

Union Block, 36 Main St., - NORTHAMPTON, MASS.

❖ **J. M. SKIFF,** ❖

DEALER IN

Watches, Clocks, Jewelry,

SPECTACLES, EYE GLASSES, &c.

Watch Repairing a Specialty. Longer experience and more practice than any other in the County.

119 Main St., two doors east of Post Office,

NORTHAMPTON, - MASS.

A. G. CARLEY,

Books, Stationery and News.

Artist Materials, Archery, Lawn Tennis, Croquet, &c.

SCHOOL BOOKS AND SCHOOL SUPPLIES.

115 Main Street,

NORTHAMPTON, MASS.

JOSEPH MARSH,

DEALER IN

Books, Stationery, Pictures, Frames.

Music, Periodicals, Daily and Weekly Papers.

48 Main Street, - NORTHAMPTON, MASS.

G. H. WALKER & CO.,

(Successors to Parsons & Wells), DEALERS IN

Drugs, Medicines, Chemicals, Paints,
OILS, VARNISHES,

PAINTERS' AND ARTISTS' MATERIALS.

PRESCRIPTIONS A SPECIALTY.

CHOICE IMPORTED FANCY GOODS.

— CAREFULLY SELECTED —

BRANDIES, WINES AND ALES,

FOR MEDICINAL PURPOSES.

Choice Family Groceries.

90 Main Street, NORTHAMPTON, MASS.

O. EDWARDS & CO.,

— DEALERS IN

DRUGS, PAINTS, OILS,
And Groceries.

100 Main Street, NORTHAMPTON, MASS.

OSCAR EDWARDS.

L. S. DAVIS.

F. A. & W. E. BARNES,

Druggists,  **Pharmacists.**

LITTLE'S BLOCK, MAIN STREET,

FLORENCE, MASS.



Boots and Shoes

In great variety, from the best quality down. Prices guaranteed the lowest to be found

J. KNOWLTON,
Todd's Block, 119 Main Street,
NORTHAMPTON.
Two doors from P. O.

DON'T FORGET

When you are in want of

BOOTS

— AND —

SHOES,

— THAT —

S. D. HADLEY & CO.

Have a Large Stock in all the Leading Styles, and are selling the same at the
LOWEST CASH PRICES.

REMEMBER THE PLACE.

S. D. HADLEY & CO.,

98 Main Street, NORTHAMPTON, MASS.

P. P. HOSMER,

MANUFACTURER OF AND DEALER IN LADIES' AND GENTS'

FINE BOOTS AND SHOES.

*Difficult feet fitted and Satisfaction Guaranteed. Boots, Shoes
and Rubbers repaired. All work warranted.*

189 Main Street, opposite Library, Northampton, Mass.

E

M. L. & M. W. GRAVES,

WHOLESALE AND RETAIL DEALERS IN

Flour, Grain, Meal and Feed,

Lime, Cement, Fire Brick and Clay,

Baled Hay and Straw.

— AGENTS FOR —

PILLSBURY'S CELEBRATED HAXALL FLOUR.

And GRAVES' BROS. BRILLIANT ST. LOUIS FLOUR.

RAILROAD STEAM MILLS,

Cor. Main and Market Street, **NORTHAMPTON, MASS.**

CONNECTED BY TELEPHONE.



LYMAN & SHIPMAN,

Manufacturers and Wholesale Dealers in

Confectionery, Fancy Pastry

Crackers, Cigars, &c.

Carr's Block, 153 Main Street, Northampton.

J. W. MADISON,

Baker of Bread and Pastry

Also, Dealer in **CONFECTIONERY, &c.**

COR. MAIN AND MAPLE ST., FLORENCE.

G. L. LOOMIS & CO.,

(Successors to DEWEY & LOOMIS,)

WHOLESALE AND RETAIL DEALERS IN

Groceries, Provisions, Fruit, &c.

Are also Hampshire County Agents for

BOSTON BUCKBOARD CO, of New Haven Ct. J. L. CLARK & SON,
Oshkosh, Wis., and the CORTLAND WAGON CO. of Cortland,
N. Y. Also Lumber Wagons made by E. D. CLAPP
WAGON CO. of Auburn, N. Y.

Which enables them to supply almost any style of fine, light Carriage or Business Wagon that may be needed. The only place in the County where from thirty to fifty vehicles are kept in stock. Sold at the lowest possible prices for first-class work.

CONNECTED BY TELEPHONE.

No. 8 Pleasant Street, - - - NORTHAMPTON.

J. M. TOWNE & SONS,

DEALERS IN CHOICE

Groceries, Provisions, *AND CANNED GOODS.*

— ALSO, —

Wooden Ware, Confectionery,

CIGARS, TOBACCO, &c.

Wright's Block, 201 Main Street,

NORTHAMPTON, . . . MASS.

EDWARDS BROS.,

Dealers in the Finest Qualities of Staple and Fancy

GROCERIES

Canned Goods,

Teas, Coffees, Pure Spices,

FISH, PROVISIONS, &c.

Our Teas and Coffees will give you Perfect Satisfaction.

133 Main Street, Mansion House Block,

NORTHAMPTON, MASS.

✧ **E. A. BROOKS,** ✧

GROCCER,

AND DEALER IN

Flour, Provisions, &c.

14 Main Street, - NORTHAMPTON, MASS.

T. RUST & SONS,

DEALERS IN CHOICE

FAMILY GROCERIES, PROVISIONS,

Crockery, Glass Ware, Wooden Ware, Hardware,
Fruits, Vegetables, &c.

OFFICE OF THE NORTHAMPTON ICE COMPANY.

163 Main St., Rust's Block, opp. Town Hall,

THEODORE RUST.
CHARLES RUST.
ALVIN RUST. }

NORTHAMPTON, MASS.

R. LEWIS & SON,
DEALERS IN

Flour, Salt, Tea, Groceries

Tobacco and Provisions of all Kinds.

ALL KINDS OF FRUIT IN ITS SEASON.

193 MAIN STREET, NORTHAMPTON.

E. S. ROSS,

General Dealer in all kinds of Staple and Fancy

Dry Goods, Groceries, Provisions,

CROCKERY, BOOTS and SHOES.

FLOUR, GRAIN and MEAL.

☞ All kinds of Produce Bought and Sold ☞

NONOTUCK STREET, - - LEEDS, MASS.

DONOVAN & PURCELL,

— GENERAL DEALERS IN —

Groceries, Provisions,

CROCKERY, BOOTS and SHOES,

Flour, Grain and Feed.

ALL KINDS OF PRODUCE BOUGHT AND SOLD.

MAIN STREET, - - - LEEDS, MASS.

FELIX VADEAU,

General Dealer in all kinds of Staple and Fancy

Dry Goods, Groceries, Provisions

CROCKERY, BOOTS AND SHOES,

FLOUR, GRAIN AND MEAL.

All kinds of Produce Bought and Sold.

Bridge, cor. Water Street, - LEEDS, MASS.

JACKSON'S MARKET,

M. W. JACKSON, Proprietor.

Where can always be found a Large Stock of

POULTRY, FRESH, SALT



AND SMOKED MEATS,

Selected from the best the market affords Also, FRESH VEGETABLES, GAME, VENISON, etc., in their season. Cash paid for Hides, Calf and Wool Skins.

126 Main Street, cor. South Street, - NORTHAMPTON, MASS.



THOMAS RAFTRY,

Wholesale and Retail Dealer in

Pork, Lard, Ham

AND SAUSAGES.

FRESH AND SALT MEATS, POULTRY, GAME, VEGETABLES, &c.

Cash paid for Hides, Calf and Wool Skins.

7 Pleasant St., Northampton

✦ E. COUTURE, ✦

BAKER and GROCER.

BAKER OF BREAD, CAKE AND PASTRY.

Dealer in a Choice Line of GROCERIES,

10 MARKET ST., NORTHAMPTON, MASS.

The Crawford Range!

••• LEE & DAY, •••

Plumbers, Steam and Gas Fitters.

*STOVES, RANGES, HOT-AIR FURNACES,
TIN ROOFING, GUTTERS, &c,*

PERSONAL ATTENTION GIVEN TO REPAIRS.

171 Main Street, - NORTHAMPTON, MASS.

S. W. LEE.

W. H. DAY.

The Walker Furnace!

W. F. PRINDLE,

Plumber, Steam and Gas Fitter,

— AND DEALER IN —

Stoves, Hot-Air Furnaces,

MARBLE MANTELS, GRATES, GAS FIXTURES,
DRAIN PIPE, &c.

149 Main St., opp. Town Hall, - NORTHAMPTON, MASS.

FRANCIS W. FISH,

Cabinet Maker & Furniture Repairer.

All New and Old Work will receive Prompt Attention.

Clothes Wringers of all kinds Repaired. Agent for

W. W. Wayman's Patent Weather Strips.

REAR JONES' BLOCK, COURT STREET,

NORTHAMPTON, - - - MASS.

EAMES & SPRAGUE,
Plumbers, Gas Fitters

AND DEALERS IN

Stoves, Hot-Air Furnaces,
 Ranges, Pumps, Tin, Copper and
 Sheet Iron Ware.

NO. 24 MAIN ST., DICKINSON'S BLOCK,
 NORTHAMPTON, - MASS.

G. D. EAMES.

S. D. SPRAGUE.

SAMUEL WILDER,

DEALER IN

FURNACES, RANGES,
And STOVES of all Kinds.



We call special attention to the

New Model Range,

For which we are Agents for Northampton, Florence and vicinity. We keep a general line of

BUILDERS' HARDWARE,

CUTLERY, &c.

Particular Attention given to
 Roofing, Plumbing and
 General Jobbing.

Maple Street,

FLORENCE, MASS.

KIMBALL & CARY,

DEALERS IN

ANTHRACITE AND BITUMINOUS



ALL RAIL COAL A SPECIALTY.

Main, cor. Hawley Street, - NORTHAMPTON, MASS.

W. D. CLAPP,

— DEALER IN —

WOOD and COAL

Lackawanna, Lehigh, Lykens Valley, Franklin Coal, of all sizes, by the Ton, Car-load or Cargo, at the Lowest Prices.

Office in old Passenger Depot, first door south C. R. R. Depot,

NORTHAMPTON, MASS.

NONOTUCK HOUSE!

Cor. Pleasant and Pearl Streets, Northampton, Mass.

ONE BLOCK FROM R. R. DEPOT.

TERMS, \$1.50 PER DAY.

Permanent Board at Reasonable Rates.

Wine Room supplied with the best of Wines, Liquors and Cigars.

Livery and Feeding Stable connected with the House.

E. O. DALRYMPLE, Proprietor.

HENRY A. WRIGHT,

WHOLESALE AND RETAIL DEALER IN

Soft and Kindling Wood.

PARTICULAR ATTENTION GIVEN TO SHIPPING
WOOD BY THE CAR-LOAD.

Yard at Conn. River Lumber Co.'s Mill, - - MT. TOM.

RESIDENCE,—41 SOUTH STREET, NORTHAMPTON.

NORWOOD ICE CO.

(THE NEW COMPANY.)

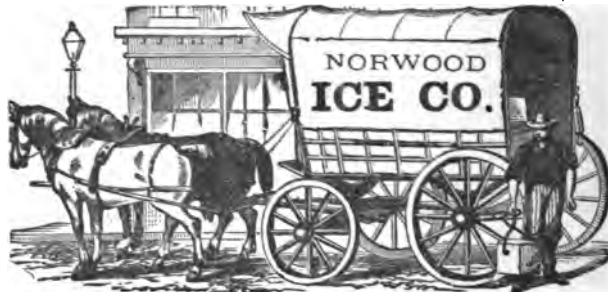

Have made an artificial pond, covering from 5 to 6 acres, and of fourteen million gallons capacity, supplied with pure spring water, and will furnish Ice at the **LOWEST RATES**, on the same routes where Ice Teams are usually run.

Ice washed at Ice Houses, weighed and put into refrigerators, carefully and without extra charge.

By strict attention to the Ice Business, and employing none but competent and obliging men, and serving customers with promptness and regularity, I hope to meet with a continuance of the liberal patronage heretofore received.

OFFICE IN OPERA HOUSE BLOCK, NORTHAMPTON.

ANSEL WRIGHT, Manager.

EDWARD P. HALL & CO.,
DEALERS IN

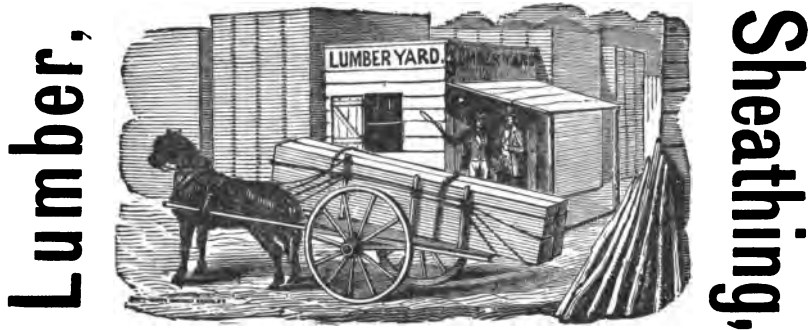

Flooring, Box and Finish Boards,
Shingles, Lath, Clapboards, &c., &c.

DIMENSION TIMBER DELIVERED AT SHORT NOTICE.

Yard on Gothic St., rear Gazette Office, Northampton, Mass.

☞ All Orders filled with dispatch.

H. A. WRIGHT,

— DEALER IN —

LUMBER!

Michigan Pine of all kinds, Michigan Pine
Clapboards, Michigan Pine Shingles, and
Cedar Shingles, Spruce and Pine Floor-
ing, Mouldings of all Patterns, To-
bacco Cases, &c.

Office near N. H. & N. B. R. Freight Depot,

NORTHAMPTON, - MASS.

C. N. HARLOW & CO.,
CARPENTERS
And Joiners.

All Building and Jobbing will receive attention.

Estimates furnished when desired.

Shop, Kirkland Ave., - NORTHAMPTON.

W. F. PRATT & SON,
ARCHITECTS.

Plans, Elevations, Specifications, and full sized Working Drawings prepared for every description of building on reasonable terms.

105 MAIN STREET, - NORTHAMPTON, MASS.

P. O. BOX, 746.

JOSEPH HEBERT,
Carpenter, Contractor and Builder.

Estimates furnished when desired. Jobbing of all kinds promptly attended to. Satisfaction guaranteed.

SHOP, GOTHIC ST., NEAR COURT ST.,
NORTHAMPTON, MASS.

GEO. D. JEWETT,

WHOLESALE DEALER IN

Lumber and Shingles

OFFICE, 90 MAIN STREET,
NORTHAMPTON, - - - - MASS.

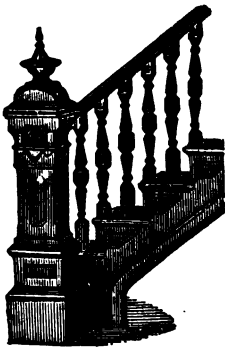

WILLIAM C. POMEROY,

Stair Building, Pattern Maker,

Band Sawing, Planing,

Moulding and Jobbing of all descriptions.

CENTER STREET.

NORTHAMPTON, - MASS.

JOHN HUXLEY,

Carpenter and Builder.

Contracts taken for the construction of build-
ings. Jobbing done at short notice.

Arlington Street, - - NORTHAMPTON, MASS.

HENRY GEROU,

Carpenter and Builder.

Estimates furnished when desired. Jobbing
of all kinds promptly attended to.
Satisfaction guaranteed.

WATER STREET, - - LEEDS, MASS.

SMITH & LIVERMORE,
Carpenters, Builders,
CONTRACTORS,
— AND —
Lumber Dealers.

We are ready at all times to erect Buildings.
Jobbing of all kinds promptly attended to.
Estimates furnished at short notice.

Shop, Center Street, - - NORTHAMPTON.

HENRY M. SMITH.

ORRIN E. LIVERMORE.

C. S. CROUCH,
CONTRACTOR AND BUILDER.

26 PLEASANT STREET,
NORTHAMPTON, - MASS.

B. HEBERT & SON,
Carpenters and Builders.

Contracts taken for the construction of Build-
ings. Jobbing done at short notice.

Shop, Bridge Street, opp. Cemetery, NORTHAMPTON.

BROWN & BAILEY,
Masons, Contractors,
— AND —
BUILDERS.

Contracts taken for Buildings of every description. We furnish Building Materials of all kinds. All jobbing will receive attention.

Cor. Gothic and Allen Street, . NORTHAMPTON.

JERE BROWN, Residence 41 Gothic, cor. Allen Street.

WILLIAM A. BAILEY, Residence Allen Street.

JOHN L. MATHER,
Stone and Brick Mason,
Builder and Contractor.

PERSONAL ATTENTION GIVEN TO ALL JOBS.

Stone Work of all kinds will receive prompt attention.

Residence 77 Elm Street, .

NORTHAMPTON.

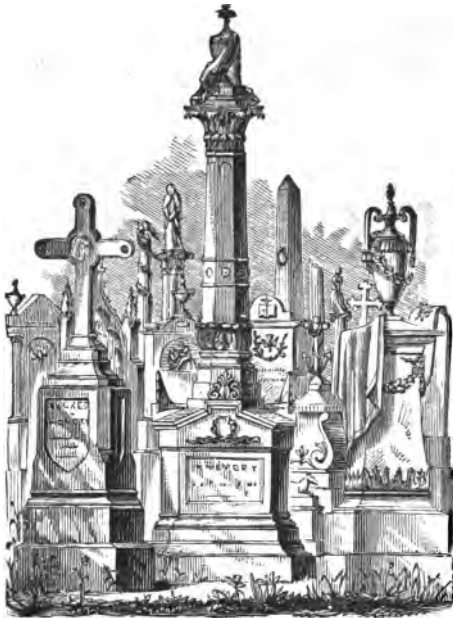

HAMPSHIRE
MARBLE WORKS,

C. W. Kinney, Proprietor.

Manufacturer of

GRANITE and MARBLE
Cemetery Work,

And Dealer in

Mantels, Shelves and
Soap Stone.

Cor. Court and King St.,

NORTHAMPTON,
MASS.

LANDY BROS. & CO.,

PROPRIETORS

Granite Stone Quarry

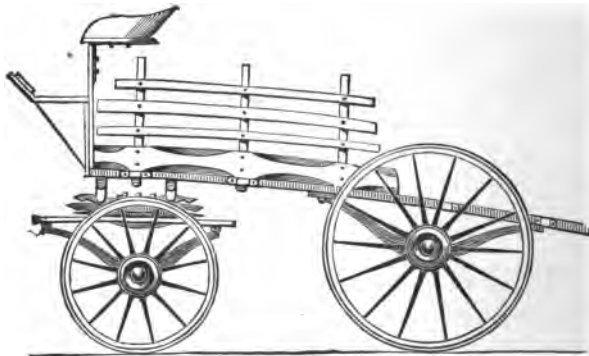

For building purposes. Heavy Trucking a specialty. Sand
for filling and grading. Bank located on Prospect
Street, Northampton. Orders solicited.

Office, Nonotuck Street,

FLORENCE, MASS.

S. L. PARSONS & SON,
Graders and Truckmen.

A FINE SAND BANK

For building purposes.

☛ ALSO, GRADING. ☚

Office, 12 and 14 West Street, **NORTHAMPTON, MASS.**

✧ JOSEPH SALOIS, ✧

TEAMSTER, TRUCKMAN,
AND JOBBER.

All Work in my line will receive Prompt Attention.

Residence rear 33 Pleasant St., near R. R. crossing,

NORTHAMPTON, - - - MASS.

E. B. HOWES,

Truckman and Piano Mover.

All kinds of jobbing promptly attended to.

Orders left at F. I. Washburn's, 122 Main St., Northampton.

Residence, Maple St., Florence, Mass.

HENRY S. BUCKNAM, JOBBER

— AND —

Piano Mover.

Trucking, Moving, and all kinds of Teaming carefully attended to. Pianos packed and delivered at the depot, from any part of the town, with care and dispatch. Orders left at Whitbeck's Music Store.

Opera House Block, 124 Main Street.

Residence 18 Cherry St., NORTHAMPTON.

GEO. F. DICKINSON,

Baggage Express

Order Slates at

GEO. H. WALKER & Co.'s. CLARK & PARSONS.

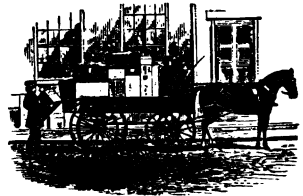

RESIDENCE. PROSPECT COR. SPRING STREET,

NORTHAMPTON, - - - - MASS.

JOSEPH MURRAY, BUILDING MOVER.

Contracts taken for moving and raising both BRICK and WOOD BUILDINGS. Also, STONE WORK for CELLARS.

TRUCKING

OF ALL KINDS. SPECIAL ATTENTION GIVEN TO MOVING HOUSE-HOLD GOODS, &c. ORDERS SOLICITED.

Residence, King Street, - Northampton, Mass.



R. B. DAVIS & CO.,

MANUFACTURERS OF

CARRIAGES, BUGGIES

Wagons, Sleighs, Sleds, &c.

CONCORD BUGGIES A SPECIALTY.

Also, Repairing, Painting, and Trimming. All work warranted.

Shop, 11 South Street, NORTHAMPTON.

R. B. DAVIS.

GEO. DAVIS.

GEORGE S. PHELPS,

Manufacturer and Repairer of

Carriages, Wagons and Sleighs.

All kinds of vehicles made or repaired in best manner.

7 Masonic Street, - - - NORTHAMPTON.

S. C. ROSE,

Carriage Trimming & Repairing.

At Geo. Phelps' Shop, Masonic Street, NORTHAMPTON.

ZENAS FIELD,

BUILDING MOVER

— AND —

TRUCKMAN.

Buildings Moved and Raised. Special attention given to jobbing,
especially moving household goods.

Foot of Pleasant Street, - NORTHAMPTON, MASS.

SUBSCRIBE FOR PRICE, LEE & CO.'S

New England Railway Guide.

ISSUED MONTHLY.

Sent to any address for One Dollar per year.

GILBERT ROSEBUSH,
CARRIAGE MAKER

And Repairer.

FIRST-CLASS WORK AT LOWEST PRICES.

Main St., opp. Masonic St., NORTHAMPTON.

JOHN C. JAGER,

Manufacturer of and Dealer in

CARRIAGES, WAGONS and SLEIGHS

Of all Grades and Prices.

REPAIRING, PAINTING AND TRIMMING
 DONE IN A FIRST-CLASS MANNER.

Maple St., near R. R. Crossing,
 FLORENCE, - MASS.



CHAS. L. RICHARDSON,
Blacksmith, Horse Shoer,

AND GENERAL JOBBER.

All Horse Shoeing and General Jobbing will
 receive prompt attention.

Shop Court Street, rear W. L. Smith & Co.'s
 Furniture Store,

NORTHAMPTON.



B. F. RICE,

Blacksmith and Horse Shoer.

ALSO, OWNER OF

Stallion, Smuggler 2d.

FOOT OF FRUIT STREET,

Northampton, - Mass.



MANSION HOUSE



RODNEY BROWN, Proprietor.

129 Main St., - NORTHAMPTON, MASS.

Most centrally located for business. Unexceptionable Table. The Commercial Hotel of the Town. First-class Billiard Room and Livery Stable connected with House. Horse Cars pass the door.

HAMPSHIRE HOUSE.

GEO. R. WHIPPLE, Proprietor.

Cor. Strong Ave. and Main Street, opp. N. H. & N. Depot,

NORTHAMPTON.

Commercial Travelers will find this House centrally located, near both Railroad Depots.

Horse Cars pass the door.

JOSEPH L. LORD,
BEDS AND MATTRESSES RENOVATED.

NEW MATTRESSES MADE TO ORDER.
MATTRESSES AND FEATHERS FOR SALE.
 No. 1341-2 MAIN STREET,
NORTHAMPTON, - - - MASS.

Hampshire Steam Dye House

F. W. KAISER, Proprietor.
 Ladies' and Gents' Clothes Cleaned, Colored
 And Repaired.
 KID GLOVES A SPECIALTY.
Second Hand Clothes Bought and Sold.
 No. 7 State Street, - - - **NORTHAMPTON, MASS.**



JOHN TYLER,
House and Carriage Painter,
AND PAPER HANGER.
ALSO, DEALER IN
SASH, DOORS AND BLINDS.
 134 Main Street, **NORTHAMPTON, MASS.**

G. W. ARMS,
→ † LAUNDRY † ←

Laundry Work done in first-class manner. Goods
 called for and delivered free of charge. All
 goods left at E. P. Copeland's Store, 72
 Main Street, will receive prompt
 attention. Lace Curtains
 and Shades a specialty.

Laundry, 29 Bridge Street, - - - NORTHAMPTON, MASS.

DICKINSON & POMEROY,

Hack,



Livery,

Boarding AND Feed Stables.

Carriages for Opera House, parties, and calling jobs, and to all trains. Single teams and saddle horses at reasonable rates. Boarding a specialty. Accommodations for feeding in shed. Orders by telephone promptly attended to, and satisfaction guaranteed.

Center St., rear Northampton Nat'l Bank, NORTHAMPTON.

Mansion House Livery Stable!

JOHN L. DRAPER, Proprietor.



Good teams of all descriptions can be obtained at reasonable rates. Careful drivers furnished if desired

MAIN STREET, REAR CARR' BLOCK,

NORTHAMPTON, . . . MASS.

**E. T. WOOD, Jr.,
Boarding, Feeding,**

— AND —



LIVERY STABLE.

Opp. Conn. River Depot,
NORTHAMPTON, - - - MASS.

R. M. GUILFORD.

FRANK H. WARREN.

R. M. GUILFORD & CO.,

LIVERY,

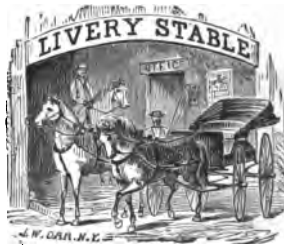

BOARDING,

And Feed Stable.

Good Teams to let at reasonable prices, with safe drivers. All orders left at Mansion House will receive prompt attention. Telephone connection.

Cor. Pearl Street and Strong Ave., opp. Conn. R. R. Depot,
NORTHAMPTON.

**J. B. SIMPSON,
CONCRETE PAVER.**

Streets, Sidewalks, Street Crossings,
Driveways, Private Walks, &c.

IMPORTED ROCK ASPHALT FLOORS

For Dwelling House Cellars, Laundries, Breweries, Stables,
Stores, Mills, Rinks, &c.

Easthampton Headquarters at Frank P. Newkirk's Hardware Store.

Northampton Headquarters at Mansion House.

Home Office, Newton, Mass.

GEORGE W. SHAW,

— PRACTICAL —

VETERINARY SURGEON.

DENTISTRY OF HORSE'S TEETH A SPECIALTY:

EXAMINATION FREE OF CHARGE.

Office at Dickinson & Pomeroy's Stable, Center Street, rear
Northampton National Bank.

Will be at the above Stable every Tuesday.

RESIDENCE

— SOUTH AMHERST.

H



I. N. TAYLOR,
Sale and
Livery Stable.

15 MASONIC STREET,
 NORTHAMPTON, - MASS.

❖ **H. WHITCOMB,** ❖

Livery, Feed and Boarding Stable

Hacks or Private Teams can be
 had at Short Notice.

Main, cor. State Street

NORTHAMPTON, - MASS.



H. G. HOLLEY,
Boarding, Livery, Feed & Hack Stable

Good Teams to let at Reason-
 able Rates, with Safe
 Drivers.



206 Main St., opp. Masonic Street,
 NORTHAMPTON.

ROBERT M. WELCH,
EATING HOUSE

— AND —

Restaurant.

MEALS and LUNCHES AT ALL HOURS

TODD'S BLOCK, MAIN ST.,

NORTHAMPTON.





THOMAS G. WHITELOCK,

DEALER IN

Foreign and Domestic Cigars.

Fine Cut and Navy Tobaccos.

Also, a fine assortment of Smokers' Articles generally.

MANSION HOUSE BLOCK, 127 MAIN STREET,

NORTHAMPTON, - - - MASS

CHARLES N. GABB,

MANUFACTURER AND DEALER IN

Foreign and Domestic Cigars

No. 121 Main Street,

NORTHAMPTON, - MASS.

WILLIAM McCANDLESS,

Wholesale and Retail Dealer in Choice

Wines, Liquors and Cigars

BOTTLER OF ALE AND LAGER BEER.

Agent for Warren Line Steamships.

Masonic Street, near Main Street, - NORTHAMPTON.

P. H. DEWEY, Agent,

DEALER IN

Liquors, Wines, Ales, Porter,

And Lager Beer in Kegs and Bottles.

BOTTLER OF ALE, LAGER BEER, SODA, &c.

141 Main Street, Northampton.

JAMES PARNELL'S
BILLIARD HALL!



THE MONARCH

11 Pleasant Street.

Northampton, - Mass.

Choice Refreshments and Cigars.



BRUNO RUDER,
Lager Beer Saloon

AND RESTAURANT.

CHOICE WINES AND LIQUORS.

Cigars and Tobacco constantly on hand.

No. 4 King Street, Northampton, Mass.

Germania Singing Society
CLUB HOUSE

JOHN BERNHARDT, Manager.

Good accommodations for regular and transient
boarders. Table board and lodgings at
reasonable rates.

Corner Court and King Streets,

NORTHAMPTON,

- - MASS.

✧ **A. HANRAHAN,** ✧

Agent for Western Massachusetts of

Geo. Ehret's Lager Beer,
IN KEGS OR BOTTLES.

Lyman Street, - SPRINGFIELD, MASS.

Orders by Telephone promptly attended to.

GEO. EHRET brewed and sold in the season of 1882, 260,152 Barrels of Lager Beer, being the largest business done by any brewer in the United States.

THIS FACT SPEAKS FOR ITSELF.

S. DANA HAYES, of Boston, State Assayer and Chemist, speaks as follows as to the purity and quality of this brand of beer :

A. HANRAHAN, Esq., Springfield :

No. 4 STATE STREET, BOSTON.

Sir.—I have analyzed a sample marked "Geo. EHRET'S LAGER BEER," received from you with the following results : It contains 53-10 per cent. of alcohol, and one pint contains an ounce and a quarter (600 grains) of malt and hop extracts, free from adulterating constituents or deleterious substances. This Lager Beer is pure, thoroughly fermented, and of excellent quality.

Respectfully,

S. DANA HAYES,

State Assayer and Chemist, Massachusetts.

A LIBERAL DISCOUNT TO THE TRADE.

PRICE, LEE & CO.'S
NEW ENGLAND RAILWAY GUIDE

ISSUED MONTHLY.

Containing Official Time Tables of all Railroads
in New England.

PRICE ONE DOLLAR PER YEAR.

SENT TO ANY ADDRESS.

SINGLE COPIES TEN CENTS.

PRICE, LEE & CO., Publishers,

Yale Bank Building,

NEW HAVEN, CT.

◆ THE ◆

Easthampton News and Enterprise

Newsy! Wide Awake! Independent!

Price, \$1.00 per year.

Started without a pledged subscriber or advertiser, this paper has been conducted on the principle of meeting a real want, and giving every man his money's worth, a policy which has led to most encouraging success.

Just the Paper for Advertisers!

Its circulation in town is equal to one copy for every nine inhabitants, besides which it has a large circulation in neighboring places, and is very popular with people who have moved away from this vicinity, but still keep up an interest in local happenings.

Headquarters for Job Printing.

We have a splendid equipment of presses, type, etc., formed by uniting two well furnished offices, to which we are constantly making additions. Having an abundance of good tools and other conveniences to work with, we are enabled to compete successfully with first-class city offices. Everything has been put in good order and we are—Ready for Business!

“QUICK, NEAT AND CHEAP,” is our Motto.

✉ SEND FOR ESTIMATES.

TORREY BROTHERS.

Williston Mills,

MANUFACTURERS

FIRST QUALITY

COTTON YARNS.

President, Franklin W. Pitcher, - - Boston, Mass.
Treasurer, Henry C. Morse, - - " "
Selling Agent, Henry C. Morse, - - " "

Office,—Boston, 173 Devonshire Street.

Isaac H. Russell, Resident Agent.

Albert E. Abbott, Paymaster.

— MILLS AT —

EASTHAMPTON, - - MASS.

EASTHAMPTON
RUBBER THREAD CO.

— MANUFACTURERS OF —

Rubber Thread.

Payson Street at R. R. Crossing,

EASTHAMPTON, - - MASS.

H. G. KNIGHT,	PRESIDENT.
E. THOS. SAWYER,	TREASURER.

GLENDALE ELASTIC FABRICS CO.,

EASTHAMPTON, - - MASS.

MANUFACTURERS OF

Elastic Goring

FOR CONGRESS BOOTS.

In hundreds of styles and qualities, from the very best to good low-priced goods, but not the meanest.

SPECIAL CARE TAKEN TO FURNISH ONLY FRESH MADE AND RELIABLE GOODS.

Our new **WORSTED GORING**, in fine and common quality, are **THE VERY BEST GOODS FOR SERVICE** offered the trade.

With our superior facilities, we can furnish goods promptly from the looms, saving the great risk of getting old webs or those of uncertain age.

S. T. SEELYE,	PRESIDENT.
JOS. W. GREEN, Jr.,	TREASURER.
I	

Williston & Knight Co.,

MANUFACTURERS OF



Covered Buttons,



And Vegetable Ivory Buttons.

WAREHOUSE IN NEW YORK.

Williston & Knight Co.,

P. O. Box 3667,

— WHO ALSO REPRESENT THE —

Ridgewood Button Co., and the

West Haven Buckle Co.,

And are Importers of Button Stock.

Covered and Ivory Buttons and Buckles are made in every desirable style by these Companies, and are sold by the principal dealers in Tailors' Trimmings, Notions, and Dry Goods in the United States and Canada.

Nashawannuck Mfg. Co.

MANUFACTURERS OF



SUSPENDERS



Elastic Frills and Webs.

EASTHAMPTON,

MASS.

C. MYERS,	PRESIDENT.
G. H. NEWMAN,	TREASURER.
E. D. CANDEE,	SELLING AGENT.
G. H. LEONARD,	MFG. AGENT.

*WAREROOMS,—74 and 76 Worth Street, N. Y.
BOSTON OFFICE,—85 Chauncey Street.*

EASTHAMPTON PAPER CO.

MACHINE FINISHED.

BOOK AND SPECIALTIES.

EASTHAMPTON, MASS.

C. A. CROCKER, - - - Treasurer and Agent

GEO. S. COLTON,

MANUFACTURER OF

SHOULDER BRACES

AND SUPPORTERS.

Easthampton, - - - Mass.

MARTIN RICH,

Brick Manufacturer.

Bricks for building purposes furnished at short notice.

In connection with my Brick business, I run a

Custom Saw-Mill,

Where all work will receive prompt attention. Prices reasonable.

Yard and Mill, Clark St., near Mountain St., - EASTHAMPTON.

RUST, WILSON & CO.,

— DEALERS IN —

Dry Goods, Millinery,

Fancy Goods, Carpets and Oil Cloths.

HATS AND CAPS, GENTS' FURNISHING GOODS,

READY-MADE CLOTHING

For Men and Boys.

Samples of Woolens of the Latest Styles, constantly on hand,
made up to order and guaranteed to fit. All at
Popular Prices.

27 and 29 Main St., opp. Williston Seminary,

EASTHAMPTON, - - MASS.

PRICE, LEE & CO.'S
NEW ENGLAND RAILWAY GUIDE

ISSUED MONTHLY.

Containing Official Time Tables of all Railroads
in New England.

☞ **PRICE ONE DOLLAR PER YEAR.** ☛

SENT TO ANY ADDRESS.

SINGLE COPIES TEN CENTS.

PRICE, LEE & CO., Publishers,

Yale Bank Building, - - NEW HAVEN, CT.

J. E. LAMBIE & CO.,

CASH DEALERS IN

Dry Goods and Millinery,

Dress Goods, Silks and Fancy Goods, Corsets,
Gloves, Hosiery, &c.

53 and 55 Main Street, - - EASTHAMPTON.

H. D. BRIERLEY & CO.'S

CASH STORE.

DEALERS IN FOREIGN, DOMESTIC AND FANCY

→ **DRY GOODS.** ←

GOULD'S BLOCK, UNION STREET,

EASTHAMPTON, - - - MASS.

E. W. WOOD,

Dry Goods and Groceries,

Hardware, Medicines,

Hats, Caps, Boots and Shoes, Ready-made Clothing, &c.

Customers will find our Stock complete, comprising many articles it is
impossible here to enumerate, and all sold at moderate prices.

Union Street, - - - EASTHAMPTON.

L. M. PRESTON,

MERCHANT TAILOR

— AND DEALER IN —

Ready-made Clothing,

HATS, CAPS AND GENTS' FURNISHING GOODS.

39 Main Street, Easthampton.

G. H. McCANDLESS,
Millinery and Fancy Goods

— ALSO, —

PIANOS, ORGANS AND SEWING MACHINES.
5 Union Street, - - - **EASTHAMPTON.**

FRED L. CLARK,
TEACHER OF
Piano, Organ & Harmony
P. O. BOX, 147.
EASTHAMPTON, - - - MASS.

F. G. MORRIS,
TEACHER OF
Short-hand Writing.
The best instruction given orally or by mail.
Mr. MORRIS has had much practical experience in the art, has long taught it with success, and fully warrants his instruction to be as good as can be had. Circulars and full information may be had on application, personally or by mail, and the fullest examination of his method is solicited.
RESIDENCE AND P. O. ADDRESS,
EASTHAMPTON, - - - MASS.

C. B. JOHNSON,
Insurance and Real Estate Agent.
CONVEYANCER
And Justice of the Peace.
Office over the First National Bank,
EASTHAMPTON, - - - MASS.

C. J. SMITH,
Druggist & Apothecary.

— DEALER IN —



**Paints, Oil, Glass,
 PATENT MEDICINES, &c.**

Physicians' Prescriptions care-
 fully compounded from
 best of drugs.

PUBLIC TELEPHONE OFFICE.

Winslow's Block, 45 Main Street, - EASTHAMPTON.

FRED J. GAUGH,

DEALER IN CHOICE

Confectionery, Fruit, &c.

A Good Line of Daily and Weekly Papers, Periodicals &c.

LICENSED AUCTIONEER.

19 Union Street, - - - EASTHAMPTON, MASS.

W. A. JUDD & SON,

MANUFACTURERS OF

Fine Custom Harnesses,

AND DEALERS IN

Horse Furnishing Goods, Trunks, &c.

Also, Boots and Shoes made and repaired.

Union Block, 35 Main Street, . EASTHAMPTON.



B. P. OWEN,

— DEALER IN —

Stoves, Ranges, Furnaces,

— AND —

House Furnishing Goods.

Plumbing and Hot-Air Furnace Work a
Specialty.

Orders by Telephone promptly attended to,

Union Street, near Depot,

EASTHAMPTON.



Fertilizers, Akron Drain Tile, Wooden Ware, &c. A full
line of Stoves, Ranges, Furnaces, Lead and Iron Pipe
Fittings, &c. All kinds of Jobbing, Plumbing, Lead,
Iron and Gas Fitting, done with dispatch.

Store and Shop, 59 Main Street, - EASTHAMPTON, MASS.

WETHERBEE & BEMIS,



MEAT MARKET!

All kinds of Fresh and Salt Meats.

67 Main Street, - - EASTHAMPTON, MASS.

CLINTON W. WETHERBEE.

GEORGE W. BEMIS.

E. H. LUDDEN,

Meat and Butter Market.

FRESH AND SALT MEATS OF ALL KINDS.

LARD AND VEGETABLES.

50 Pleasant Street, Easthampton.



W. C. FERRY,

— DEALER IN —

**Fish, Oysters, Clams,
LOBSTERS, &c.**

33 MAIN STREET,

EASTHAMPTON, - - - MASS.

WM. J. SHEEHAN,

DEALER IN

Staple and Fancy Groceries,

FLOUR, TEA, MOLASSES,

CROCKERY, GLASSWARE, LAMPS AND LAMP GOODS,

OF ALL DESCRIPTIONS.

Agents for Popular Lines of Ocean Steamers. Also, Drafts on England, Ireland and Scotland at lowest rates.

Wholesale Agent for Frank Jones & Co.'s "Portsmouth," and Jones, Cook & Co.'s "Bay State" Ales and Porters, in Bbls., Half and Quarter Bbls., for family use. Bass & Co.'s India Pale Ale, and Guinnesses' Dublin Stout. And bottler of choice brands of Lager Beer.

Money refunded for bottles when returned promptly.

Cottage Street, - - - EASTHAMPTON.

SMITH & JORDAN,

(Successors to STRONG BROS.)

WHOLESALE AND RETAIL

➤: M I L L E R S . :➤

Dealers in Flour, Grain, Meal and Feed.

Near Conn. R. R. Depot, - - - Easthampton, Mass.

T. J. & H. F. POMEROY,



Undertakers and Cabinet Makers.

Dealers in all kinds of Burial Cases, Burial Clothing, &c. Hearse and funeral carriages furnished to order. All kinds of Furniture Repairing will receive prompt attention.

17 Main Street, - - - EASTHAMPTON.

HILL'S MANSION HOUSE.

WM. HILL, *Proprietor.*

W. P. HETHERINGTON, *Manager.*

FIRST-CLASS HOTEL.



WILL ACCOMMODATE 150 GUESTS.

Mr. Hill is favorably known as landlord at Mansion House, Northampton, ten years; and the past twelve years at Easthampton.

TERMS OF BOARD.—\$2.50 per day; from \$8.00 to \$10.50 per week.

Main Street, opp. the Park,

Easthampton, Mass.

GEORGE A. MEIER,

→* **BARBER SHOP** *←

AND

BATH



ROOMS.

Hair Cutting, Shaving, Shampooing, Hot and Cold Baths, &c Particular attention paid to Ladies' and Children's Hair Cutting.

31 Main Street, Merrill's Block,

EASTHAMPTON, MASS.

S. S. FAYHEE,

Manufacturer of and Dealer in

Light and Heavy Carriages.

ALSO, EXPRESS WAGONS.

Repairing and Painting given special attention.

REAR 10 PLEASANT ST., EASTHAMPTON.

E. R. BOSWORTH,
Carpenter, Contractor
AND BUILDER,
AND DEALER IN
Lumber of all kinds.

Union Street, near Railroad Crossing,
EASTHAMPTON, MASS.

→***J. E. CLARK,***←

DEALER IN

Anthracite Coal

OF ALL KINDS.

Egg, Stove, and Chestnut Sizes

ALWAYS ON HAND.

AUCTIONEER AND DEPUTY SHERIFF

For Hampshire and Hampden Counties.



Office at Depot of the N. H. & N. R. R. Co.,

EASTHAMPTON, MASS.

W. E. TOPLIFF, MASON,

AND DEALER IN ALL KINDS OF

Masons' Building Materials.

90 Main Street, Easthampton, Mass.

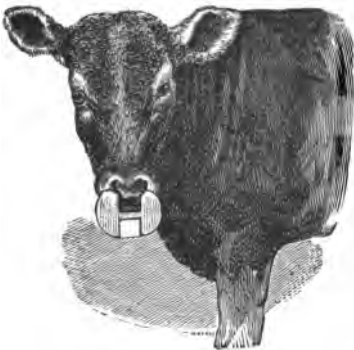

RICE'S PATENT Calf Weaner

— AND —

Sucking Cow Muzzle.

For preventing calves and cows sucking themselves or each other. Does not interfere with eating or drinking. Testimonials and Price List free on application. Address

H. C. RICE,
Easthampton, - - Mass.

ESTABLISHED 1873.

PRICE. LEE & CO.,

DIRECTORY PUBLISHERS,

YALE BANK BUILDING,
Corner State and Chapel Streets, }

NEW HAVEN, CT.

The following Directories published annually at this office:

New Haven, Bridgeport, Norwich, Waterbury, Meriden, Bristol, Plainville, Southington, Derby, Winsted and Torrington, in Ct.; Holyoke, Northampton, Easthampton, Fitchburg, Clinton, in Mass.

Directories of all the principal Cities on file and for sale.

C. F. PRENTICE,

ENTIRELY NEW STYLE OF

SHOW CASES.

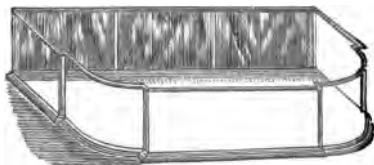

Rosewood, Mahogany, Walnut and Metal Cases, in every Style Old Cases taken in exchange. Bank, Store, Church, and Office Furniture made to order. Jobbing promptly attended to.

Cor. of Dwight and Taylor Sts., 3d floor. - SPRINGFIELD, MASS.

Springfield Planing Mills,

C. S. FERRY, Proprietor.

PLANING, MATCHING,

Brackets, Counters, Window Frames,

◻ BAND AND SCROLL SAWING, TURNING, &c. ◻

MOULDINGS kept in Stock.

House, Store, and Church Finish made to order.

Cor. Dwight and Taylor Sts., - Springfield, Mass.

✧ J. B. KING, ✧

Manufacturer of all kinds of

PAPER BOXES

Druggists' and Jewelers Boxes a Specialty.

Also dealer in Straw and Pulp Boards and Paper Box Makers' Supplies.

52 Taylor Street, - - - Springfield, Mass.

SUBSCRIBE FOR PRICE, LEE & CO.'S

New England Railway Guide.

ISSUED MONTHLY.

Sent to any address for One Dollar per year.

MEEKINS & PACKARD,

OFFER THESE INDUCEMENTS TO THE LADIES OF NORTHAMPTON
AND EASTHAMPTON TO BUY

DRY GOODS

OF THEM.

A Large Store!

A Splendid Light!

A Large Stock!

The Latest Goods

At the Lowest Prices.

Guaranteed to give Satisfaction,

Or the Money Refunded.

MEEKINS & PACKARD,

355 and 359 Main Street, - SPRINGFIELD, MASS.

QUIMBY & DEARDEN,
SPRINGFIELD, MASS.

We have one of the Finest and most Elegant Stores in New England, and are prepared to show a Stock of

CHINA, CROCKERY,

Glass and Silver Plated Ware to correspond.

New and tasteful designs in DECORATED DINNER AND TEA SETS, which are now so fashionable. The finest designs in SILVER PLATED WARE to be found in the city. A full stock of fine VASE LAMPS, HANGING LAMPS, CHANDELIERS, GAS FIXTURES, &c. Also,

PAPER HANGINGS, CURTAINS AND FIXTURES.

Importing our goods direct, having no middlemen's profits to pay, we guarantee our prices to be of the very lowest. Please give us a call before purchasing elsewhere.

QUIMBY & DEARDEN,

328 Main Street, Kinsman's Block, - SPRINGFIELD, MASS.

H. L. BELDIN,

PRACTICAL

BOOKBINDER.

BLANK BOOKS A SPECIALTY.

Library and all Job Work Done in Neatest Manner.

Ruling, Lettering and Gilding.

275 MAIN STREET, SOUTH CORNER OF TAYLOR STREET,
 SPRINGFIELD, MASS.

FORBES & WALLACE

Offer the Largest Stock of

DRY GOODS

In Western Massachusetts,

And call special attention to their Mammoth Stock of

Fancy Dress Goods,

MILLINERY,

Silks, Black Cashmeres, Velvets, Hosiery, Gloves, Cloaks, &c.

BY FAR THE LARGEST ASSORTMENT THEY HAVE
EVER OFFERED, AND AT

☞ THE LOWEST PRICES. ☞

SAMPLES SENT TO ANY ADDRESS.

FORBES & WALLACE,

390 and 392 Main Street, Springfield, Mass.

AGENTS FOR BUTTERICK'S PATTERNS.

EDWIN C. BARR & SON,
Ornamental Confectioners

Ladies' and Gents' Ice Cream and Dining Rooms.

OUR BILL OF FARE COMPRISES ALL THE DELICACIES OF THE SEASON.

☛ HEADQUARTERS FOR BARR'S VIENNA BREAD. ☛

Special Prices to Excursion Parties on Ice Cream at wholesale and retail.

384 Main Street, - - - SPRINGFIELD, MASS.

H. M. CUTLER,
Electric Gas Lighting Apparatus,
 AND ALL KINDS OF ELECTRIC SUPPLIES.
 5 East Court Street, between Market and Main Streets, near Post Office,
SPRINGFIELD, MASS.

SPECIALTIES.—Fitting Private Residences and Business Houses with Electric Gas Lighting and Electric Bells, House and Hotel Annunciators, Burglar Alarms, Speaking Tubes, Automatic Fire Alarms.

JUMP SPARK SYSTEM for lighting Churches, Stores, Theatres, and all public buildings. Agency for the celebrated Prizm Leclanche Batteries. Estimates furnished on application.



The American Watchman's Time Detector and Electric Watch Clock supersedes all others for durability and simplicity of construction.

DRS. HOLT & WALLER, DENTISTS.

Bill's White Block, 352 Main Street,

SPRINGFIELD, MASS.

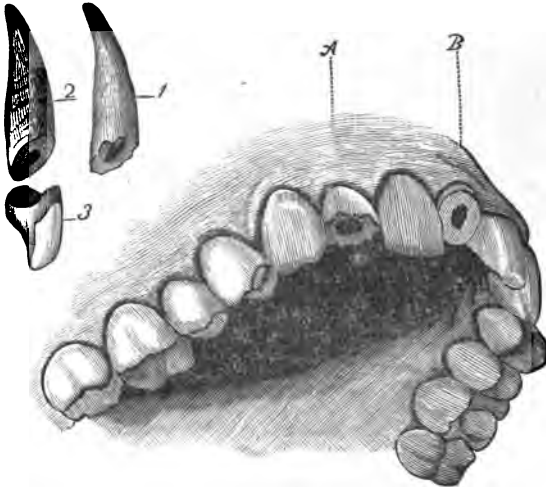

The Greatest Blessing to those suffering from decayed or broken teeth.

Besides this our Specialty, we perform with care and skill every operation known to the Art of Dentistry at Popular Prices.

SEND FOR CIRCULARS.

Artificial Teeth Without Plates, by the Richmond Crown "Process."

SPRINGFIELD CABINET, JOINERY AND JOB WORKS.



D. H. JOYCE, Proprietor.

Factory, Second Floor, New Brick Building, South East Corner Taylor and Dwight Streets.

ALL KINDS OF

Cabinet Work.

Plumbers' Cabinet, Office Desks, Pulpits, Office Tables, Side Boards, Wood Mantels, &c.

Window and Door Screens of the most improved kind, made and put in at short notice.

SPRINGFIELD, MASS.

P. P. EMORY & CO.,

MANUFACTURERS OF THE

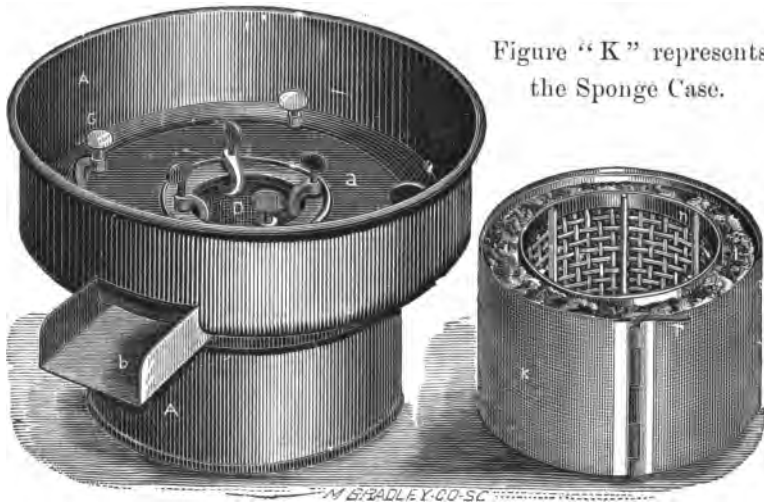
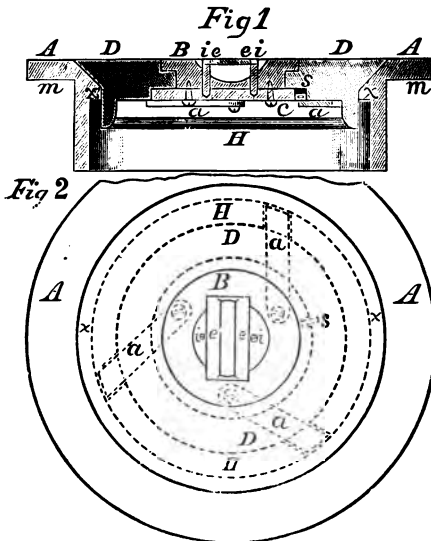

Figure "K" represents the Sponge Case.

Patent Water Filter and Water Tub Combined.

Also of the PATENT LOCK-VALVES for Rag Engines.

[This Valve is admitted by those who use it to be the most perfect Valve in existence.



Particular attention given to lining Rag Engines, with Copper, and to Piping for Paper Mills. All kinds of Brass and Composition Castings.

Also, Copper Work in all its branches.

We are dealers in Sheet Copper, Bolt Copper, Sheet Brass, Brass Rods and Wire, Babbitt Metal, Block Tin, Machine Bolts, etc., etc.

Correspondence solicited.

Address P. P. EMORY & CO.,

48 Hampden St., Springfield, Mass.

COPPERSMITHS AND BRASS FOUNDERS.

One Dollar per year.

Single Copy, Ten

¢ SUBSCRIBE FOR

PRICE, LEE & CO'S

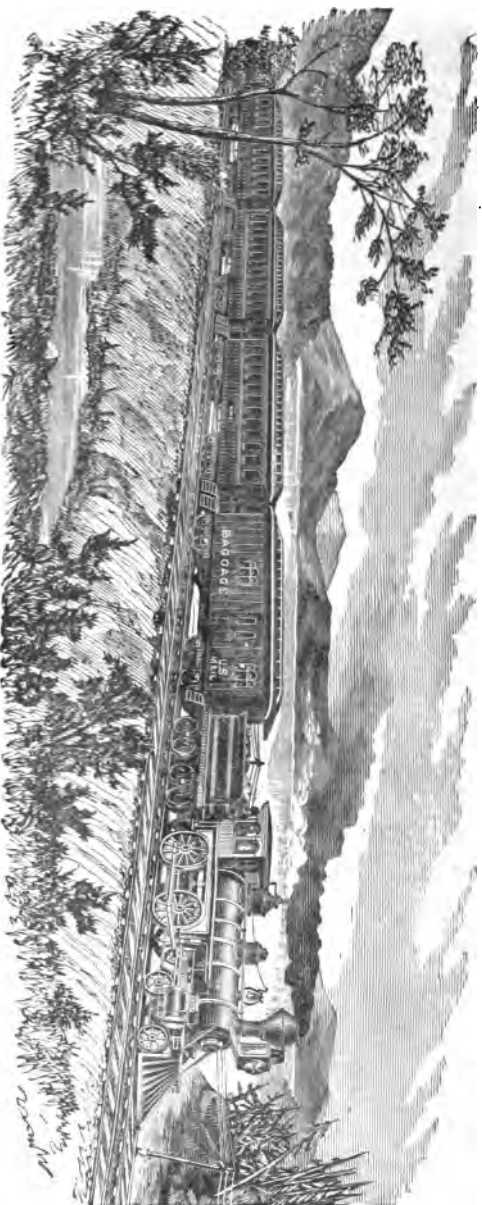

New England Railway Guide

Yale Bank Building, New Haven, Conn.

ESTABLISHED 1831.

CAPITAL, \$1,500,000.

PHILIP L. MOEN, CHAS. F. WASHBURN, CHAS. H. MORGAN,
President and Treasurer. Vice-President and Secretary. General Manager.

WASHBURN & MOEN MANUFACTURING CO. WORCESTER, MASS.

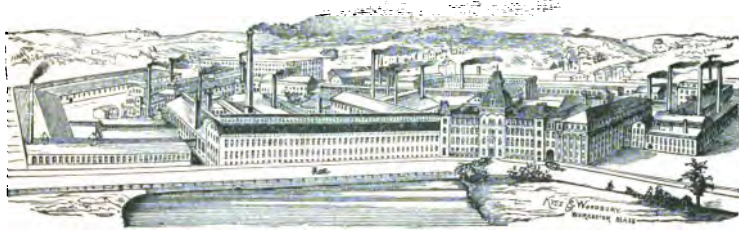

GROVE STREET WORKS, WORCESTER MASS.

WIRE DRAWERS

And Manufacturers of Iron and Steel Wire of every Description.

PATENT STEEL
Barb Fencing.

THE BEST
Fence Material
IN USE.



Proof Against
FIRE, WIND
AND FLOOD.

CHEAP,
STRONG,
DURABLE.

Iron and Steel Telegraph and Telephone Wire.
*Patent Steel Wire Bale Ties, Pump Chains, Chain Wire, Steel
Wire for Springs, Needles and Drills.*

Send for Price Lists, Circulars and Descriptive Pamphlets on our Specialties.

NEW YORK WAREHOUSE,
16 Cliff Street.

CHICAGO WAREHOUSE,
107 & 109 Lake St.

COLLEGE BOOKSTORE!

All Text and Reference Books used in College. Standard Histories, Essays, Poets, Novels, in sets, at

Great Discount from Publishers' Rates.

Sabbath School Books from the leading Publishers. Bibles and Commentaries, a choice assortment. Choice French and American Stationery.

S. E. BRIDGMAN & CO.,

74 and 76 Main Street, - NORTHAMPTON, MASS.

ESTABLISHED 1840.

TINKHAM & CO., Great Dry Goods

— AND —

CARPET STORE.

Drapery and Curtain Goods in full stock.

Contracts taken for Carpets, Draperies and Curtains for Houses.

✧ **CARPETS** ✧

For Churches, Halls and Offices, laid complete if desired.

MATTRESSES AND BEDDING OF ALL KINDS.

First-class Goods at Popular Prices.

432, 434 and 436 Main St., - SPRINGFIELD, MASS.



BOUND BY
HENRY CHILDS,
NORTHAMPTON,
MASS.



HENRY CHILDS,

**Book Paper
Binder, Ruler,**

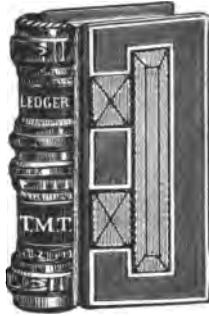

— AND —

Blank Book Manufacturer.

Magazines and Old Books bound in plain or elegant style.

74 Main St., over S. E. Bridgman & Co., Northampton, Mass.

C. A. MAYNARD,

WHOLESALE AND RETAIL DEALER IN

Flour, Grain,

AND COAL.

130 and 132 Main Street,

NORTHAMPTON,

MASS.